

1999-2007
KLM11153
KLM11146
KLM11959
KLM11241



2008
KLM15701
KLM15702
KLM15703
KLM15704

2686 Highway 92 - Oskaloosa, IA 52577
phone: 641.673.0468 - fax: 641.673.4168
www.kelderman.com

1999 & Newer Ford F-250 / 350 4WD 4-Link Rear Installation Instructions



Installation

1. Before doing anything, measure the pinion angle and write the angle down. This is important because you will need to put the axle back to this measurement after the installation. NOTE: Removing the bed makes the install much easier. If you have the resources to remove the bed, we recommend it.
2. Remove the leaf springs. It is helpful to use a motorcycle strap to hold the differential in place while doing the installation. Set the bolts aside that hold the front of the leaf spring in place. This bolt will fasten the upper trailing arm in place **(1.0)**.



3. Remove the overload pads. The some of the pads are bolted on, while others are riveted on. The best way to remove the riveted pads is to use a torch to cut the rivet heads off. Make sure that there are no fuel lines, brake lines, or wiring that can be damaged while cutting the rivets off (1.1 & 1.2).



4. Locate the front trailing arm mounts. Place the mounts on the frame and use a clamp to hold them in place. On long box models, use the two 1" holes in the plates to go over the bolts that stick out of the frame. On the short box the cut out goes around the box mount. You will need to drill 2-3 holes in the side of the frame and 2 holes in the bottom of the frame for the 1/2" bolts to go through. Use a center punch to indicate where you need to drill the holes. **NOTE:** On the driver's side the fuel tank is right behind the frame. Be sure not to drill into the tank. Also, the fuel lines, brake lines and tail light wires run along the inside of the drivers side frame rail. Pay attention so you don't damage any of these lines. Once you have all the holes drilled, fasten the trailing arm mounts in place with the 1/2" x 1 1/2" bolts. Torque them to 75 lb/ft (1.4-1.8).

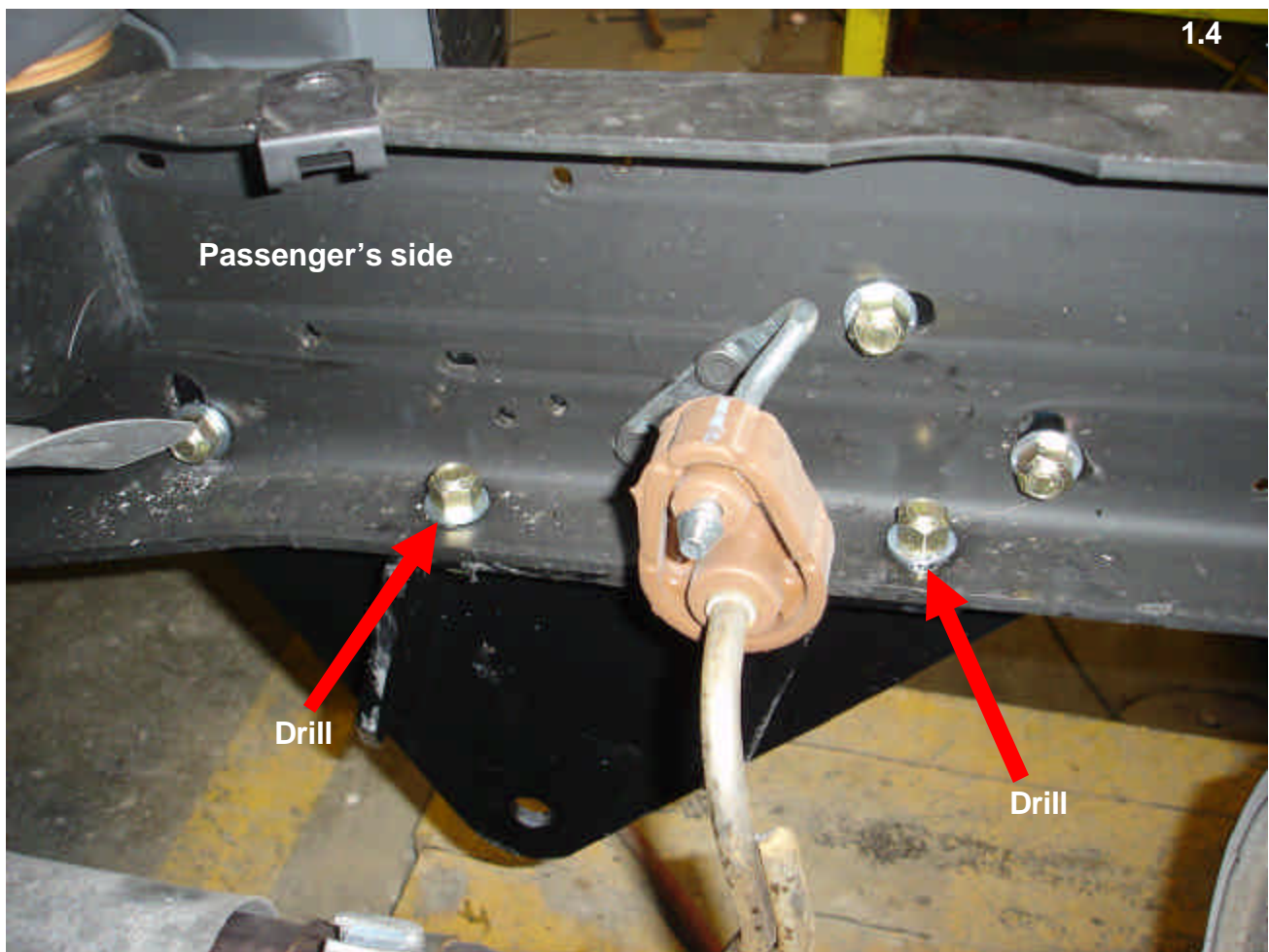

Long Box Pictured

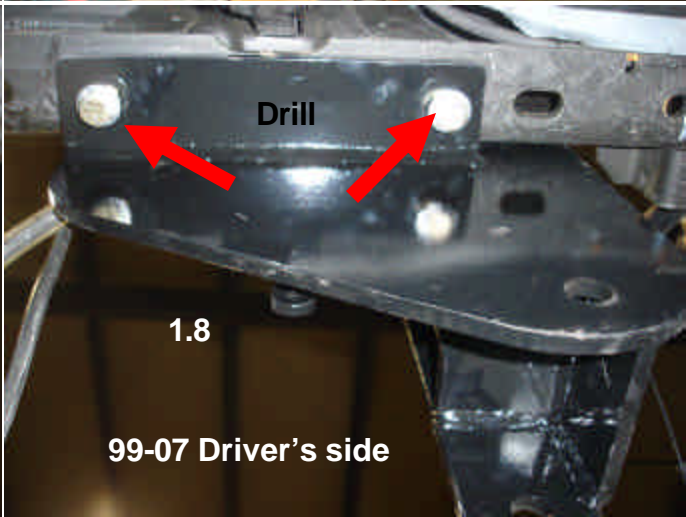
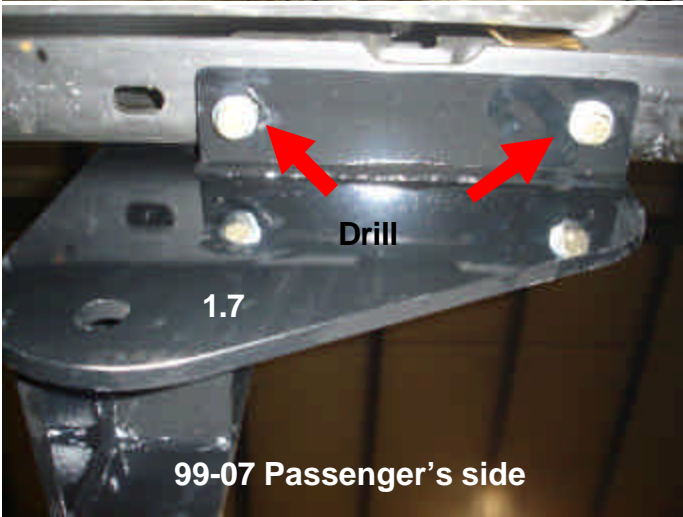
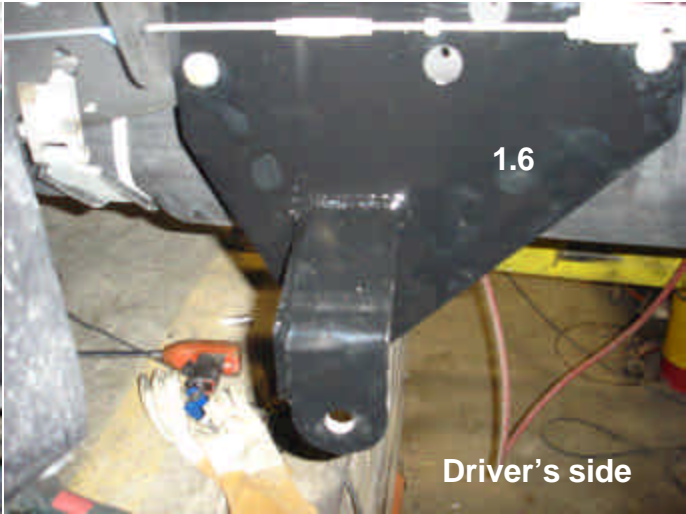
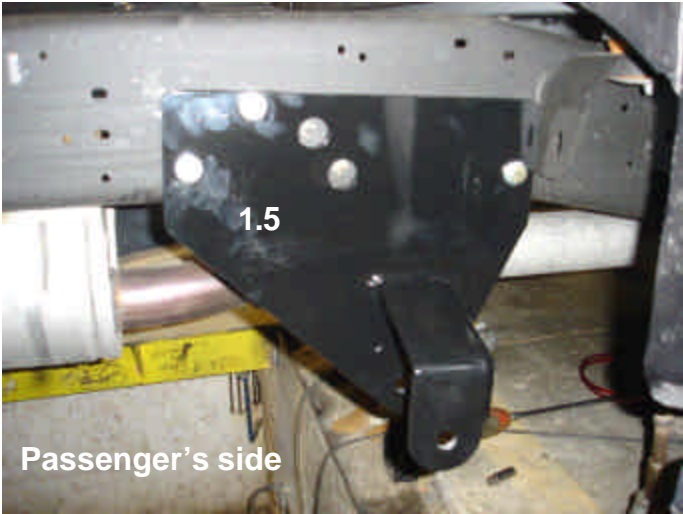

2008 short box

5. Remove the rubber bump stop off the bottom of the frame. Next, locate the upper cross member. The ears that drop down on one end goes on the drivers side. The ears are what the pan hard bar will attach to. Place the cross member straight above the axle. It will require a clamp on each end hold up the cross member while you use a center punch to mark the holes. Use a 1/2" drill bit or slightly larger to drill out the 3 holes. Once the holes are drilled, use the 1/2" x 1 1/2" bolts to fasten the cross member in place. NOTE: If the truck has an aftermarket exhaust and it rubs or hits the cross member, it may be required to shorted up the hangers that hold the exhaust in place in order to have enough clearance to prevent rubbing.

***Aftermarket hitch needed notched to gain access to bolts**

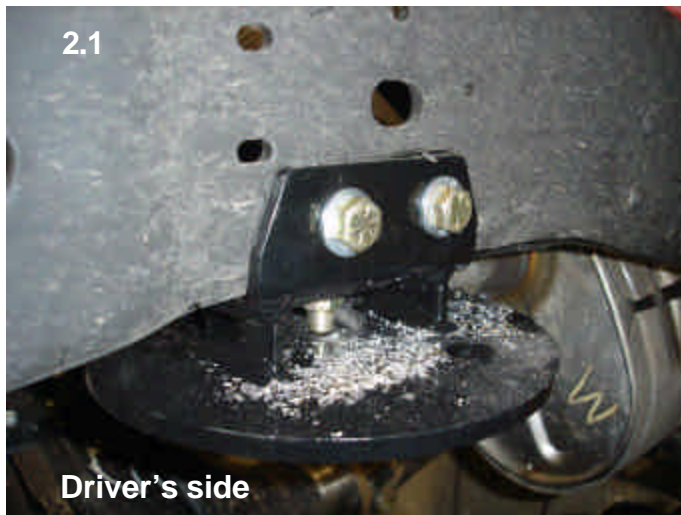
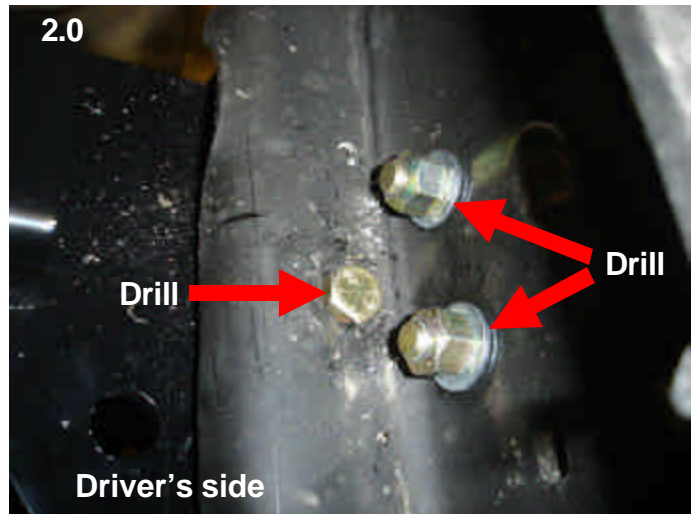
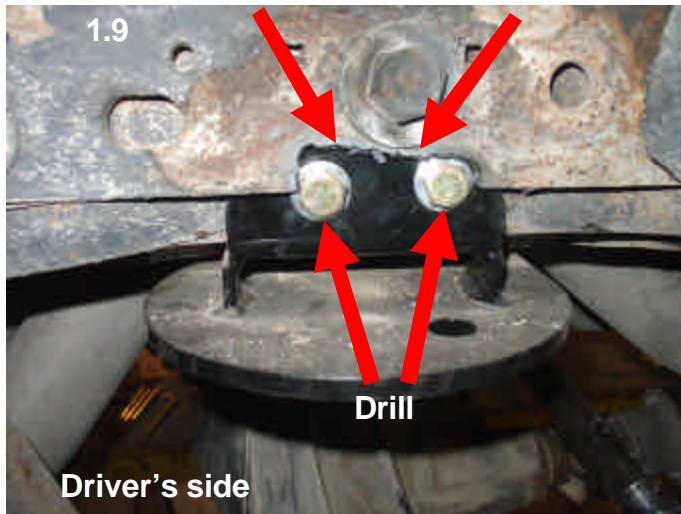

6. Locate the bottom air bag mounts and the bottom axle clamps. The bottom axle clamps also serve as the lower shock mounts. The lower bag mounts sit on top of original leaf spring perches. The passenger's side is the one with the tabs welded to it. This is where the pan hard bar connects. Use the 5/8" bolts (DRW use 9" bolts and the SRW uses 8 1/2" bolts) to fasten the lower bag mounts to the axle. The bolts go from the top down. Locate the lower axle mounts and make sure that the shock mounts sticking out go towards the inside of the truck (2.3-2.9).

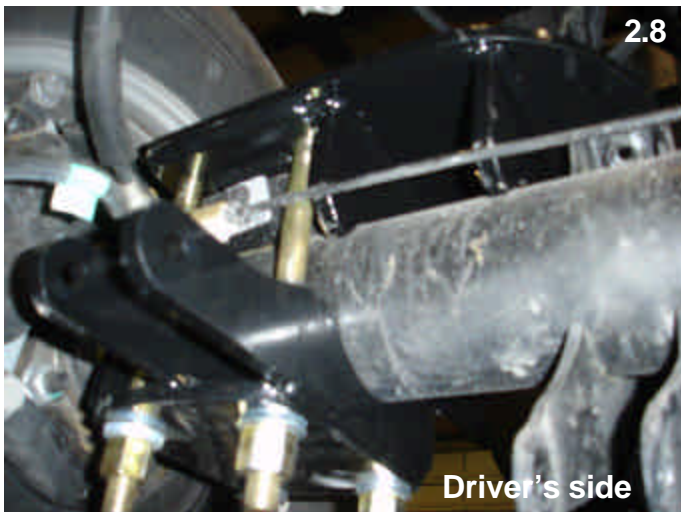

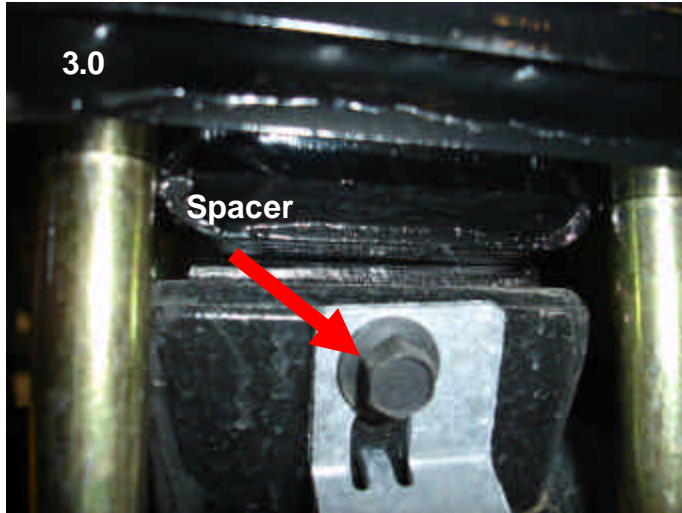

NOTE: On 2008 and new trucks, it will be required to open up the leaf spring hanger with a die grinder in order to get the 7/8" bolt through. (5.0)

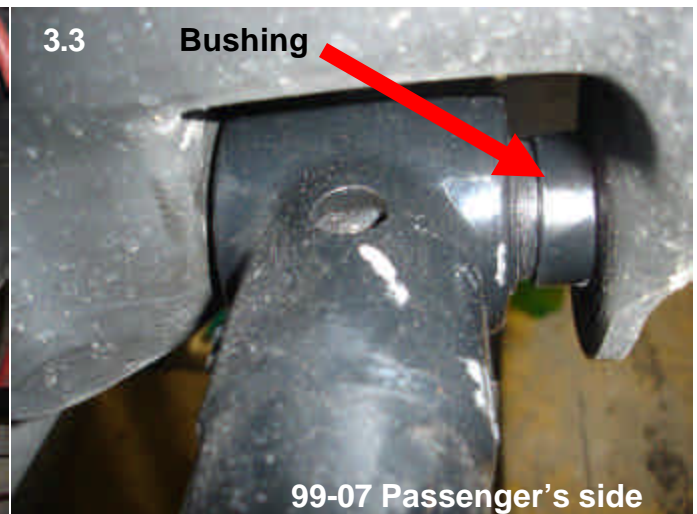
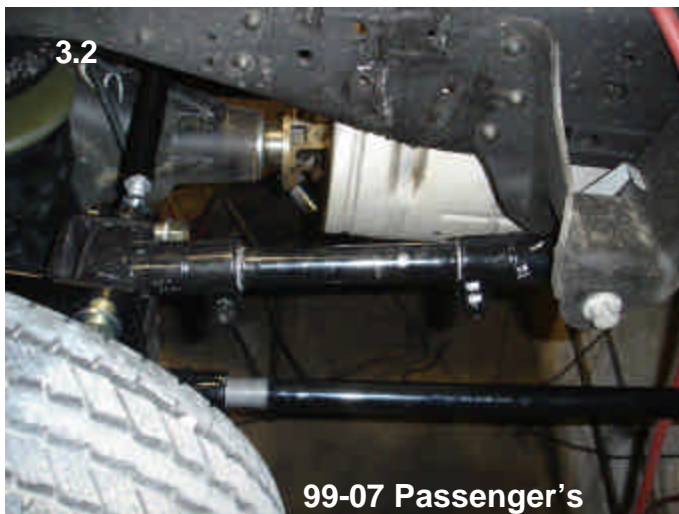
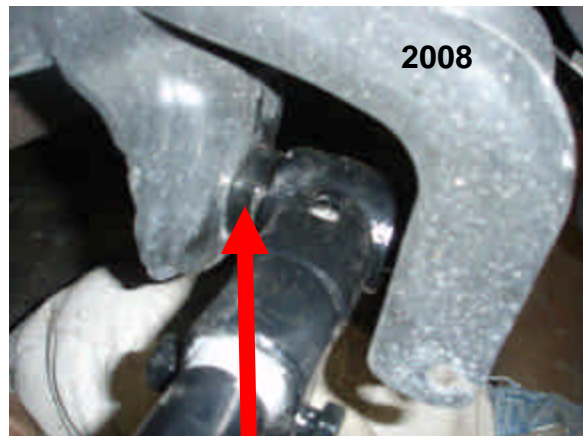

NOTE: On the 2005 and newer dual rear wheel axles, it will require a 1/4" spacer to go in between the lower bag mount and the original leaf spring perch. Failure to put in the spacer will cause the lower bag mount to not sit flush on the axle (3.0 & 3.1).

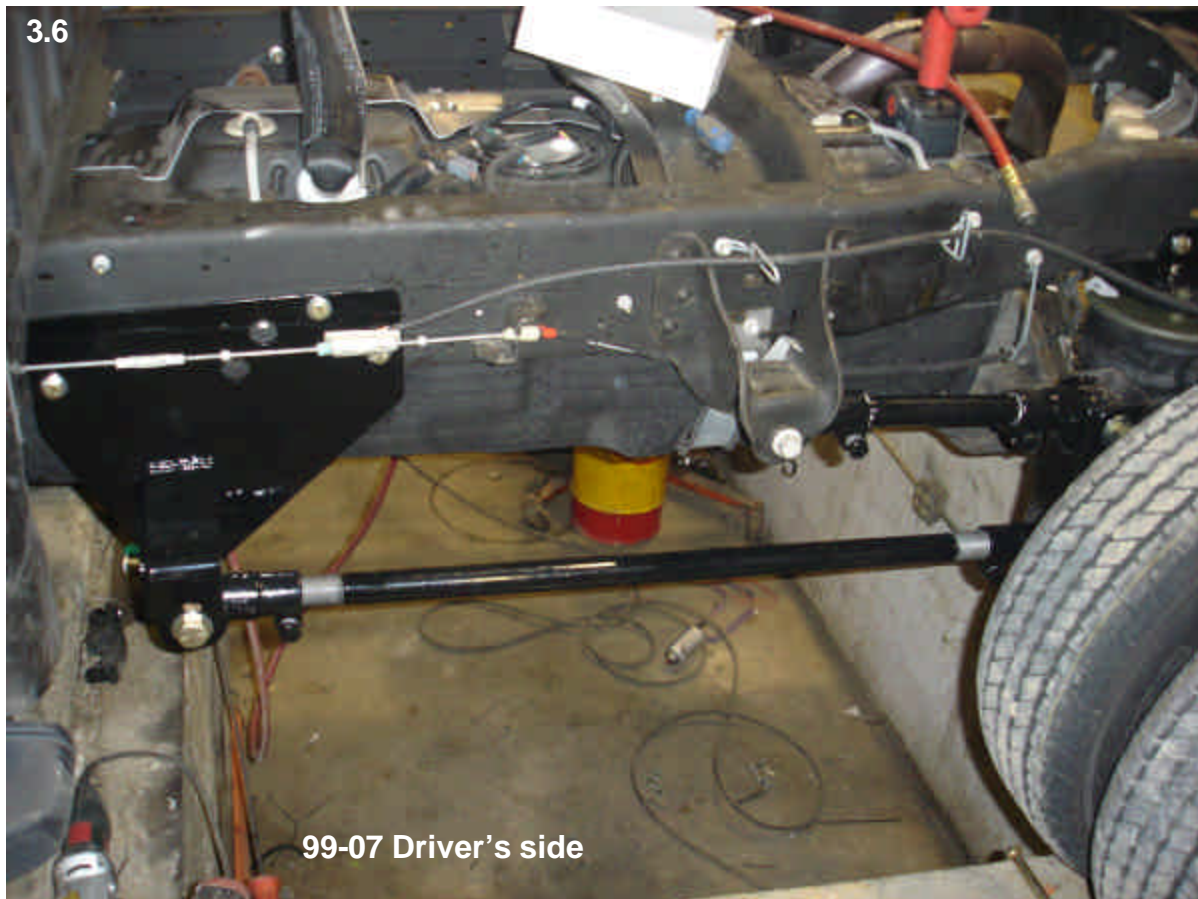



7. Locate the upper trailing arms. Thread the knuckles in so that the center measurement of the holes is about 18 ½" (99-07). Locate step bushing and insert it into one end of the knuckle. This bushing goes into the original leaf spring perch. The step goes towards the outside of the frame. Use the factory bolt to fasten the trailing end in place. Use the 7/8" x 5" bolt on the other end. Place the bolt in from the center of the truck out, so that the nut of the bolt is towards the tire. If you put the bolts on the other way the excess threads will rub on the frame **(3.2 & 3.3)**.



8. Locate the lower trailing arms. Thread the knuckles in so the holes are about 45" apart (99-07). Use the 7/8" x 5" bolts and flat washers to fasten the knuckle on the lower bag mount end and use the 7/8" x 7" on the trailing arm mount. A 1 3/4" spacer goes in between the front trailing arm and the knuckle to get the correct trailing arm spacing **(3.4-3.6)**.
9. Locate the pan hard bar. The pan hard bar has heim ends on each end. Thread the heim ends all the way in and insert the driver's side end on the cross member and the passenger's side end on the lower bag mount. Place a spacer on each side of the heim end and use the 3/4" x 3 1/2" bolts to fasten into place. Go ahead and torque the 3/4" bolts to 100 lb/ft.
10. Locate the 5768 air bags. Slide the air bags in place so that the 3/4" stud sticking out the bottom of the bag fits in the hole in the center of the lower bag plate. Use the 1/2" and 3/4" nuts and lock washers to fasten the top of the air bag in place. Use a blow nozzle to shoot some air in the bag if the bottom stud is not long enough to get the washer and nut on. Locate the 3/4" air fitting and thread it into the top of the bag **(4.0)**.



11. Locate shocks and the upper shock mounts. You will have to drill two 1/2" holes in the side of the frame in order to fasten the shock mount to the frame. Fasten the lower end of the shock into the lower shock mounts with the 1/2" x 3 1/2" bolts. Extend the shock up fasten upper shock mount to the top shock eye with the 1/2" x 3" bolt. Set the shock mount against the frame so the top of the mount is flush with the top of the frame. Mark the holes and drill them with a 1/2" drill bit. NOTE: Make sure not to drill into any wires or fuel lines when drilling in the frame. Once the holes are drilled fasten the upper shock to the frame with the 1/2" x 1 1/2" bolts. Next fasten the shock into the shock mount with the 1/2" x 3" bolt. **(4.3-4.6)**

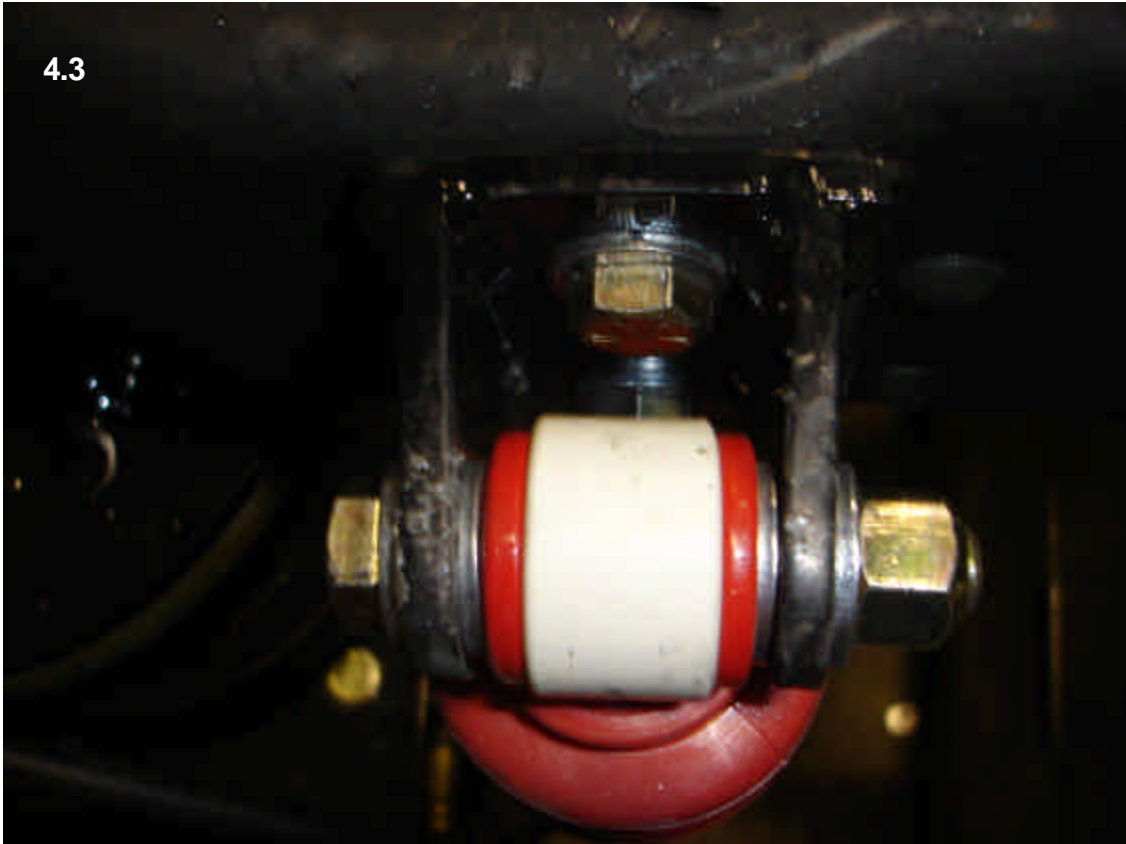

4.3



Driver's side



Passenger's side



Passenger's side

12. Locate the accumulator tanks. The accumulator tanks are the small one-gallon tanks. They are held in place with the original shackle bolt in the original shackle hanger. 3/4" line is used in between the bag and the accumulator tank. 1/4" line is used from the height control valve or dump solenoid. What the accumulator tanks do is change the spring rate of the bag by allowing some of the air to escape from the bag when you hit bumps. This allows the truck to ride smoother (4.1 & 4.2).

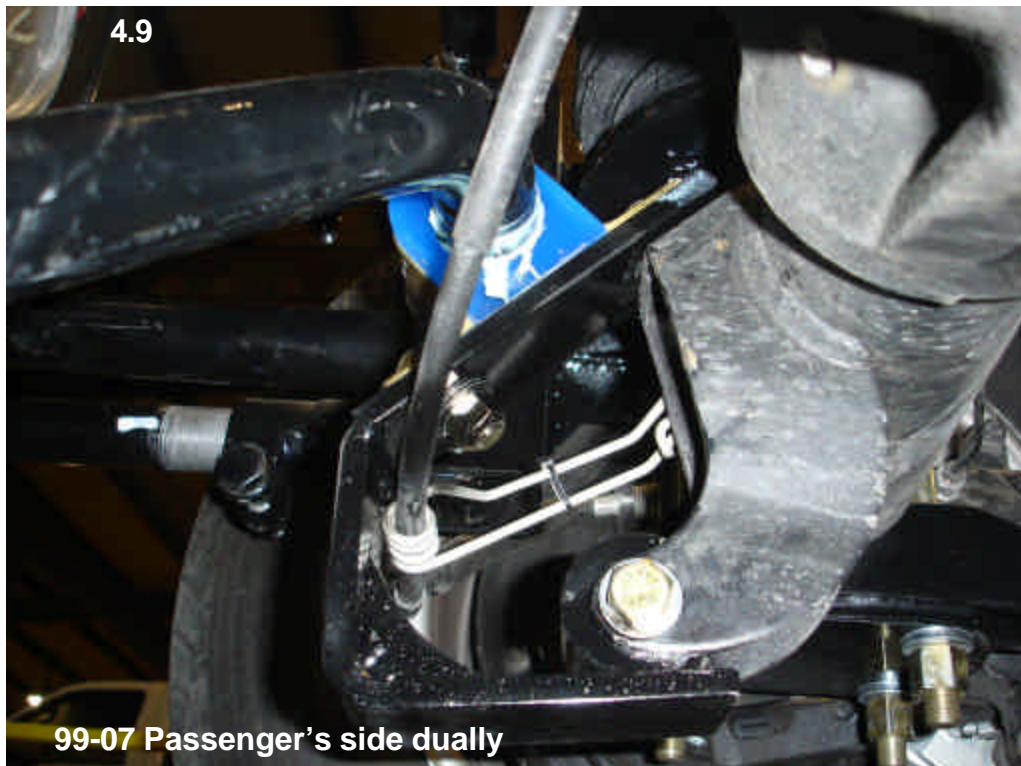
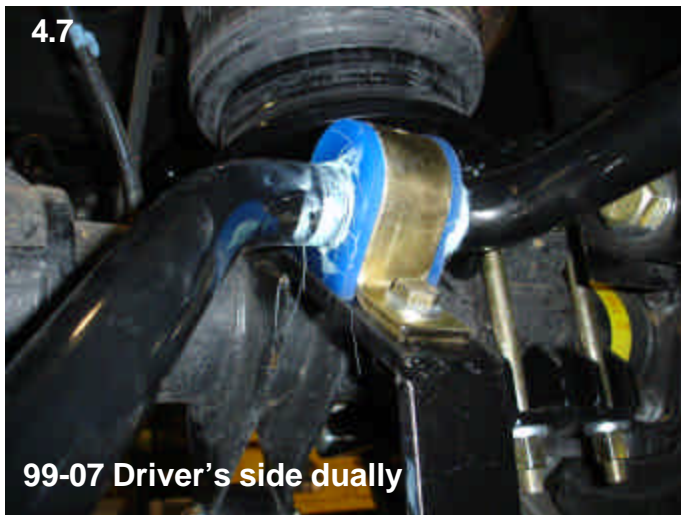

13. Locate the sway bar. The SRW (single rear wheel) and the DRW (dual rear wheel) axles use different sway bars. Pictured below is the DRW sway bar kit. Locate the sway bar mounting brackets. On the DRW kit, use the 1/2" x 3" bolt to fasten the bushing end of the mount into the original shock mount. Locate the sway bar, sway bar bushings and clamps. Fasten the clamp and bushing to the sway bar mount with the 7/16" x 1 1/2" bolts. The bolt closest to the axle actually goes through the original factory hole in the shock mount. Locate the sway bar end links. You will have to drill out the hole in the frame to 1/2". Use the picture below to identify the hole to drill. Use the 1/2" x 3" bolt with the large flat washer to fasten the top link to the frame. Use the 1/2" x 3" bolt and large flat washer to connect the bottom of the end link to the sway bar **(4.7-4.9)**.



2008 sway bar mount

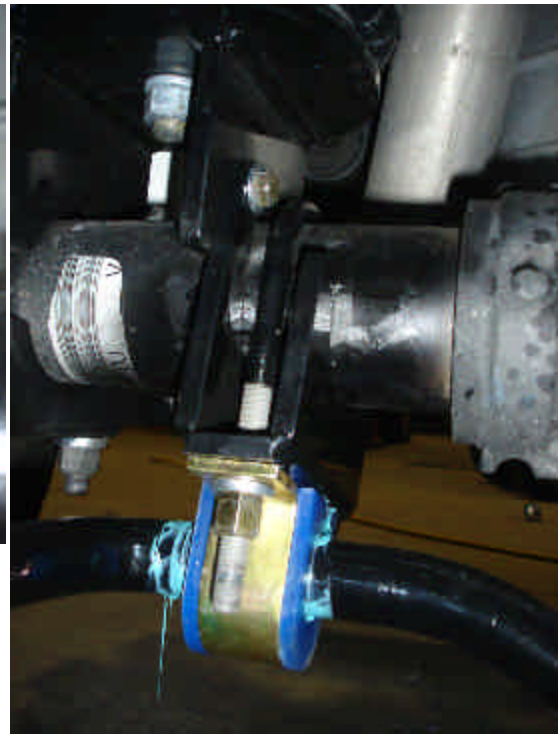

14. Plumbing of the air control system. Locate the compressor box. Fasten it to the inside or outside of the drivers side frame rail. Use the diagram provided to hook up wires. **(5.2)**
15. Locate the air tank. You can fasten it to the frame rail where ever there is room. NOTE: Try and have the outlet of the compressor box higher than the input of the air tank. You don't want any part of the air line to have a low spot in it. This will prevent moisture from settling in the air line and freezing in the winter.
16. Run the 3/8" air line from the compressor box into the air tank. Locate the height control and dump valve. The height control valve fastens to the upper cross member with the 1/4"x1" bolts. The dump valve can be mounted anywhere between the height control valve and one of the accumulator tanks.
17. Locate the height control linkage. You will need to trim the linkage to the correct length. For the best ride set the bags at 7 1/2" inches. Use the 1/4" x 1 1/4" bolts to fasten the linkage to the bottom air bag bracket and the height control valve.



Upper sway bar end link

5.0



5.1

Rear height control valve



5.2

Compressor box

18. Locate the 1/4" air line. Run a line from the tank to the bottom of the height control valve. Next run a line from the middle port of the height control valve to the dump valve. Now run a short line out of the dump valve to a "T" fitting. From the "T" fitting run an air line to each accumulator tank. From the accumulator tank, the 3/4" air line should connect to the air bag. **(5.3)**

ADJUSTING WHEEL BASE / PINION ANGLE

With vehicle lifted to ride height on jack stands, let air out of airbags. Check wheelbase measurement on vehicle. To adjust wheelbase, turn either both left or both right 4-Link Bars. **Always turn them the same direction and only 1/2 turn at a time.** Keep **checking measurement and** adjusting until your wheelbase and pinion angle measurement are the same as initial measurement. Once the alignment is done, torque the pinch bolts on the 4-Link Bars to 100 ft. lbs.

Test drive. Once the system is installed, bolts torqued, and the air system checked for leaks, the vehicle is now ready for a test drive. The vehicle should drive straight and be without any driveline vibration. If there is shutter upon take off, then the pinion angle is off. This can be adjusted by shortening or lengthening the upper or lower trailing arms. If the truck pulls to the right or left, the alignment is off. Adjust by shortening or lengthening the trailing arms on the same side.

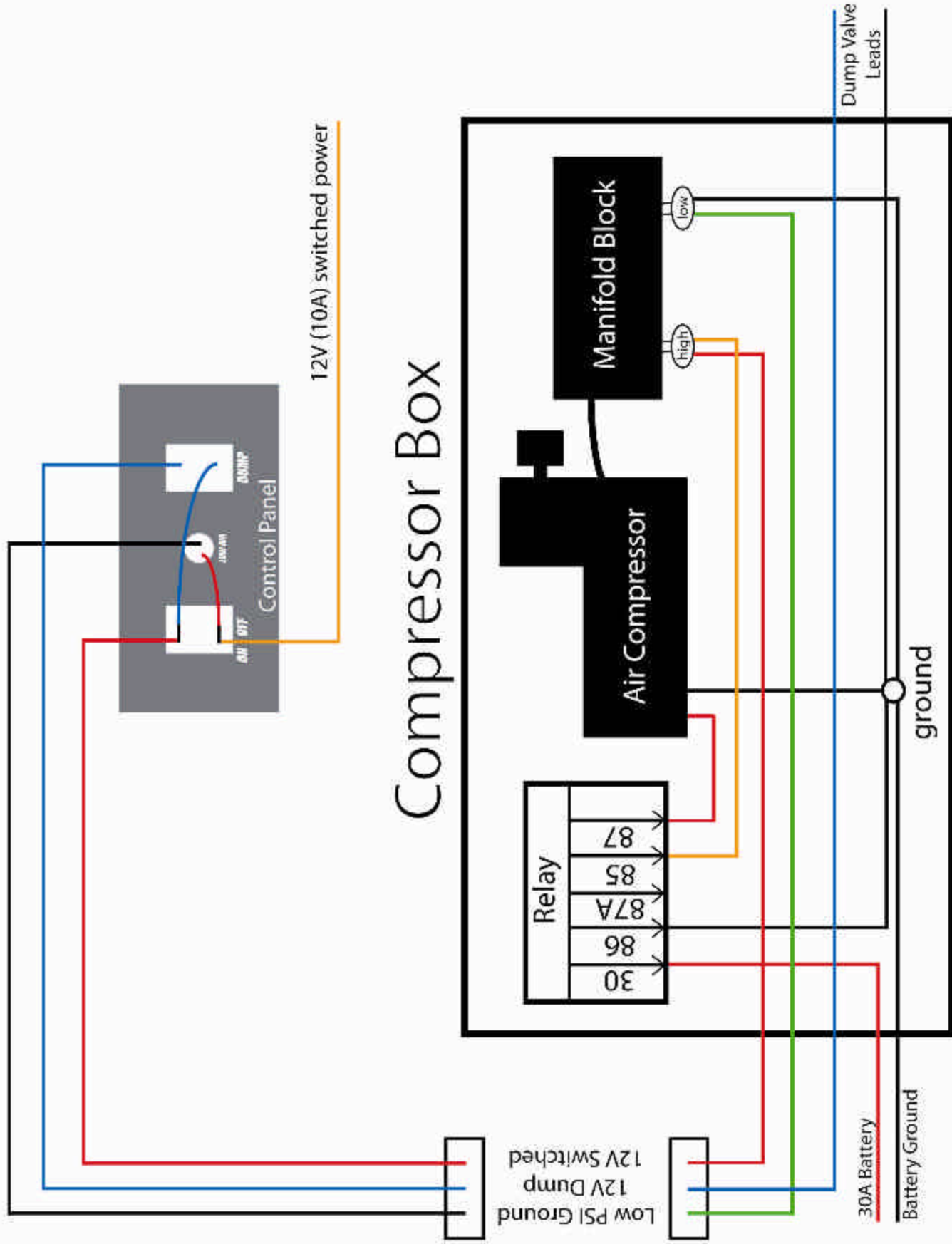

Compressor Box Self-Leveling Kit Wiring Diagram (shown with optional dump valve)

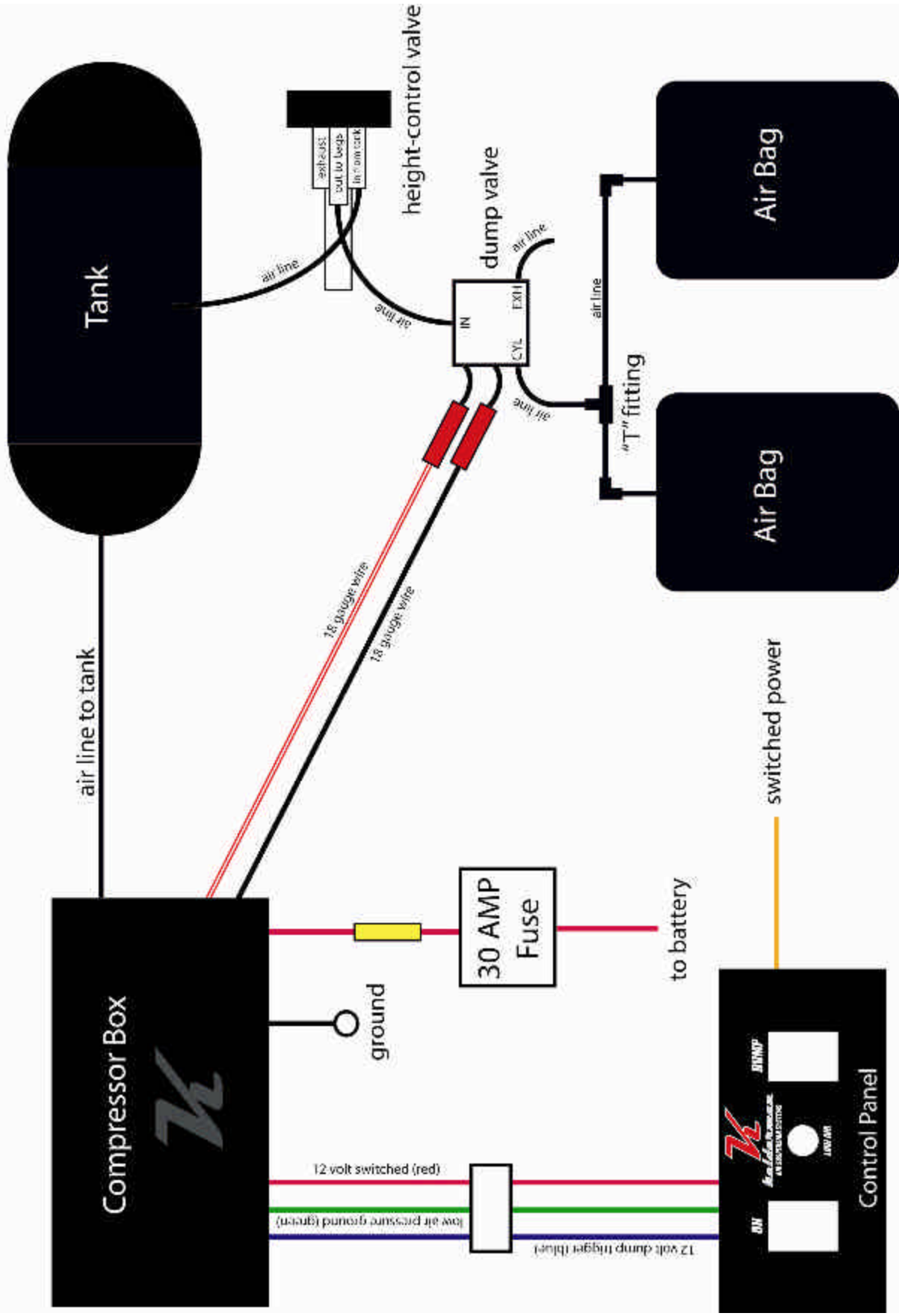

INSTALLATION - FORD F250/350 -0" RH
 FORD-R4L-0-350-LB-D-AUTO-99**

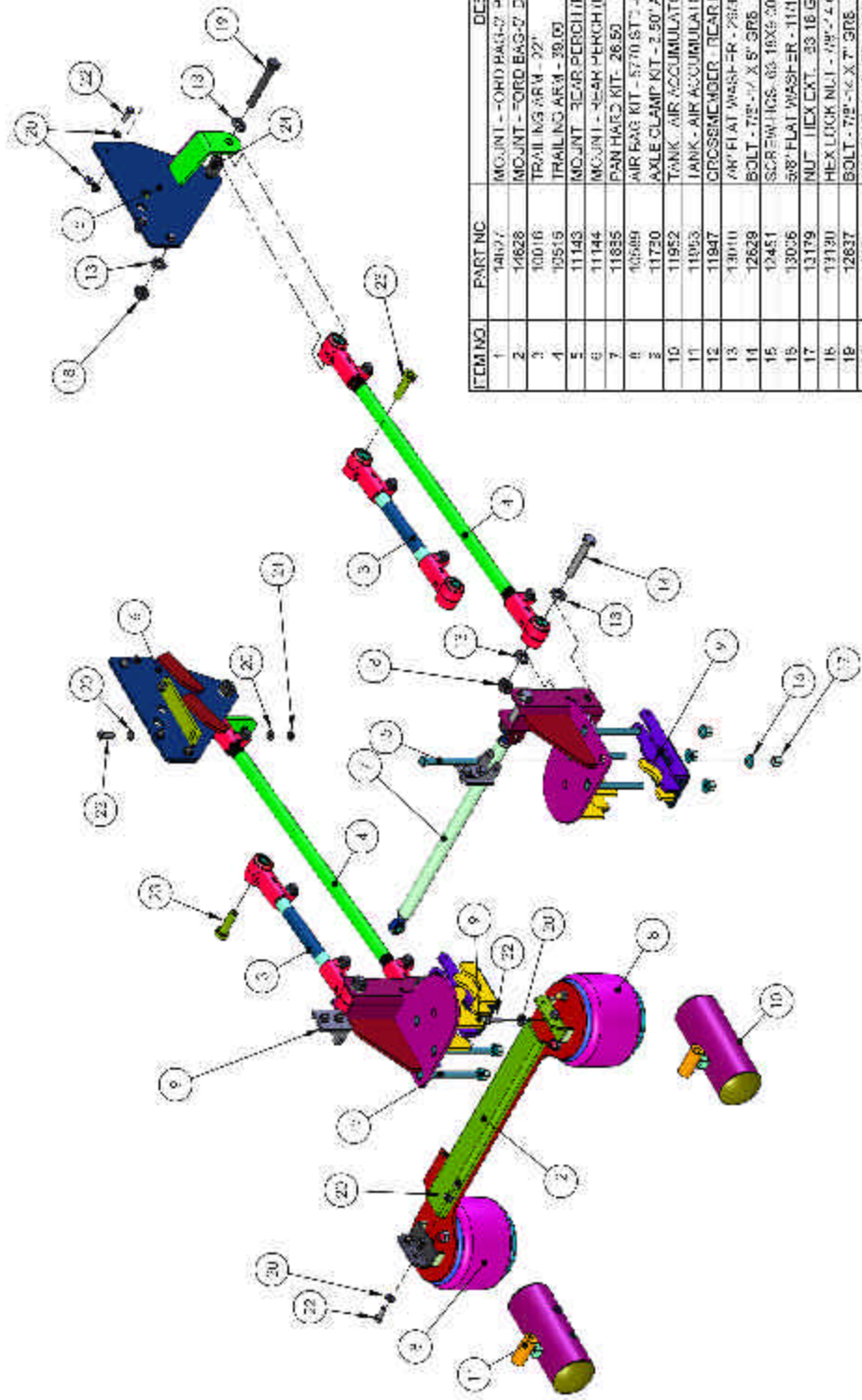

ITEM NO.	PART NO.	DESCRIPTION	QTY.
1	11817	MOUNT - FORD PART-7-98	1
2	14628	MOUNT - FORD BAG-2- D9	1
3	10016	TRAILING ARM - 27"	2
4	10515	TRAILING ARM - 30.00"	2
5	11143	MOUNT - REAR PERCH/PS;	1
6	11144	MOUNT - REAR PERCH (D51)	1
7	11835	PAN HARD KIT - 26.50"	1
8	10249	AIR BAG KIT - 57.00 (ST)-5.075"	2
9	11720	AXLE CLAMP KIT - 2.50" AXLE S NOLE SHOCK	1
10	11952	TANK - AIR ACCUMULATOR	1
11	11053	TANK - AIR ACCUMULATOR	1
12	11947	CROSSMEMBER - REAR DRG	1
13	13010	W/ FLAT WASHER - 28.00" ID X 3.00" OD X 1.00" THK	12
14	12629	BOLT - 7/8" X 5" GR5	4
15	12451	SCREW W/ WING - 8.00 18X5.00 GR5 XZ	8
16	13006	W/ FLAT WASHER - 1.115" ID X 5.15" OD X 3/16" THK	3
17	13179	NUT - HEX EXT. 33 16 GR5 PLN	8
18	13190	HEX LOCK NUT - 1.875" X 1.00"	6
19	12637	BOLT - 7/8" X 2" GR5	2
20	13004	W/ FLAT WASHER - 1.730" ID X 1.115" OD X 1.752" THK	32
21	13124	HEX LOCK NUT - 1.25" X 1.00"	15
22	12037	BOLT - 1/2" X 1.75" GR5	15
23	10211	LUBE - SHAF - SPACER (1.8MT)	2
24	11150	TUBE - SPACER	2