



Installation Instructions



6" Performance Suspension System 2009-2010 Ford F150 4WD Super Crew Cab Only

***Fabtech Motorsports 4331 Eucalyptus Ave. Chino, CA 91710
Tech Line 909-597-7800 Fax 909-597-7185 Web www.fabtechmotorsports.com***



www.fabtechmotorsports.com

*6" Performance Suspension System
2009-2010 Ford F150 4WD
Super Crew Only
FTS22130 / FTS22131*

TOOL LIST: (NOT INCLUDED)

- FLOOR JACK & JACK STANDS
- ASSORTED METRIC AND S.A.E SOCKETS & WRENCHES
- TORQUE WRENCH
- DIE GRINDER WITH CUT OFF WHEEL AND GRINDING WHEEL

READ ALL INSTRUCTIONS THOROUGHLY FROM START TO FINISH BEFORE BEGINNING INSTALLATION! IF THESE INSTRUCTIONS ARE NOT PROPERLY FOLLOWED, SEVERE FRAME, DRIVELINE AND / OR SUSPENSION DAMAGE MAY RESULT.

CHECK ALL PARTS INCLUDED IN THIS KIT TO THE PARTS LIST ABOVE BEFORE BEGINNING INSTALLATION OF THIS KIT. IF ANY PARTS ARE MISSING, CONTACT FABTECH AT 909-597-7800.

NOTE- PRIOR TO THE INSTALLATION OF THIS SUSPENSION SYSTEM, A FRONT END ALIGNMENT MUST BE PERFORMED AND RECORDED. DO NOT INSTALL THIS SYSTEM IF THE VEHICLE ALIGNMENT IS NOT WITHIN FACTORY SPECIFICATIONS. CHECK FOR FRAME AND SUSPENSION DAMAGE PRIOR TO INSTALLATION. THIS SUSPENSION SYSTEM DOES NOT REQUIRE WELDING FOR INSTALLATION. DO NOT WELD ANY OF THESE COMPONENTS.

VEHICLES THAT WILL RECEIVE OVERSIZED TIRES SHOULD CHECK BALL JOINTS, TIE RODS ENDS AND RACK & PINION EVERY 2500-5000 MILES FOR WEAR AND REPLACE AS NEEDED.

DO NOT ALTER THE FINISH OF THESE COMPONENTS, EXAMPLE- CHROMING, ZINC PLATING OR PAINTING. CHANGING THE FINISH CAN CAUSE STRUCTURAL FATIGUE OF COMPONENTS.

THIS SYSTEM MUST BE INSTALLED WITH FABTECH SHOCK ASBORBERS TO PREVENT POSSIBLE BALL JOINT & CV DAMAGE.

THE INSTALLATION OF THIS SUSPENSION SYSTEM SHOULD BE PERFORMED BY TWO PROFESSIONAL MECHANICS.

O.E.M. WHEELS & TIRES CAN NOT BE REINSTALLED WITH THIS KIT. A LARGER TIRE CANNOT BE INSTALLED ON THE O.E.M WHEEL. FABTECH RECOMMENDS AN 18X9 WHEEL WITH A 5" BACK SPACING WITH A 325/65R18 OR 35/1350R18 TIRE. FABTECH ALSO RECOMMENDS A 20X9 WHEEL WITH A 5" BACK SPACING WITH A 35/1350R20 TIRE.

VERIFY DIFFERENTIAL FLUID IS AT MANUFACTURES RECOMMENDED LEVEL PRIOR TO KIT INSTALLATION. INSTALLATION OF THE KIT WILL RE-POSITION THE DIFFERENTIAL AND THE FILL PLUG HOLE MAY BE IN A DIFFERENT POSITION. (FOR EXAMPLE, IF THE MANUFACTURE RECOMMENDS 3 QUARTS OF FLUID, MAKE SURE THE DIFF HAS 3 QUARTS OF FLUID). CHECK YOUR SPECIFIC MANUAL FOR CORRECT AMOUNT OF FLUID.

QTY	PART NUMBER	DESCRIPTION
	FTS22130	6" F150 4WD BOX1
1	FTS30374D	DRIVER SIDE SPINDLE 4WD
1	FTS30374P	PASS SIDE SPINDLE 4WD
2	FT30378	DIFF DROP BRKT UPPER
1	FT30422	DIFF DROP BRKT REAR
1	FT30381	DIFF DROP BRKT CENTER
2	FT30382BK	SHOCK EXTENSION UPPER
2	FT30383BK	SHOCK EXTENSION UPPER
2	FT30384BK	SHOCK EXTENSION LOWER
1	FT30388	HARDWARE SUB-ASSEMBLY
1	FT30377BK	SKID PLATE
2	FT44017BK	IMPACT TUBES
2	FT30064BK	IMPACT TUBES MOUNT
	FT30388	HARDWARE SUB-ASSEMBLY
2	FT20277	TIE ROD END
4	FT1036	BUSHING HALF
2	FT99	SLEEVE 1.250X.813X2.350
4	FT30386	ALUMINUM SHOCK BUSHINGS
4	FT107	SLEEVE .630 X .501 X 1.480
2	FT181	SLEEVE - DIFF MOUNT
4	FT1020	BUSHING
2	FT70032	FRT BRAKE LINE BRK.
1	FT22130i	INSTRUCTION SHEET
1	FT1044	IMPACT STRUT BUSHINGS
1	FT294	ALIGNMENT CAM KIT
2	FT293	ALIGNMENT CAM/BOLT
1	FT292	ALIGNMENT CAM HALF KIT 04 F150
4	FT60	WASHER
2	50180004382	M18-2.5 LOCKNUT
	FTS22131	6" F150 4WD BOX2
1	FT30375BK	FRONT CROSSMEMBER 4WD
1	FT30376BK	REAR CROSSMEMBER 4WD
2	FTBK52	LIFT BLOCK W/BUMPSTOP
1	FT30062BK	SWAY BAR DROP DRV.
1	FT30063BK	SWAY BAR DROP PASS.
1	FT30389	HARDWARE SUB-ASSEMBLY
4	FT737U	U-BOLT
1	FT30390	HARDWARE
	FT30389	HARDWARE SUB-ASSEMBLY
2	FT83159	WASHER
2	FT90056	NUT TAB
1	FT70033	RR DIFF BRAKE LINE TAB
1	FT30387	RR E-BRAKE CABLE BRACKET
1	FT916H	U-BOLT HARDWARE
1	FTAS12	FABTECH STICKER
1	FTLOCK	THREAD LOCKING COMPOUND
1	FTREGCARD	REG. CARD

QTY	PART NUMBER	DESCRIPTION
	FT30390	Hardware Kit
9	31181251081	5/16"-18 x 1-1/4" Hex Cap Bolt
2	31181001081	5/16"-18 x 1" Hex Cap Bolt
26	31000005052	5/16" SAE Washers
11	31180003352	5/16"-18 C-Lock Nuts
4	43141251081	7/16"-14 x 1-1/4" Hex Cap Bolt
1	43143751081	7/16"-14 x 3 3/4" Hex Cap Bolt
3	43143501081	7/16"-14 x 3-1/2" Hex Cap Bolt
16	43000005052	7/16" SAE Washers
8	43140004181	7/16"-14 C-Lock Nuts
6	50131251081	1/2"-13 x 1-1/4" Hex Cap Bolt
1	50133501081	1/2"-13 x 3-1/2" Hex Cap Bolt
6	50134001081	1/2"-13 x 4" Hex Cap Bolt
1	50136251081	1/2"-13 x 6-1/4" Hex Cap Bolt
22	50000005052	1/2" SAE Washers
11	50130004152	1/2"-13 C-LockNuts

FRONT SUSPENSION INSTRUCTIONS:

1. Disconnect the negative terminal on the battery. With the vehicle on level ground, set the emergency brake and block the rear tires. Jack up the front end of the truck and support the frame rails with jack stands. **NEVER WORK UNDER AN UNSUPPORTED VEHICLE!** Remove the front tires.

2. Remove and discard the factory splash guard under the differential.

3. Locate the sway bar end links and disconnect from the factory lower control arms, save the hardware. Locate the sway bar frame mounts and disconnect them from the frame, remove the sway bar from the truck. Save the hardware and sway bar.

4. Working from the driver side of the vehicle, disconnect the tie rod ends from the steering knuckle by striking the knuckle to dislodge the tie rod end. SEE FIGURE 1.



(Figure 1)

5. Remove factory Tie Rod end and discard. SEE FIGURE 2.



(Figure 2)

6. Remove the brake caliper and place it next to the frame. Do not overstretch the brake hose when doing so. Retain the hardware for reinstallation. Remove the brake rotor and save. Disconnect the vacuum lines attached to the rear of the hub assembly. Allow the vacuum lines to hang freely. Remove the electronic stability control (ESC) sensor from the top of the hub. Cover the sensor to keep it free from dirt and debris. SEE FIGURE 3.



(Figure 3) Brake Caliper Shown Hung from Frame

7. Carefully remove the dust cap covering the hub assembly nut. Remove the C.V. bearing nut and save the nut and dust cap. SEE FIGURE 4.

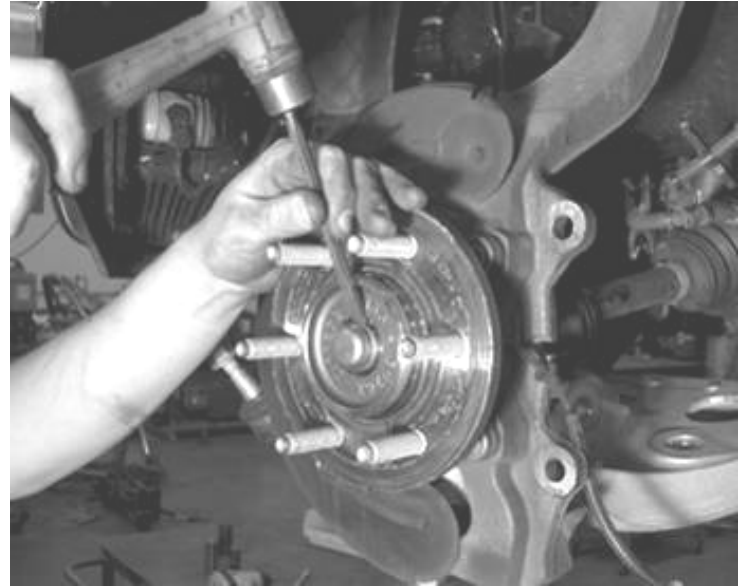

(Figure 4)

8. Remove the upper and lower ball joint nuts. Disconnect the upper and lower ball joints from the steering knuckle by striking the knuckle with a large hammer next to each ball joint on the knuckle to dislodge the ball joints. Use care not to hit the ball joints when removing. Retain hardware and remove the knuckle with the dust shield and the hub. **Use extra care not to over extend the C.V. axle shaft when removing the knuckle.** SEE FIGURE 5.



(Figure 5)

9. Remove the four large bolts and three small bolts on the back side of the knuckle. Remove the hub and the actuator from the knuckle. Save hardware for install in the Fabtech knuckle.

10. Remove the bolts on the front side holding the dust shield. Remove the dust shield and discard the factory knuckle.

11. Locate the lower shock mount bolt and remove. Save the hardware. Locate the three upper nuts and remove. Save the hardware. Remove the shock assembly from the vehicle and

mark "Driver" for assembly to install later with Fabtech shock extensions. SEE FIGURE 6.



(Figure 6)

12. Remove the lower control arm bolts from the frame pivots and remove the lower control arm from the truck. Save hardware and lower control arm. SEE FIGURE 7.



(Figure 7)

13. Repeat steps four through twelve on the passenger side of the truck.

14. Remove the factory rear crossmember from the vehicle and discard the crossmember and hardware. SEE FIGURE 8.



(Figure 8)

15. Remove the front drive shaft bolts where they attach to the front differential. Support the end of the drive shaft before removing the front differential.

16. Remove the driver side rear differential mount hardware and discard. While supporting the differential, remove the two upper differential mount bolts and remove the differential and axles from the vehicle. Save the hardware. SEE FIGURE 9.



(Figure 9)

17. Locate rear differential mount closest to the pinion shaft. Mark the mount behind the bushing. Using a die grinder remove the mount and discard. SEE FIGURES 10 and 11.



(Figure 10)

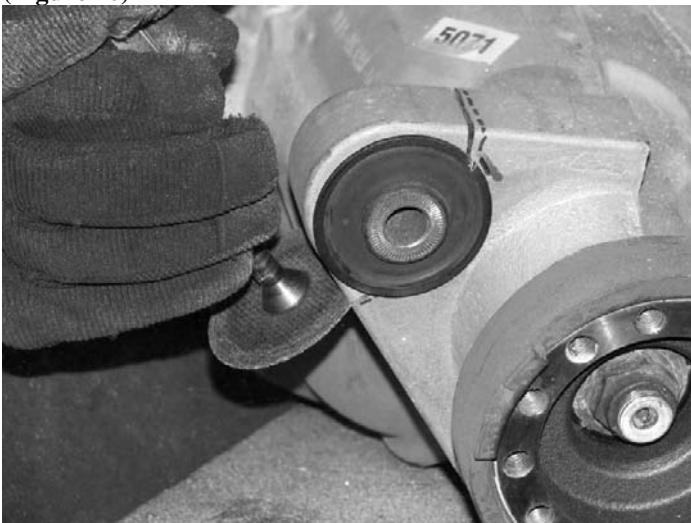

(Figure 11)

18. Use a sander and remove all sharp edges and burs after the cut. SEE FIGURE 12.



(Figure 12)

19. Locate the driver side rear lower control arm pocket. Mark the frame 1-3/8" from the control arm pivot hole and 90 degrees to the bottom of the pocket where the cross member was mounted. Using a die grinder, cut all the way around the pocket. Discard removed portion of the pocket. SEE FIGURES 15, 16 & 17.

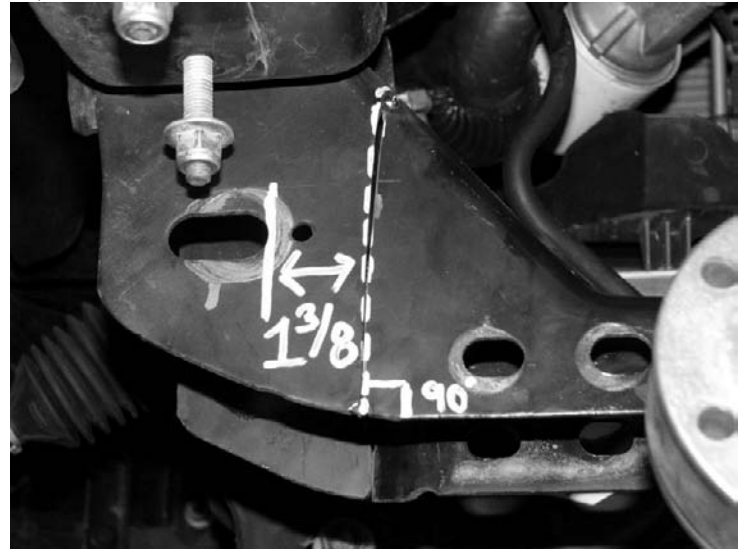

(Figure 15)

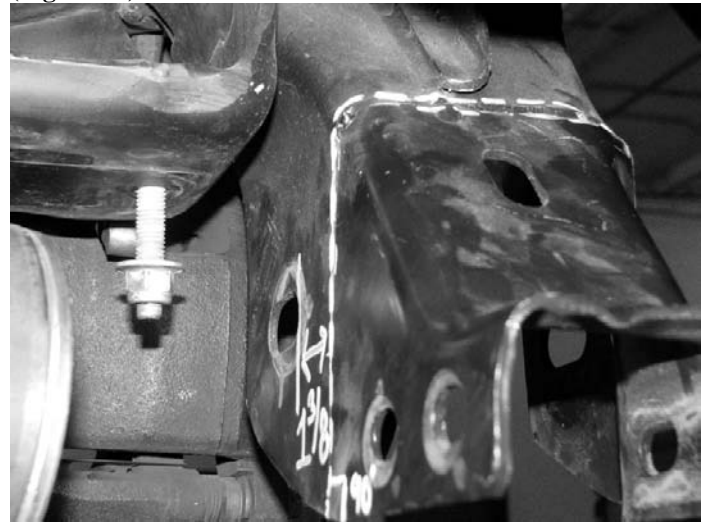

(Figure 16)

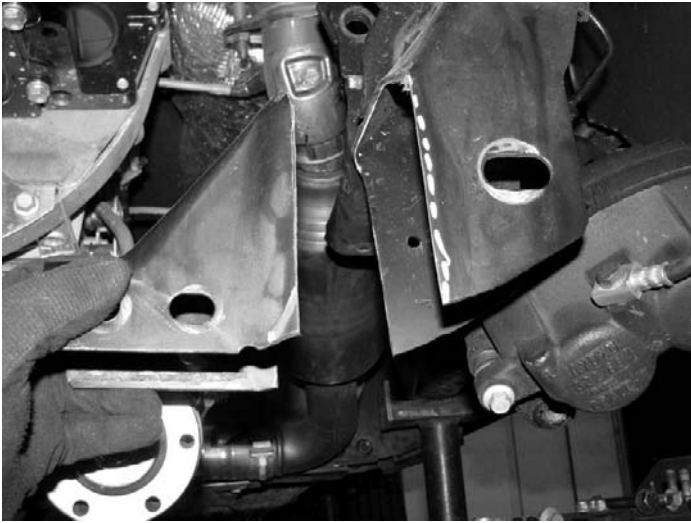

(Figure 17)

20. Still working on the driver side rear lower control arm pocket, locate the tab on the pocket closest to the front of the vehicle. You will need to sand a radius in the front side of the pocket in order to clear the differential housing. SEE FIGURE 18.

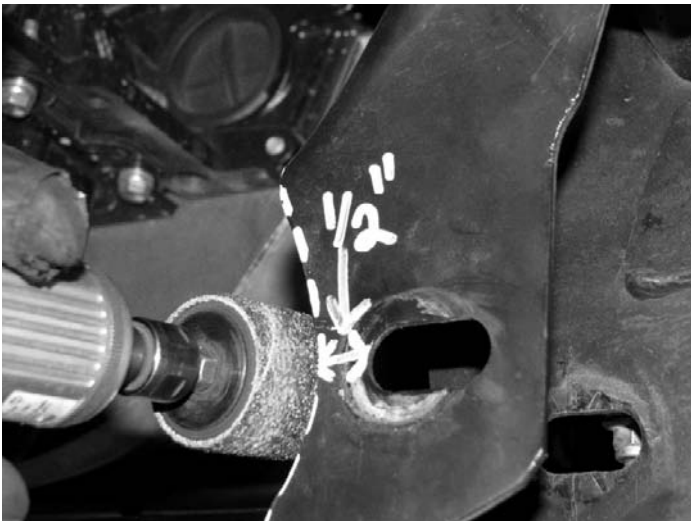

(Figure 18)

21. Locate the two Fabtech upper differential mounts (FT30378). These upper differential mounts will be placed into the factory upper differential mounts using the factory upper differential mount hardware. Leave the hardware loose in preparation for the differential installation. SEE FIGURES 19 & 20.



(Figure 19)

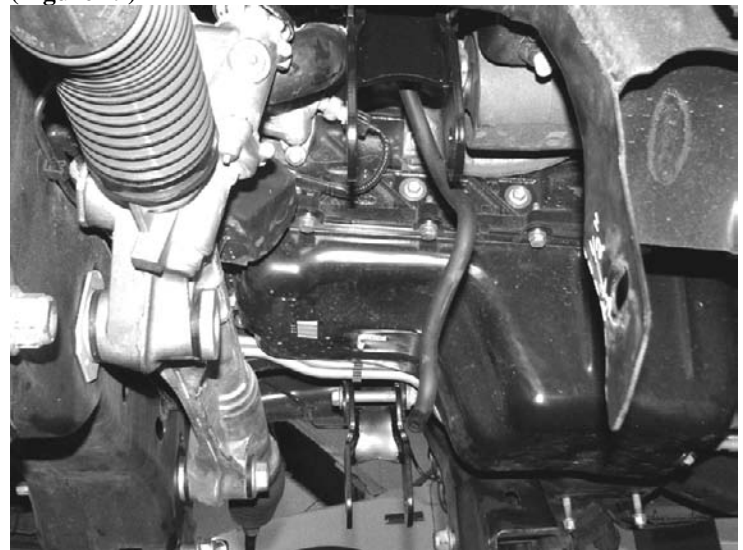

(Figure 20)

22. Locate the factory front differential and install into the Fabtech upper differential mounts using two 1/2''-13 x 4'' hex cap bolts, washers and lock nuts. Leave all hardware loose in preparation of the installation of the remaining differential mounts. SEE FIGURE 21.

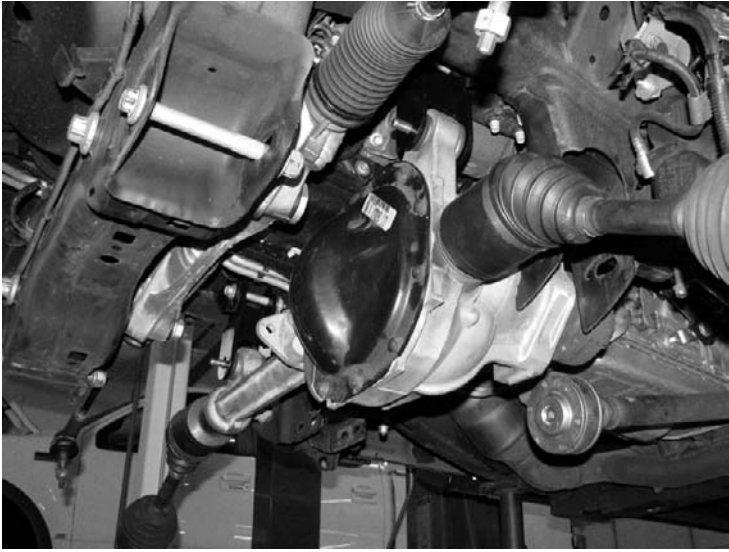

(Figure 21)

23. Locate the Fabtech rear crossmember (FT30376BK). Install the rear crossmember in the factory rear lower control arm pockets. Mount the crossmember using the factory control arm pivot hardware. Leave all hardware loose. All the tabs on the face of the crossmember should be pointed to the rear of the vehicle. SEE FIGURE 22.

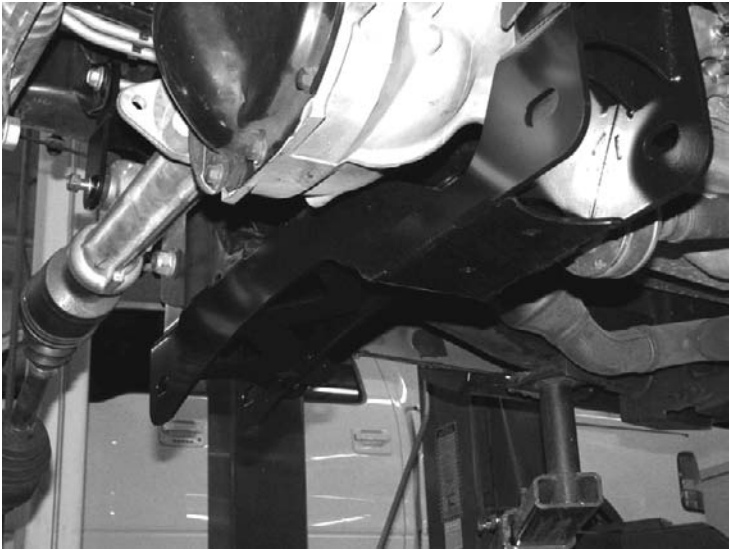

(Figure 22)

24. Remove the center differential housing bolts on the back side of the differential. SEE FIGURE 23.

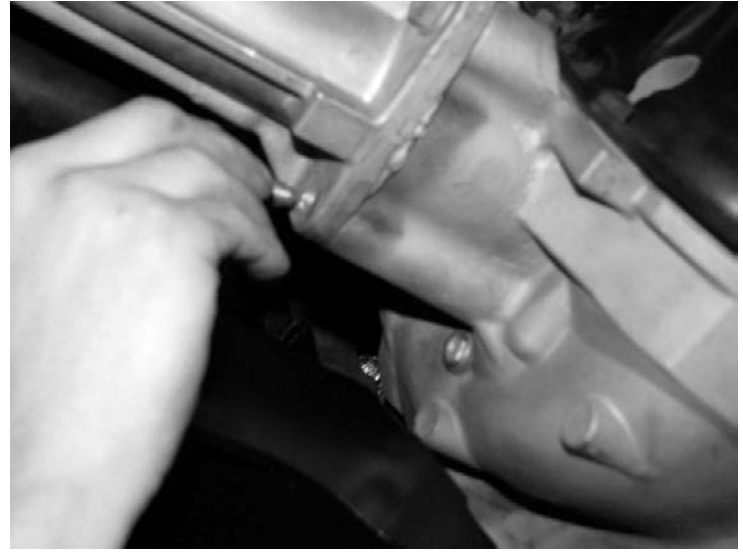

(Figure 23)

25. Locate the center differential bracket (FT30381). Install two of the Fabtech (FT1020) bushings and one sleeve (FT181) into the barrel on the differential bracket. Mount the differential bracket to the center of the differential and reinstall the factory bolts. Torque the factory hardware to 35 ft-lbs. The barrel and the bushing section of the bracket will install in to the two tabs on the top of the crossmember with a 1/2''-13 x 3-1/2'' bolt washers and c-lock nut. Leave loose. SEE FIGURE 24.

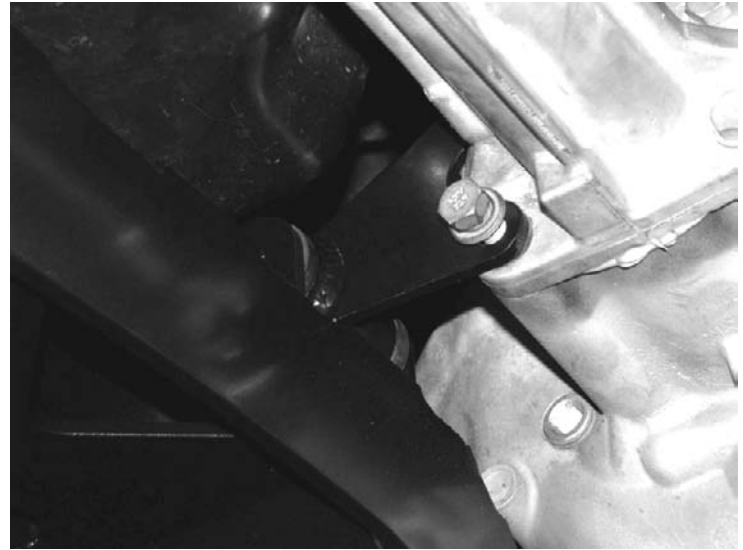

(Figure 24)

26. Reinstall the front drive shaft with the factory hardware and torque to 35 ft-lbs. SEE FIGURE 25.



(Figure 25)

27. Locate the Fabtech impact tubes (FT44017BK) Locate the Fabtech impact tube bushings (FT1044). Install the bushing into the barrels on the end of each impact tube. On one end of the driver side impact tube, you will need to drill out the bushings to $\frac{1}{2}$ ". **NOTE - ONLY ON THE DRIVER SIDE AND ONLY ON ONE END. SEE FIGURE 26**



(Figure 26)

28. Locate the end of the strut tube that has been drilled out to $\frac{1}{2}$ ". You will need to install this end into the tabs on the driver side of the crossmember next to the rear diff mount using $\frac{1}{2}$ "-13 x 6 1/2" bolt, washers and a C lock nut. This bolt will run through the impact tube bushing and the rear diff mount bushing. Leave loose.

29. Locate the rear diff mount (FT30422). Install two of the Fabtech (FT1020) bushings and one sleeve (FT181) into the barrel on the differential bracket. Install the diff mount into the rear crossmember tabs in line with the driver side impact tube. Leave all hardware loose. SEE FIGURE 27.

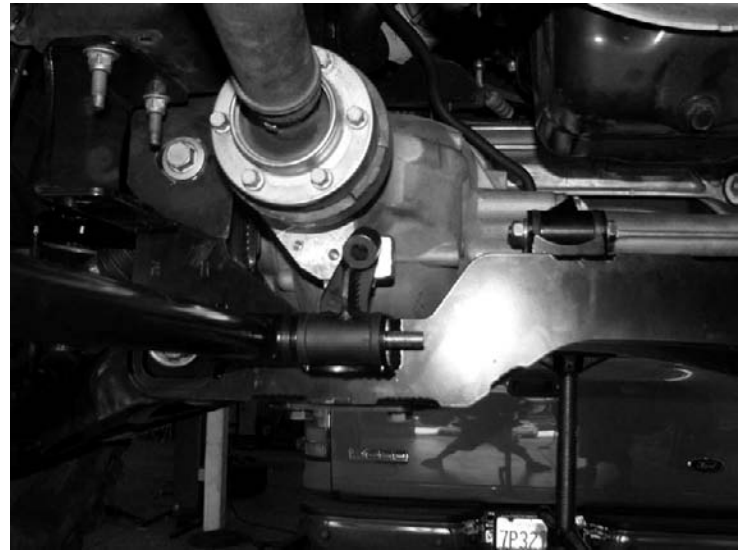

(Figure 27)

30. Rotate the rear diff mount up against the housing. Using the diff mount as a drill guide drill the housing to $\frac{7}{16}$ ". **NOTE – DEPENDING ON THE BUILD TIME OF THE VEHICLE THE HOUSING MAY HAVE A MACHIEND SURFACE AND A THREADED HOLE ON THE SECTION OF THE HOUSING YOU ARE WORKING WITH. THE (FT30422) REAR DIFF MOUNT WILL WORK WITH EITHER VERSION. SEE FIGURE 28**



(Figure 28)

31. Locate the supplied 7/16 - 14 x 3 3/4'' and install in to the Rear Diff Mount passing all the way through the diff housing. Torque to the specs. below
SEE FIGURE 28 & 29

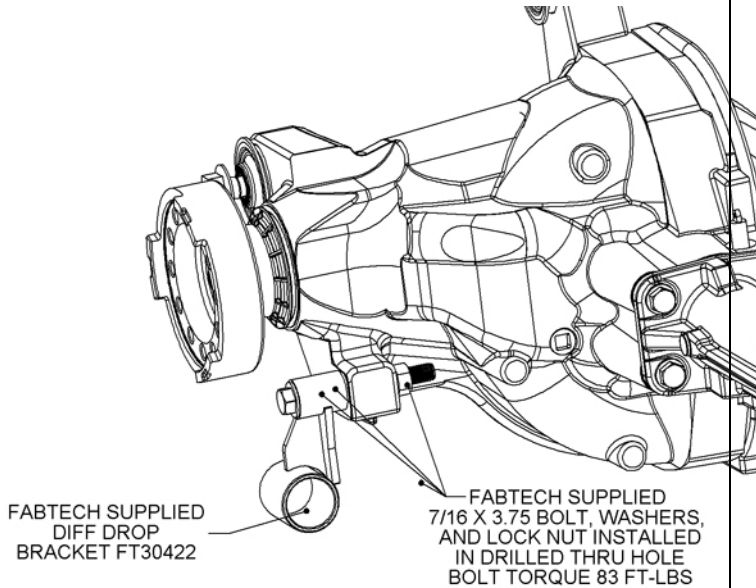

(Figure 28)



(Figure 29)

32. Locate the passenger side of the rear crossmeber and install the passenger impact tube into the tabs on the crossmeber using 7/16''-14 x 1-1/4'' bolt, washers and a c- lock nut.

33. Locate the factory transfer case crossmeber. You will need to cut a radius in the slots on the bottom of the crossmeber. The 1/2'' radius will be centered in the factory slot on the back side of the cross member. SEE FIGURES 30 & 31.



(Figure 30)



(Figure 31)

34. Locate the Fabtech impact tube mounts (FT30064BK) the two large washers (FT83159) and the nut tabs (FT90056). Locate the 1/2''-13 x 1-1/4'' bolt. Use this hardware to install this assembly. The impact tube bracket will mount on the bottom side of the crossmeber. The washer will go inside the crossmeber over the slot. The nut tab will mount on top of the washer inside the crossmeber holding the assembly together.

Leave the assembly loose until the impact tube is installed. SEE FIGURE 32.



(Figure 32)

35. Swing up the Fabtech impact tubes and install them into the impact tube bracket using the 7/16'' - 14 x 3-1/2'' bolts, washers and c-lock nuts. Torque the 1/2'' bolts holding the impact tube brackets to 127 ft-lbs. Torque the three 7/16'' bolts to 83 ft-lbs. SEE FIGURE 33.

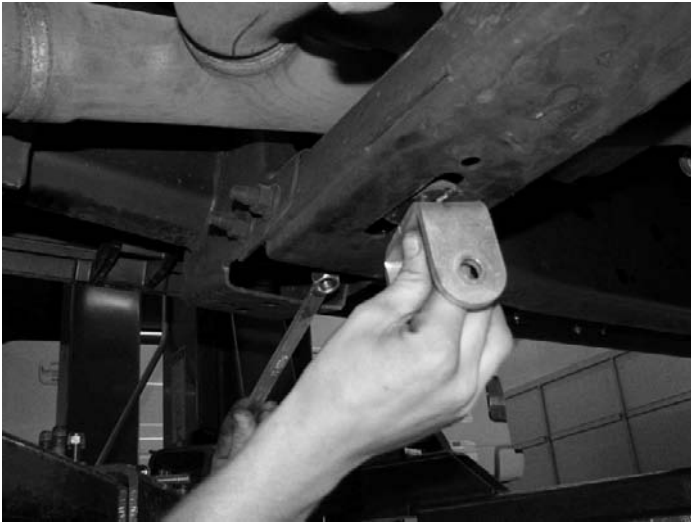

(Figure 33)

36. At this time locate all the differential brackets and torque to the specifications below.

- Upper diff bracket pass and driver - factory upper bolts 90 ft-lbs and lower 1/2'' bolts 127 ft-lbs.
- Center diff mount - 1/2'' bolt 127 ft-lbs.
- Rear diff mount and the impact tube - 1/2'' bolt 127 ft-lbs.

37. Reinstall the factory vent hose back on to the differential.

38. Locate the Fabtech front crossmember (FT30375BK). Install the front crossmember into the factory front control arm pockets using the factory hardware. Make sure the skid plate tab on the crossmember is facing the Fabtech rear crossmember. Leave the hardware loose at this time. SEE FIGURE 34.



(Figure 34)

39. Locate the Alignment cam kit (FT294). Locate the factory control arms. Install the lower control arms into the Fabtech crossmembers using the hardware in the cam kit (FT294). Torque the cam bolts at 200 ft-lbs after alignment. SEE FIGURE 35.

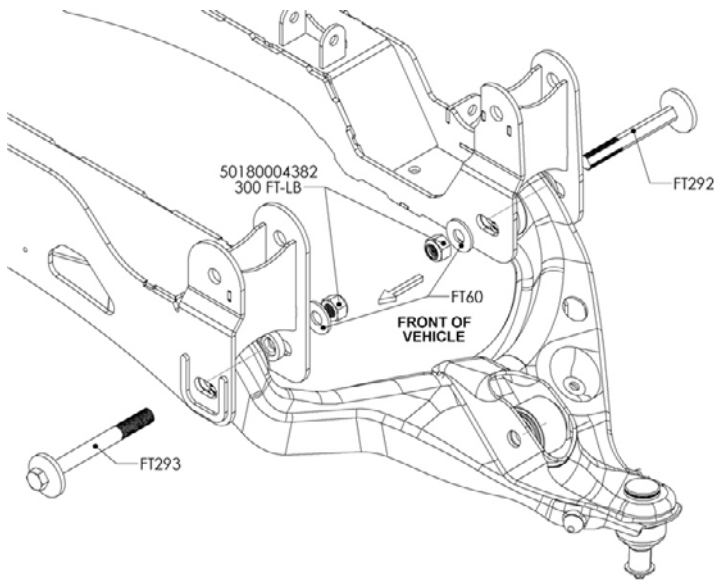

(Figure 35)

40. Locate the Fabtech skid plate (FT30377BK) the skid plate will span the distance between the front and rear crossmembers directly under the front differential. Attach the end of the skid plate with the single hole to the tab on the back side of the front crossmember using one 1/2'' - 13 x 1-1/4 bolt, washers and a C-lock nut. Lift up the back side of the skid plate and install it to the rear crossmember using two 1/2'' - 13 x 1-1/4 bolts, washers and a C-lock nut. Torque all hardware to 127 ft-lbs. SEE FIGURE 36.



(Figure 36)

41. Locate the Fabtech upper shock extensions (FT30382BK and FT30383BK), the lower shock extension (FT30384BK) and all hardware listed below. Locate the factory coil over shocks. Assemble the shock extension using FIGURE 37 and hardware listed below.

ITEM NO.	DESCRIPTION	Default/QTY.
1	SHOCK EXTENSION LOWER DRIVER	1
2	OEM COILOVER ASSEMBLY DRIVER	1
3	ALUMINUM SHOCK BUSHING	2
4	SHOCK EXTENSION UPPER	1
5	SHOCK EXTENSION UPPER	1
6	5/16"-18 X 1.25 HHCS	4
7	NUT 5/16-18 CRIMP LOCK G5 Z1	4
8	WASHER 5/16 SAE G5 Z1	8
9	F150 BUSHING HALF	2
10	SLEEVE 1.250 X .813 X 2.350	1
11	SCREW 1/2-13 X 4 HEX G8 Z2	2
12	NUT 1/2-13 CRIMP LOCK G5 Z1	2
13	WASHER 1/2 SAE G8 Z1	4

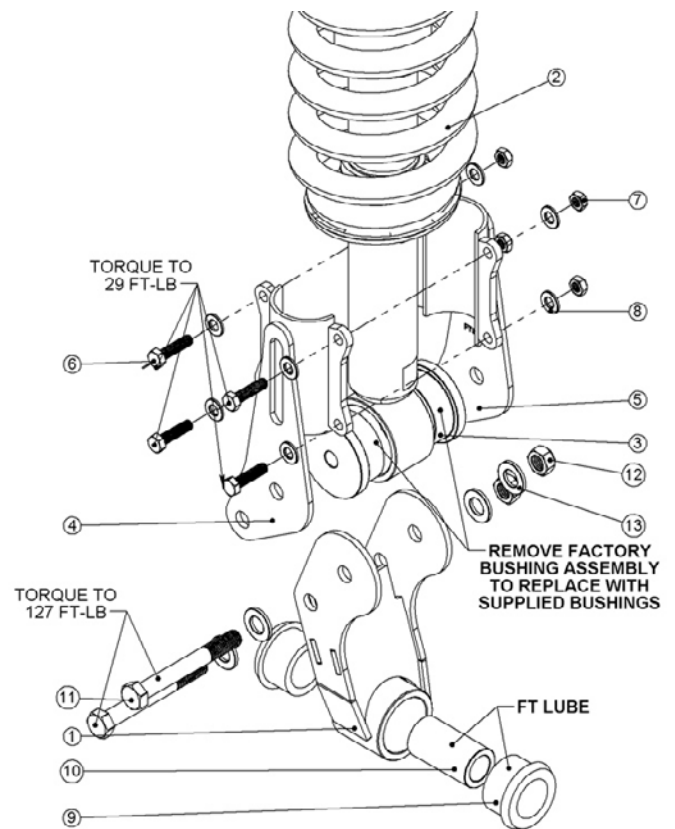

(Figure 37)

42. Locate the Fabtech driver side spindle (FTS30374D) and install the factory hub. Torque the four 14mm bolts to 160 ft-lbs. SEE FIGURES 38 & 39.



(Figure 38)



(Figure 39)

43. Locate the factory 4WD actuator and install into the Fabtech spindle. Torque the factory 8mm bolts to 17 ft-lbs. SEE FIGURE 40.

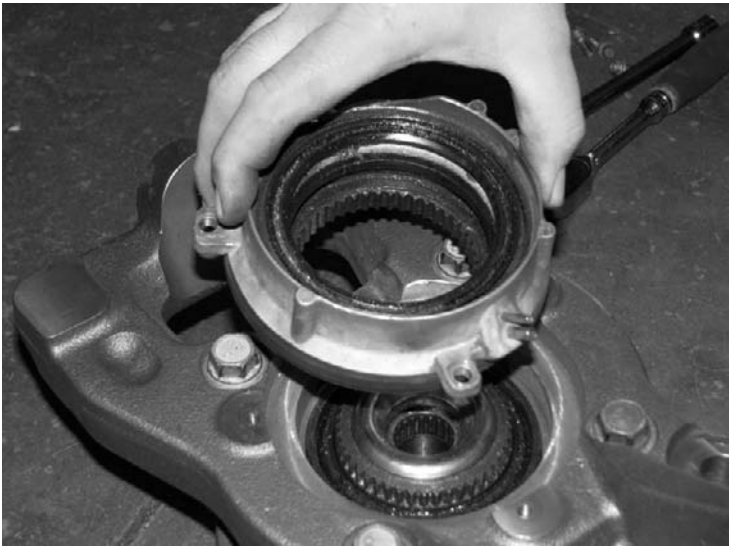

(Figure 40)

44. Install the Fabtech spindle onto the upper and lower control arms. Torque the upper ball joint to 85 ft-lbs and the lower ball joint to 110 ft-lbs. SEE FIGURE 41.



(Figure 41)

45. Install the dust shield and torque to 14 ft-lbs. Install CV shaft nut and torque to 35 ft-lbs. Install the factory dust cover. SEE FIGURE 42.



(Figure 42)

46. Install the ABS wheel speed sensor. Make sure the end of the sensor is clean. SEE FIGURE 43.



(Figure 43)

47. Carefully pull some slack from the frame side and reconnect the vacuum line to the hub assembly. Install the Fabtech frame brake line bracket (FT70032). Using the factory hardware, mount factory brake line bracket to the side of the Fabtech knuckle. After installing the factory brake line bracket, check to insure full movement by steering the knuckle back and forth, and make sure none of the ABS lines, brake lines, or vacuum lines are inhibited during full test movement of the knuckle. SEE FIGURES 44A and 44B.

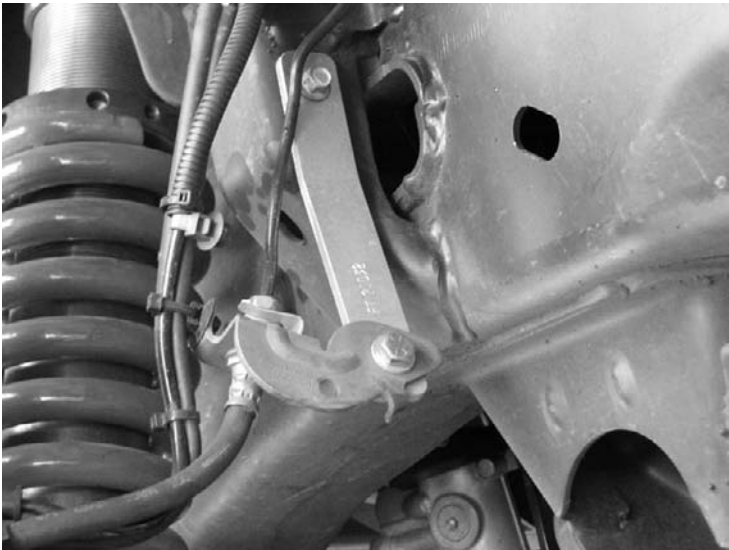

(Figure 44A)

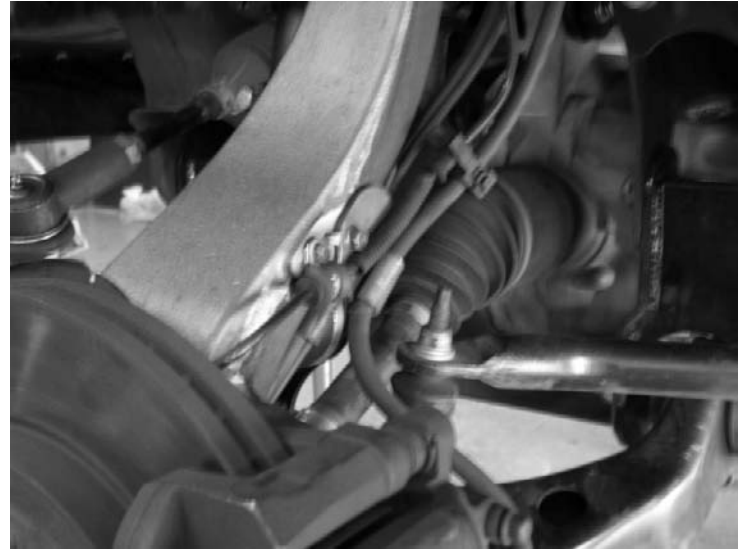

(Figure 44B)

48. Reinstall the original brake rotor, followed by the brake caliper. Use a small amount of the supplied thread lock compound on the caliper bolts and torque to 145 ft-lbs. SEE FIGURE 45.

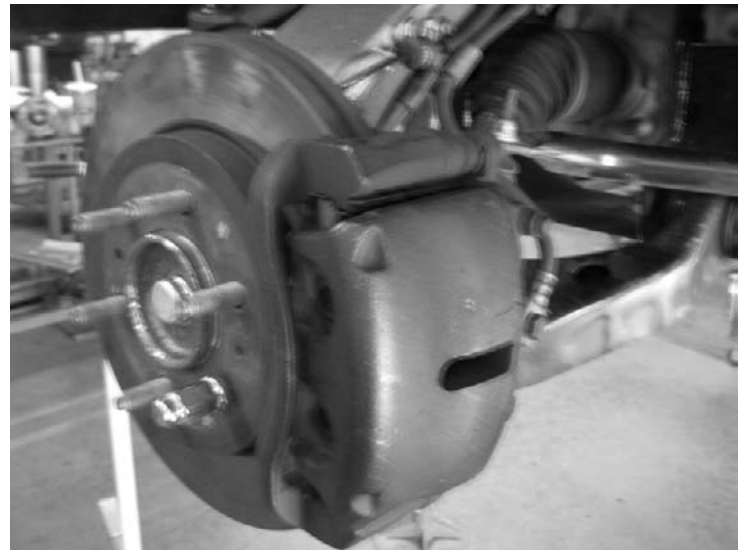

(Figure 45)

49. Locate the factory tie rod. Trim 1" off the end. SEE FIGURES 46 & 47.



(Figure 46)

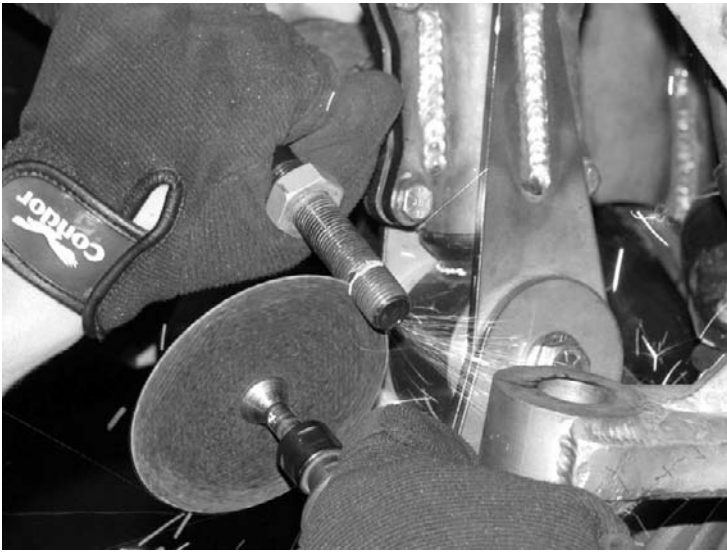

(Figure 47)

50. Locate the Fabtech tie rod end (FT20277). Install the tie rod end on the tie rod. SEE FIGURE 48.



(Figure 48)

51. Reconnect the tie rod end to the steering knuckle and torque to 110 ft.-lbs

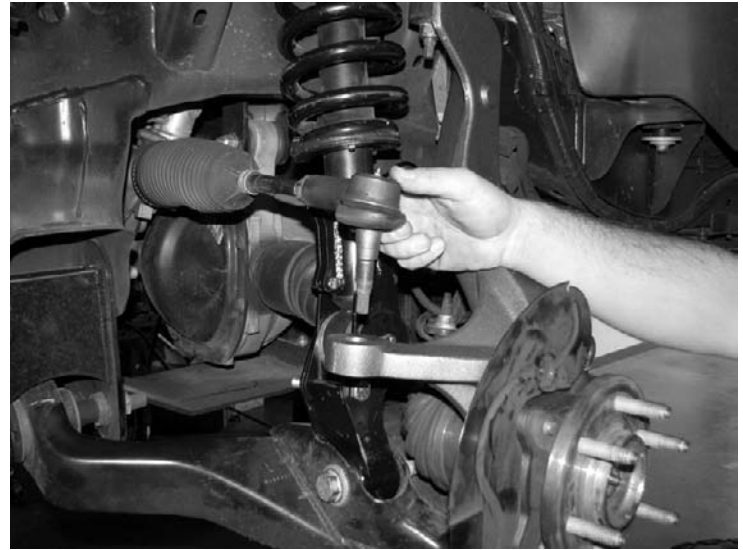

(Figure 49)

52. Install the factory sway bar using the Fabtech driver and pass brackets (FT30062BK) (FT30063BK).

REAR SUSPENSION INSTRUCTIONS:

53. Jack up the rear end of the vehicle and support the frame rails with jack stands. Release the parking brake at this time. Supporting the rear differential, remove the rear shocks, u-bolts, blocks and lower axle down. Use care not to over extend the brake hose.

54. Locate the factory brake line mount on the driver side of the frame. Locate the supplied brake line bracket (FT70033) and attach the bracket between the factory frame mount and the factory brake line. SEE FIGURE 50



(Figure 50)

55. Locate and install the rear lift blocks FTBK52. The extended bump stop perch will be facing inboard of the truck. Using the provided u-bolts, nuts and washers, align the axle, lift blocks, and springs and torque u-bolts to 90 ft-lbs. SEE FIGURE 51.



(Figure 51)

56. Locate FTS7266 rear shocks (not included with kit). Install the supplied shock sleeves from bag 143002 into each end of the shocks. Install the shocks using the factory hardware and torque upper and lower bolts to 45 ft-lbs.

57. Locate E-brake bracket (FT30387) and mount to the factory E-brake cable mount and reinstall the E-brake cable into the Fabtech bracket. SEE FIGURE 52.

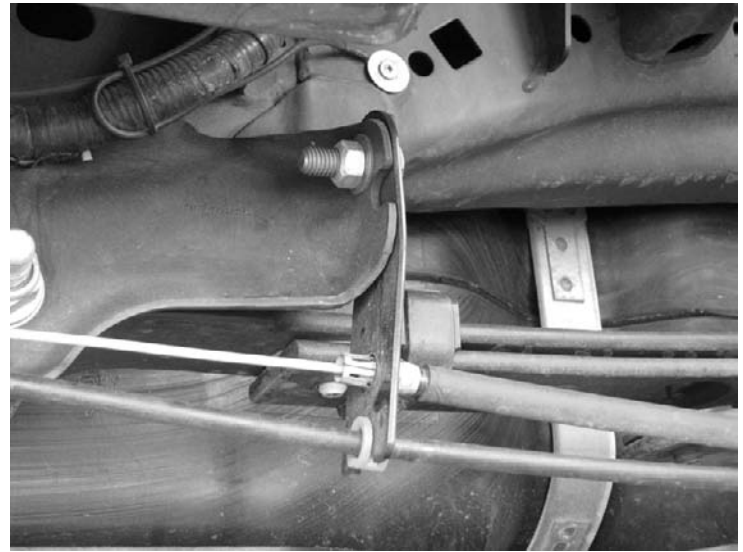

(Figure 52)

58. Recheck all bolts for proper torque. Recheck the front and rear brake hoses and ABS lines for proper clearances.

59. Install tires and wheels and torque lug nuts to wheel manufacturer's specifications. Turn front tires left to right and check for appropriate tire clearance. Note -Some oversized tires may require trimming of the bumper and valance.

60. Check the front-end alignment and set to the factory specifications. Re-adjust vehicles headlights.

RETORQUE ALL NUTS, BOLTS AND LUGS AFTER 50 MILES AND PERIODICALLY THEREAFTER.

For technical assistance call: 909-597-7800

Product Warranty and Warnings-

Fabtech provides a Limited Lifetime Warranty to the original retail purchaser who owns the vehicle, on which the product was originally installed, for defects in workmanship and materials.

The Limited Lifetime Warranty excludes the following Fabtech items; bushings, bump stops, ball joints, tie rod ends, limiting straps, cross shafts, heim joints. These parts are subject to wear and are not considered defective when worn. They are warranted for 60 days from the date of purchase for defects in workmanship.

Take apart shocks are considered a serviceable shock with a one year warranty on leakage only. Service seal kits are available separately for future maintenance. All other shocks are covered under our Limited Lifetime Warranty.

Fabtech does not warrant any product for finish, alterations, modifications and/or installation contrary to Fabtech's instructions. Alterations to the finish of the parts including but not limited to painting, powdercoating, plating and/or welding will void all warranties. Some finish damage may occur to parts during shipping which is considered normal and is not covered under warranty.

Fabtech products are not designed nor intended to be installed on vehicles used in race applications or for racing purposes or for similar activities. (A "RACE" is defined as any contest between two or more vehicles, or any contest of one or more vehicle against the clock, whether or not such contest is for a prize). This warranty does not include coverage for police or taxi vehicles, race vehicles, or vehicles used for government or commercial purposes. Also excluded from this warranty are sales outside of the United States of America.

Installation of most suspension products will raise the center of gravity of the vehicle and will cause the vehicle to handle differently than stock. It may increase the vehicle's susceptibility to a rollover, on road and off road, at all speeds. Extreme care should be taken to operate the vehicle safely at all times to prevent rollover or loss of control resulting in serious injury or death. Fabtech front end Desert Guards may impair the deployment or operation of vehicles equipped with supplemental restraining systems/air bag systems and should not be installed if the vehicle is equipped as so.

Fabtech makes every effort to ensure suspension product compatibility with all vehicles listed in the catalog, but due to unknown auto manufacturer's production changes and/or inconsistencies by the auto manufacturer, Fabtech cannot be responsible for 100% compatibility, including the fitment of tire and wheel sizes listed. The Tire and Wheel sizes listed in Fabtech's catalog are only a guideline for street driving with noted fender trimming. Fabtech is not responsible for damages to the vehicle's body or tires.

Fabtech's obligation under this warranty is limited to the repair or replacement, at Fabtech option, of the defective product only. All costs of removal, installation or re-installation, freight charges, incidental or consequential damages are expressly excluded from this warranty. Fabtech is not responsible for damages and/or warranty of other vehicle parts related or non related to the installed Fabtech product. This warranty is expressly in lieu of all other warranties expressed or implied. This warranty shall not apply to any product that has been subject to accident, negligence, alteration, abuse or misuse as determined by Fabtech.

Fabtech suspension components must be installed as a complete system including shocks as shown in our current catalog. All warranties will become void if Fabtech parts are combined and/or substituted with other aftermarket suspension products. Combination and/or substitution of other aftermarket suspension parts may cause premature wear and/or product failure resulting in an accident causing injury or death. Fabtech does not warrant products not manufactured by Fabtech.

Installation of Fabtech product may void the vehicles factory warranty; it is the consumer's responsibility to check with their local vehicle's dealer for warranty disposition before the installation of the product.

It is the responsibility of the distributor and/or the retailer to review all warranties and warnings of Fabtech products with the consumer prior to purchase.

Fabtech reserves the right to supercede, discontinue, change the design, finish, part number and, or application of parts when deemed necessary without written notice. Fabtech is not responsible for misprints or typographical errors within the catalog or price sheet.