



## **INSTALLATION INSTRUCTIONS**



### **2006-12 TOYOTA FJ 2WD/4WD 6" BASIC & PERFORMANCE SYSTEMS**

**FTS26016BK / FTS26017BK / FTS26018BK / FTS26032 / FTS26033**

**Fabtech Motorsports** | 4331 Eucalyptus Ave. Chino, CA 91710

**Tech Line:** 909-597-7800 | **Fax:** 909-597-7185 | **Web:** [www.fabtechmotorsports.com](http://www.fabtechmotorsports.com)



**- PARTS LIST -**

**2006-09 TOYOTA FJ 2WD/4WD**

**FTS26016BK / FTS26017BK / FTS26010BK / FTS26018BK**

	<b>FTS26016BK</b>	<b>COMPONENT BOX 1</b>
1	FTS70234D	Spindle (Driver)
1	FTS70234P	Spindle (Passenger)
2	FT70099	Tie Rod End
2	FT70059BK	Impact Strut Mount
2	FT70066BK	Impact Strut
1	FT70100BK	Sway Bar Drop (Driver)
1	FT70101BK	Sway Bar Drop (Passenger)
2	FT70094	Body Mount Weld In Plate
1	FT70069	Hardware Kit
2	FTS88	Bump Stops
1	FT70167	Hardware Subassembly

	<b>FTS26017BK</b>	<b>COMPONENT BOX 2</b>
1	FT70082BK	Front Crossmember
1	FT70083BK	Rear Crossmember
2	FT70098	Crossmember Weld in Plate
1	FT70058BK	Skid Plate
1	FT70053	Lower Diff Bracket (Driver)
1	FT70054	Lower Diff Bracket (Passenger)
1	FT70056BK	Bump Stop Mount (Driver)
1	FT70057BK	Bump Stop Mount (Passenger)

	<b>FTS26010BK</b>	<b>COIL SPACER KIT</b>
2	FT70055BK	Coil Spacer

	<b>FTS26018BK</b>	<b>REAR BOX KIT</b>
2	FT70084BK	Upper Link Arm D/P
2	FT70085BK	Lower Link Arm D/P
1	FT70086BK	Coil Spacer (Driver)
1	FT70086BK	Coil Spacer (Passenger)
1	FT70088BK	Trac Bar Bracket
1	FT70096	Trac Bar Bracket Nut Tab
1	FT70089	Brake Line Bracket
2	FT70090BK	Sway Bar End Link
2	FT70093BK	Rear Bump Stop Bracket
1	FT50116	Sway Bar Bushing Kit
1	FT50089	Sway Bar Sleeve Kit
1	FT70091	Front & Rear Hardware Kit
2	FT83239	Rear Shock Spacer
1	FT70092	Rear Bushing Kit
2	103600007	Rear Shock Bushing

**- TOOL LIST -**

**Required Tools (Not Included)**

- Floor Jack
- Jack Stands
- Assorted Metric and S.A.E sockets
- Drill and Drill Bits
- Welder
- Torque Wrench
- Sawzall or Die Grinder
- Press
- Coil Spring Compressor



**- PARTS LIST -**

**2010-12 TOYOTA FJ 2WD/4WD**

**FTS26032 / FTS26033 / FTS26010BK / FTS26018BK**

	<b>FTS26032</b>	<b>COMPONENT BOX 1</b>
2	FT70059BK	Impact Strut Mount
2	FT70066BK	Impact Strut
1	FT70069	Hardware Kit
2	FT70094	Body Mount Weld In Plate
2	FT70123	Tie Rod End
1	FT70164BK	Sway Bar Drop (Driver)
1	FT70165BK	Sway Bar Drop (Passenger)
1	FTS70234D	Spindle (Driver)
1	FTS70234P	Spindle (Passenger)
1	FT70167	Hardware Subassembly

	<b>FTS26033</b>	<b>COMPONENT BOX 2</b>
2	FT13	Pop Rivet Aluminum
1	FT70053	Lower Diff Bracket (Driver)
1	FT70054	Lower Diff Bracket (Passenger)
1	FT70056BK	Bump Stop Mount (Driver)
1	FT70057BK	Bump Stop Mount (Passenger)
1	FT70058BK	Diff Skid Plate
1	FT70162BK	Front Crossmember
1	FT70163BK	Rear Crossmember
2	FT70098	Crossmember Weld In Plate

	<b>FTS26010BK</b>	<b>COIL SPACER KIT</b>
2	FT70055BK	Coil Spacer

	<b>FTS26018BK</b>	<b>REAR BOX KIT</b>
2	FT70084BK	Upper Link Arm D/P
2	FT70085BK	Lower Link Arm D/P
1	FT70086BK	Coil Spacer (Driver)
1	FT70086BK	Coil Spacer (Passenger)
1	FT70088BK	Trac Bar Bracket
1	FT70096	Trac Bar Bracket Nut Tab
1	FT70089	Brake Line Bracket
2	FT70090BK	Sway Bar End Link
2	FT70093BK	Rear Bump Stop Bracket
1	FT50116	Sway Bar Bushing Kit
1	FT50089	Sway Bar Sleeve Kit
1	FT70091	Front & Rear Hardware Kit
2	FT83239	Rear Shock Spacer
1	FT70092	Rear Bushing Kit
2	103600007	Rear Shock Bushing

## 2006-12 TOYOTA FJ 2WD/4WD

### FT70069 / FT70091 / FT70167

	<b>FT70069</b>	<b>HARDWARE KIT</b>
2	3/4"-10 x 4 1/2" Bolt	Front Crossmember
2	3/4"-10 C-Lock	
4	3/4" SAE Flat Washer	
2	9/16"-12 x 5" Bolt	Rear Crossmember
2	9/16"-12 C-Lock	
4	9/16" SAE Flat Washer	
2	5/16"-18 x 1 1/4" Bolt	Diff Skid Plate
2	5/16"-18 C-Lock	
4	5/16" SAE Flat Washer	
1	1/2"-13 1 1/2" Bolt	
1	1/2"-13 C-Lock	
2	1/2" SAE Flat Washer	
2	1/2"-13 x 4" Bolt	Diff Mounts
2	1/2"-13 C-Lock	
4	1/2" SAE Flat Washer	
4	3/8"-16 x 1 1/4" Bolt	Bump Stop Bracket
4	3/8"-16 C-Lock	
8	3/8" SAE Flat Washer	
2	10mmx1.25 x 25mm Bolt	
2	10mm Flat Washer	
2	3/8"-16 Nyloc	Bump Stop
2	3/8" SAE Flat Washer	
4	3/8"-16 x 1 1/4" Bolt	Sway Bar & Bracket
4	3/8"-16 C-Lock	
8	3/8" SAE Flat Washer	
6	3/8"-16 C-Lock	Coil Spacers
6	3/8" SAE Flat Washers	
8	1/8" Cotter Pin	
2	Thread Locking Compound	

	<b>FT70167</b>	<b>HARDWARE SUBASSEMBLY</b>
2	50133501081	1/2"-13 X 3 1/2" Hex Bolt
1	FT1044	Bushing Kit
1	FT90087	Bushing Kit
2	FT133	Sleeve, Impact Strut Brkt
2	FT26016i	Instruction Sheet
2	FT70061	Front Brake Line Bracket
1	FT70063	Spindle Brake Line Bracket (Driver)
1	FT70064	Spindle Brake Line Bracket (Passenger)
2	FT70102	Sway Bar Hat
2	FT70106	Sway Bar Drop Nut Tab
2	FT70105	Sway Bar End Link
6	FT70159	Mis-Alignment
4	FT95023	1/2" Heim
2	FTS88	Bumpstop

	<b>FT70091</b>	<b>HARDWARE KIT</b>
4	7/16"-14 x3 1/2" Bolt	Impact Tube
4	7/16"-16 C-Lock	
8	7/16" SAE Flat Washer	
2	1/2"-13 x 3" Hex Bolt	Impact Tube Bracket
2	1/2"-13 C-Lock	
4	1/2" SAE Flat Washer	
2	5/16"-18 x 1" Bolt	Front Brake Line Drop
2	5/16"-18 C-Lock	
4	5/16" SAE Flat Washer	
12	1/4"-20 x 3/4" Bolt	ABS & Brake Line Clamps
12	1/4" Split Washer	
12	1/4" SAE Washer	
2	3/8"-16 x 1 1/4" Bolt	Front Sway Bar Bracket
2	3/8" SAE Flat Washer	
2	3/8" Split Washer	
2	3/8"-16 x 2 1/4" Bolt	Sway Bar End Link (Bottom)
2	3/8"-16 x 3" Bolt	Sway Bar End Link (Top)
4	3/8"-16 C-Lock Nut	
6	3/8" SAE Flat Washer	
4	1/2"-20 Jam Nut	
6	3/8"-16 x 1 1/4" Bolt	Coil Spacers
6	3/8"-16 C-Lock Nut	
12	3/8" SAE Flat Washer	
4	8mm x 1.25x30 mm Bolt	
4	8mm Split Washer	
4	8mm Flat Washer	
4	5/16"-18 x 1" Bolt	Bumpstops
4	5/16"-18 C-Lock Nut	
8	5/16" SAE Flat Washer	
1	9/16"-12 x 3 1/2" Bolt	Trac Bar Bracket
1	9/16"-12 C-Lock Nut	
2	9/16" SAE Flat Washer	
1	1/2"-13 x 1 1/2" Bolt	
1	1/2" Split Washer	
1	1/2" SAE Flat Washer	
3	5/16"-18 x 3/4" Bolt	Brake & E-Brake Cable Brkt
3	5/16"-18 C-Lock Nut	
6	5/16" SAE Flat Washer	
2	12mm x 1.75x70mm Bolt	Sway Bar End Link
2	12mm x 1.75 C-Lock Nut	
6	1/2" USS Flat Washer	
2	3/8"-24 C-lock Nut	
7	Adel Clamp (FTCLAMP)	ABS Lines



## **- PRE-INSTALLATION NOTES -**

### ***Read this before you begin installation-***

Check all parts to the parts list above before beginning installation. If any parts are missing contact Fabtech at 909-597-7800 and a replacement part will be sent to you immediately.

Read all instructions thoroughly from start to finish before beginning the installation. If these instructions are not properly followed severe frame, driveline and / or suspension damage may occur.

Check your local city and state laws prior to the installation of this system for legality. Do not install if not legal in your area.

Prior to the installation of this suspension system perform a front end alignment and record. Do not install this system if the vehicle alignment is not within factory specifications. Check for frame and suspension damage prior to installation.

The installation of this suspension system should be performed by two professional mechanics.

Use the provided thread locking compound on all hardware.

Do not combine this suspension system with any other lift device or parts.

This suspension must be installed with Fabtech shock absorbers.

**WARNING-** Installation of this system will alter the center of gravity of the vehicle and may increase roll over as compared to stock.

For technical assistance call: 909-597-7800 or e-mail: [info@fabtechmotorsports.com](mailto:info@fabtechmotorsports.com)

Kit does not fit models with factory electronic controlled shocks.

If installing the optional Dirt Logic coilover, record the ride height of the vehicle so that the proper ride height can be done when completed.

Welding Required

Verify differential fluid is at manufactures recommended level prior to kit installation. Installation of the kit will reposition the differential and the fill plug hole may be in a different position. (For example, if the manufacture recommends 3 quarts of fluid, make sure the diff has 3 quarts of fluid). Check your specific manual for correct amount of fluid.

### ***Recommend Tires and Wheels:***

Use 35/12.50R17 tire w/ 17x8 wheels w/ 4-5/8" BS w/ minor trimming

Use 35/12.50R18 tire w/ 18x9 wheels w/ 4-1/2" BS w/ minor trimming

Use 35/12.50R20 tire w/ 20x9 wheels w/ 4 1/2" BS w/ minor trimming

# - INSTRUCTIONS -

## FRONT SUSPENSION

1. Disconnect the negative terminal on the battery. Jack up the front end of the truck and support the frame rails with jack stands. **NEVER WORK UNDER AN UNSUPPORTED VEHICLE!** Remove the front tires.
2. Working from both sides of the truck, locate and remove the factory skid plate and brackets. Discard skid plate and hardware, these will not be reinstalled on the truck. **SEE FIGURE 1**



FIGURE 1

3. Remove factory mud flaps off front of the vehicle and discard.
4. Remove the nut from the tie rod ends. Disconnect the tie rod ends from the steering knuckle by striking the knuckle with a large hammer to dislodge the tie rod end. Use care as to not hit the threads on the tie rod end with the hammer as you will damage them. Save all hardware. **SEE FIGURE 2**

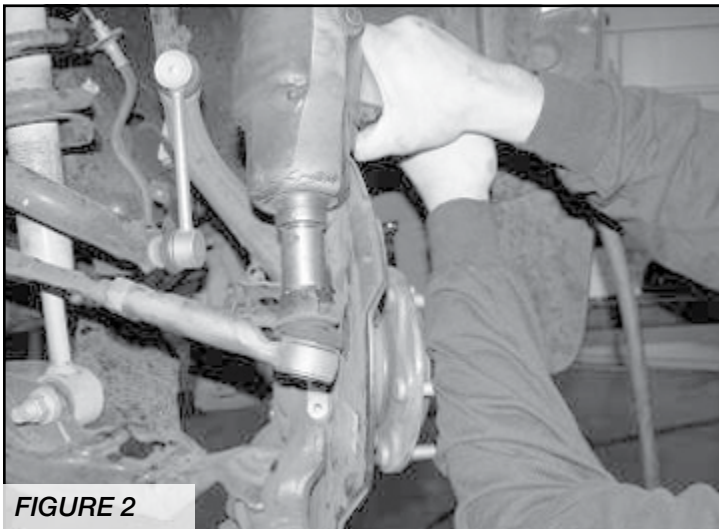


FIGURE 2

5. Remove the sway bar end links from the factory steering knuckles and leave connected to the bar. Then remove the bar from the truck. Save the bar and end links with all hardware. **SEE FIGURES 3-4**

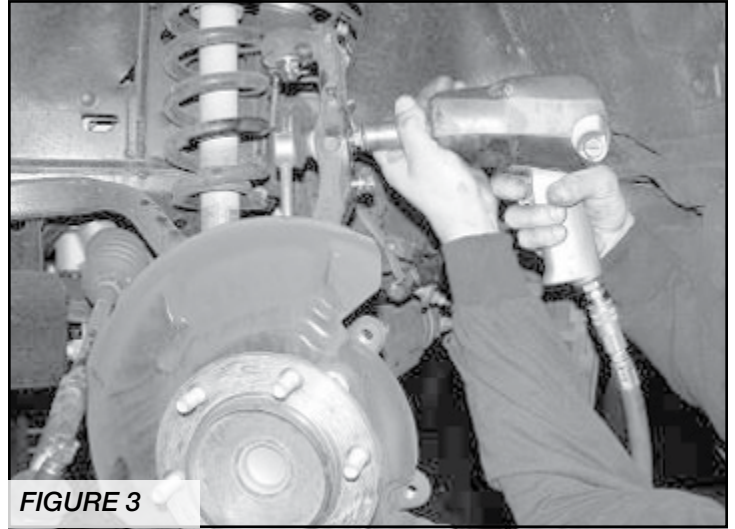


FIGURE 3

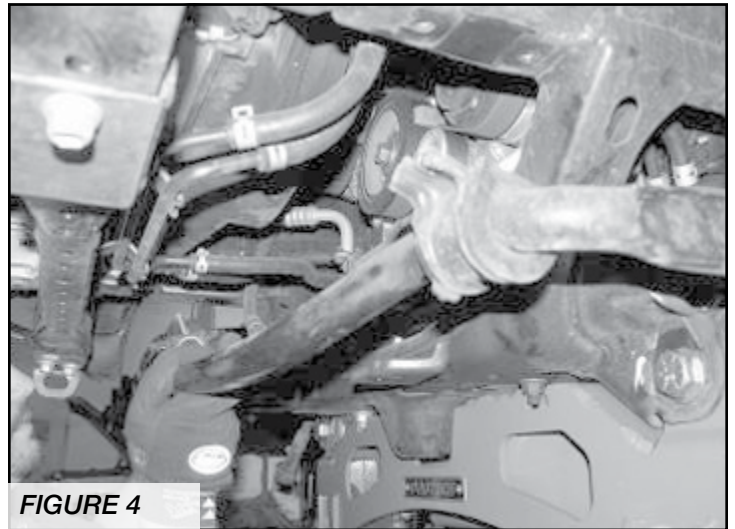


FIGURE 4

6. Remove the brake caliper from the steering knuckle and hang out of the way. Do not allow the brake caliper to hang from brake line. Remove the brake line brackets from the knuckle. Trucks equipped with ABS brakes, unbolt the ABS line and disconnect from steering knuckle and the upper control arm. Remove the bracket from the ABS line and discard. **SEE FIGURE 5**

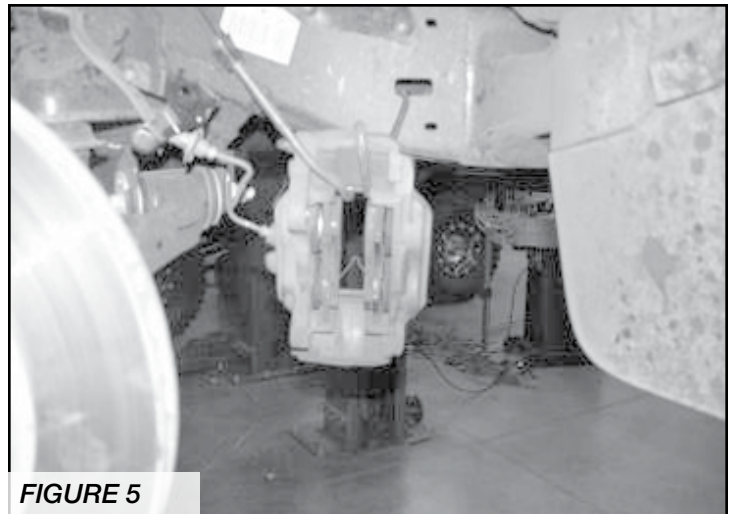
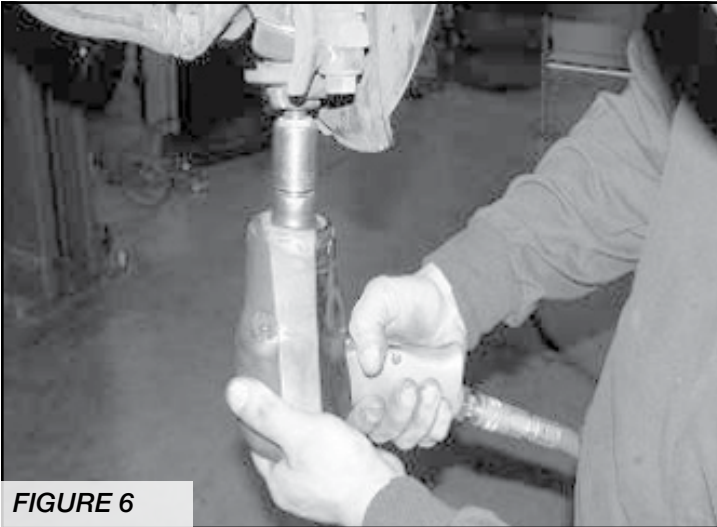


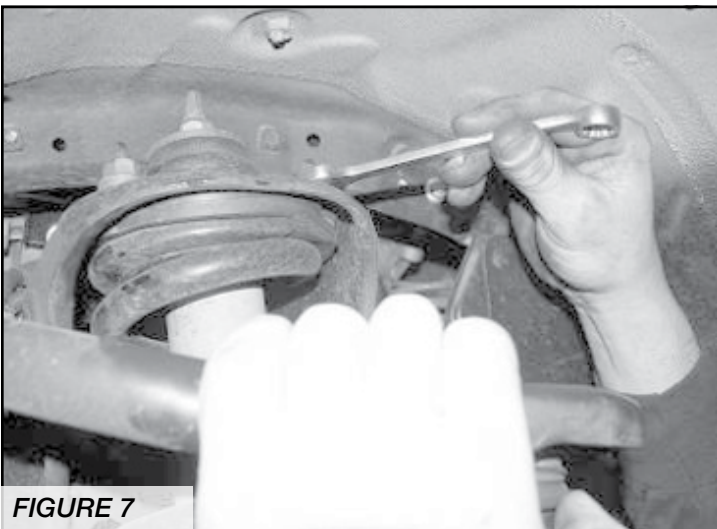
FIGURE 5

7. Remove the brake rotor, save all hardware.
8. Support the lower A-Arm with a floor jack. Loosen the upper ball joint nut. Disconnect the upper ball joint from the upper control arm by striking the knuckle with a large hammer next to the ball joint to dislodge the ball joint. Use care not to hit the ball joint when removing.
9. Remove the castle nut and two bolts on each side connecting the lower ball joint assembly to the knuckle. Save the Castle nut, as you will reuse it. Remove spindle assembly from truck. Remove the lower section of the spindle still attached to the control arm by striking with a large hammer. Use care not to hit the ball joint.  
**SEE FIGURE 6**

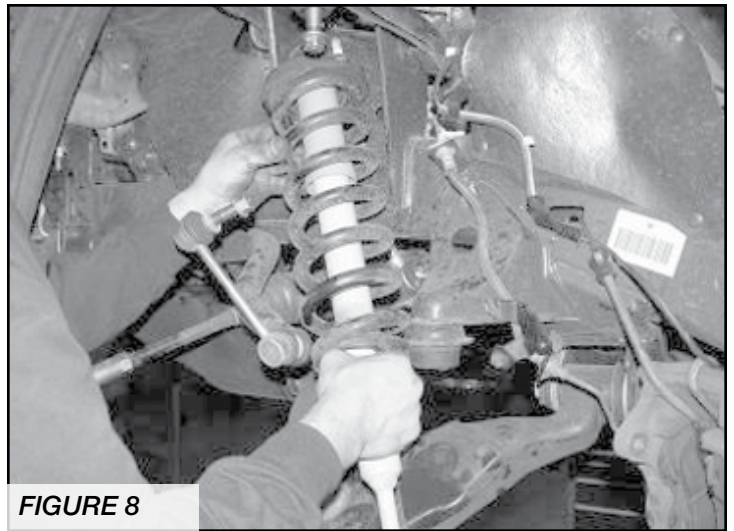


**FIGURE 6**

10. Remove the three upper nuts from the top of the strut assembly then the lower bolt from the strut at the lower control arm. Remove the shock assembly as one complete unit and save with the hardware if installing the Basic Kit (coil spacer) retain shock assembly, if installing Dirt Logic coilovers discard shock assembly.  
**SEE FIGURES 7-8**



**FIGURE 7**

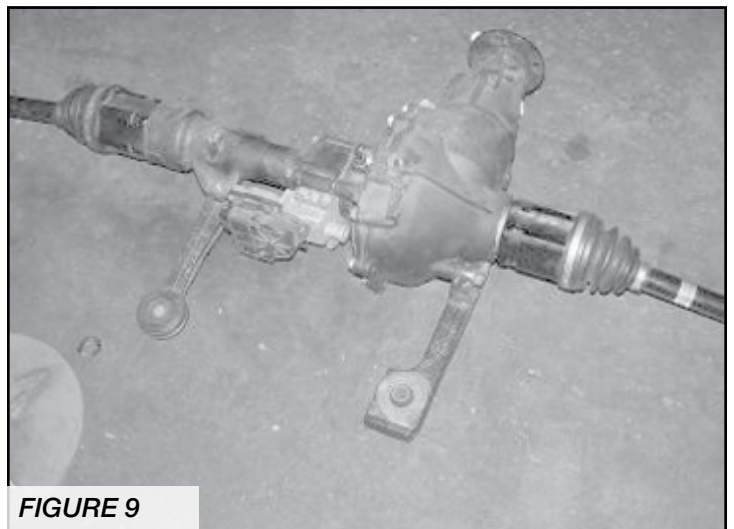


**FIGURE 8**

11. Remove and save the factory lower control arms with the hardware.

**Skip Steps 12 And 13 On 2WD Model Trucks.**

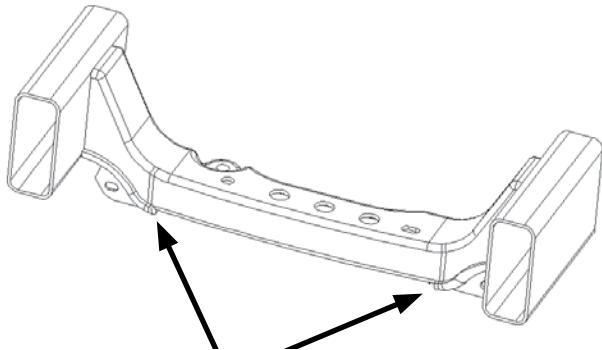
12. Disconnect the front driveshaft ONLY from the differential, do not disconnect from the transfer case. Save hardware. Do not allow driveshaft to hang freely.
13. Support the front differential with a transmission or floor jack. Disconnect all electrical, vacuum lines, and breather lines from the differential. Remove the rear differential nut and save as you will reuse it during assembly. Remove the two front differential bracket bolts from the frame. Discard the bolts, as you will not reuse them. **DO NOT SEPARATE THE C.V. AXLES FROM THE DIFFERENTIAL.** Remove the differential from the truck and set aside. **USE CARE WHEN REMOVING DIFFERENTIAL AS TO NOT DAMAGE THE C.V. Axles and 4WD VACUUM ACTUATOR ASSEMBLY. SEE FIGURE 9**



**FIGURE 9**

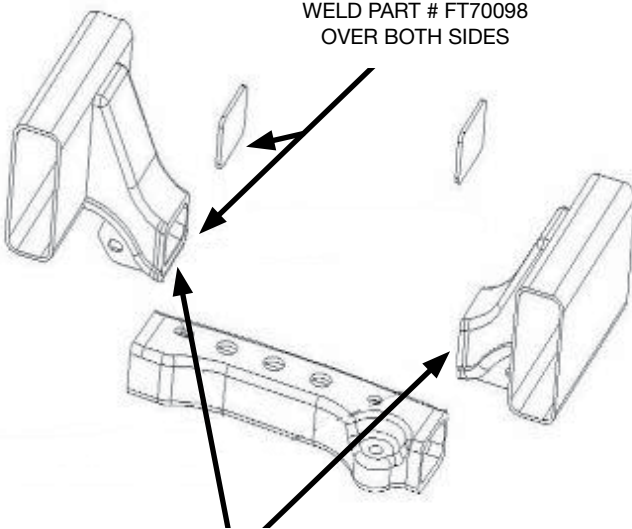
14. Locate the factory rear crossmember. Mark the crossmember 3 1/2" from outside edge of the cam pocket adjustment hole inward. On the top of the crossmember, locate the bottom hole and measure down 1/4", draw a line straight across the top of the crossmember and connect to the first line that is on the back of the crossmember. On the bottom of the crossmember, draw another line forward from the first line just beside the weld for the control arm pocket. Take care to cut the crossmember straight up and down and to not cut into the control arm pocket itself or cut out the weld. You will use a Sawzall or Die Grinder with a cutoff wheel to make these cuts. Remove the rear crossmember section. Cut and discard.

**SEE FIGURES 10-14**



CUT CENTER OF CROSSMEMBER ALONG  
EDGE OF TAB MOUNTS ON BOTH SIDES

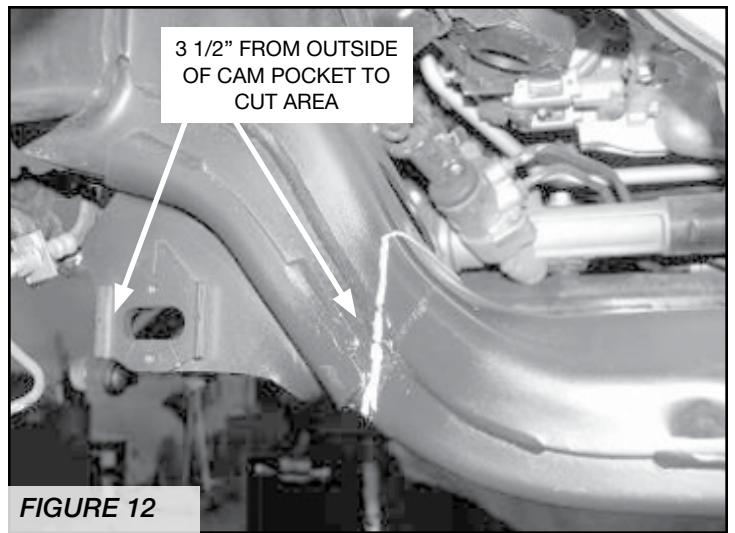
**FIGURE 10**



WELD PART # FT70098  
OVER BOTH SIDES

CUT CENTER OF CROSSMEMBER ALONG  
EDGE OF TAB MOUNTS ON BOTH SIDES

**FIGURE 11**



**FIGURE 12**



**FIGURE 13**



**FIGURE 14**



15. Locate FT70098 Weld in plate. You will need to weld in these plates to cover the holes made by cutting out the original cross member. Clean area to bare metal and weld in new plates. Let plate cool and paint with a corrosive resistant paint or under coating. **SEE FIGURES 15-17**



FIGURE 15

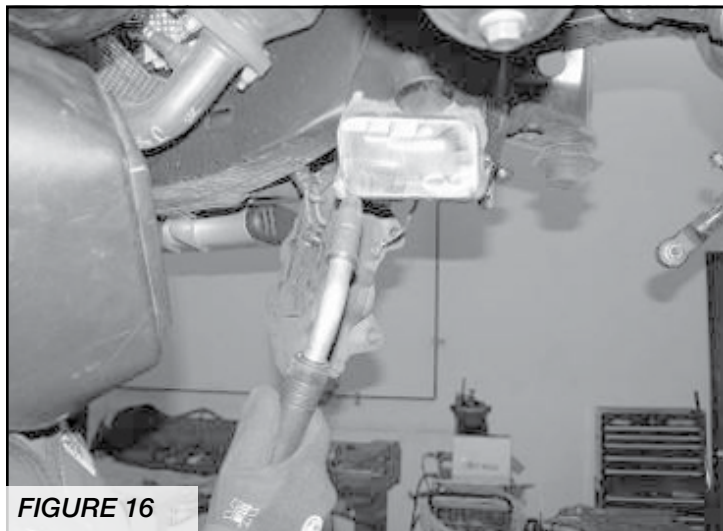


FIGURE 16



FIGURE 17

16. Working from the driver's side, mark the front frame section / body mount 5 3/4" from the face of the frame and the back at 8" from the frame. **SEE FIGURES 18-20**

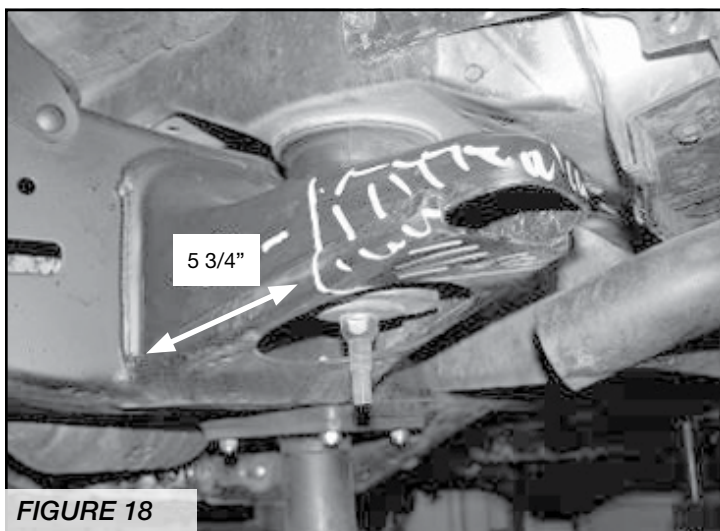


FIGURE 18

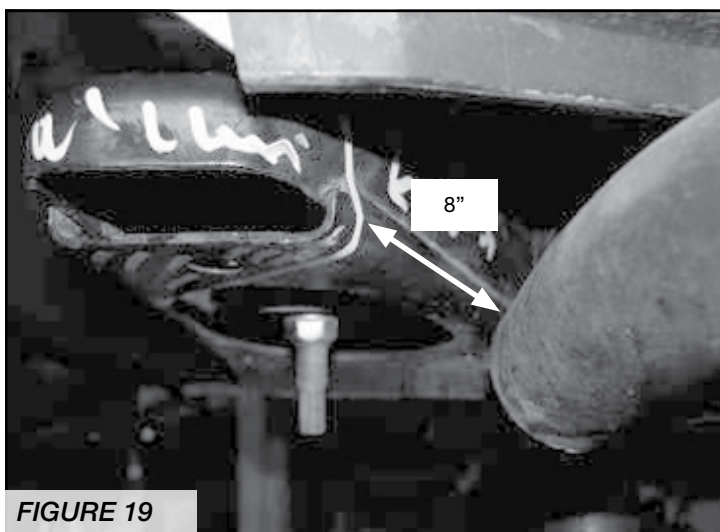


FIGURE 19

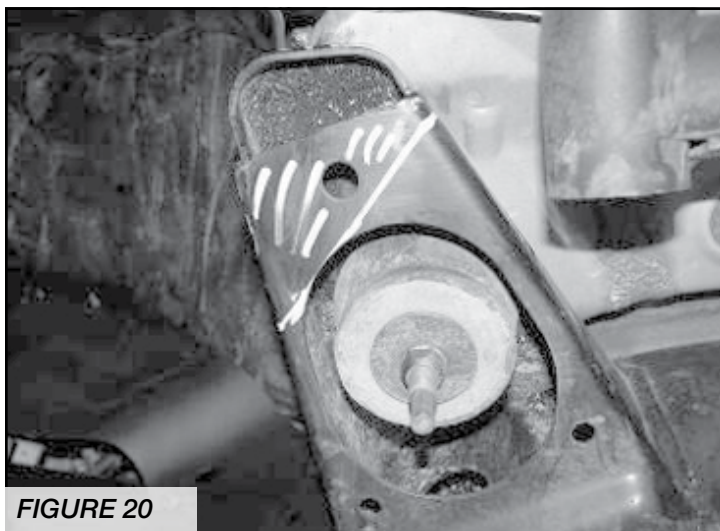


FIGURE 20

17. Use a sawzall and cut the marked area from the mount. Next, sand and clean the cut area on the mount. Locate FT70094 Weld-in Plate. Check fit the plate against the mount for proper fitment (it may be necessary to sand the mount for proper fitment of the plate). Weld the plate in and paint after it has cooled. **SEE FIGURES 21-24**

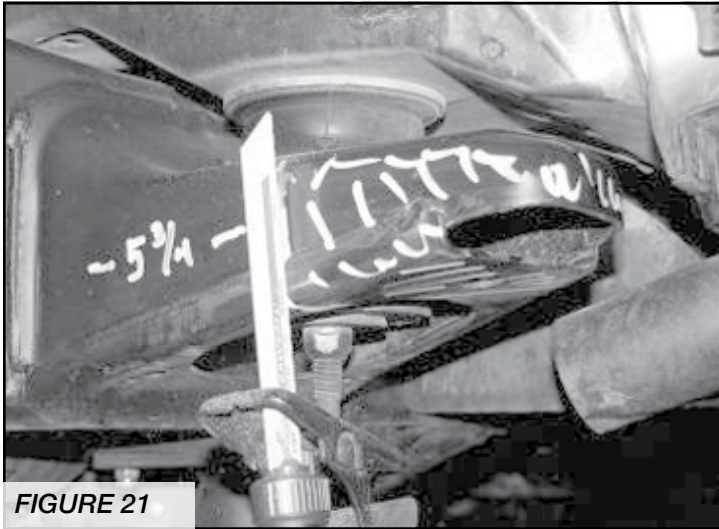


FIGURE 21

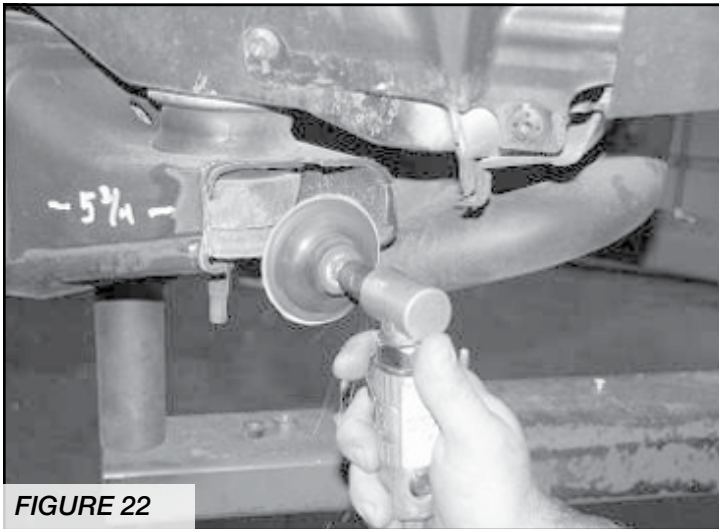


FIGURE 22

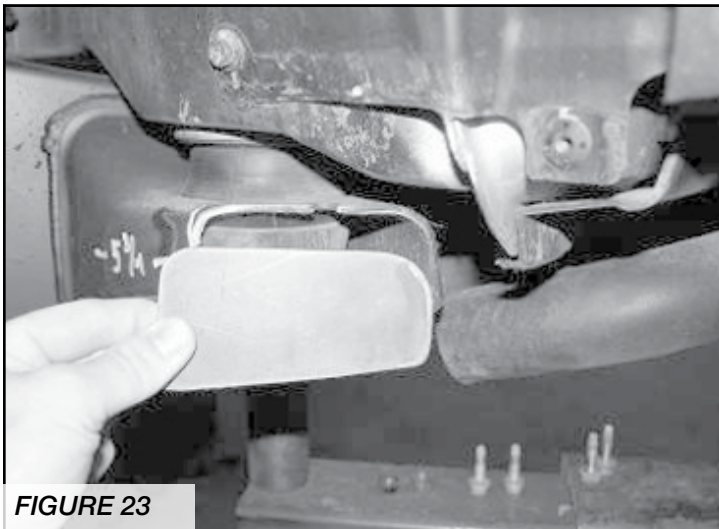


FIGURE 23

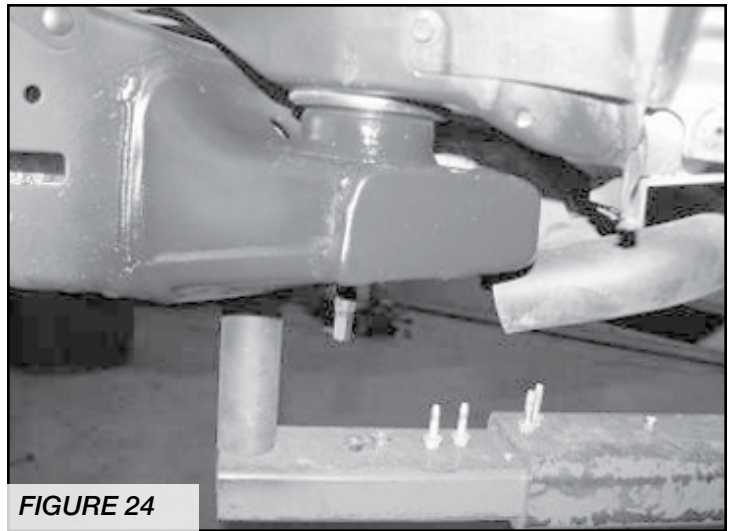


FIGURE 24

***Skip Step 18 On 2WD Model Trucks.***

18. Locate the front differential and remove the factory front mounts. Discard the mounts and save the hardware. Locate FT70053 Driver Diff mount, FT70054 Pass Diff mount, and FT70071 Bushing and Sleeve Kit. Install the four bushings and the two larger I.D. sleeves into the new mounts. Using the factory hardware and some of the supplied thread-locking compound, mount the new diff mounts to the front differential. Torque the hardware to 75 ft. lbs. **SEE FIGURE 25**

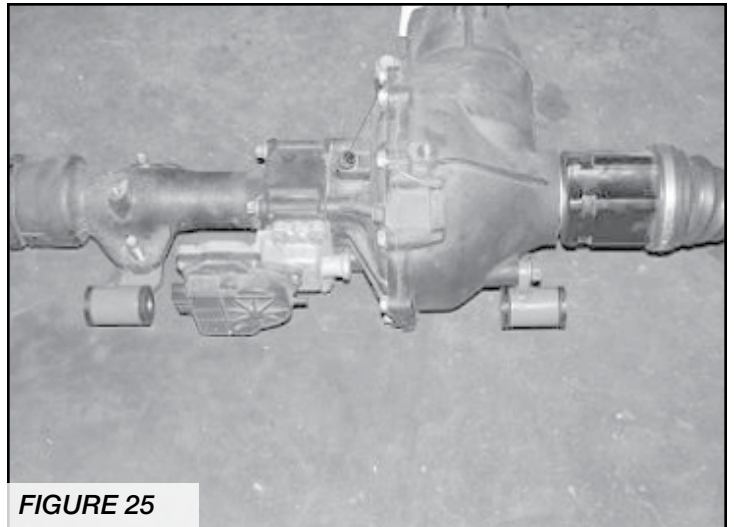
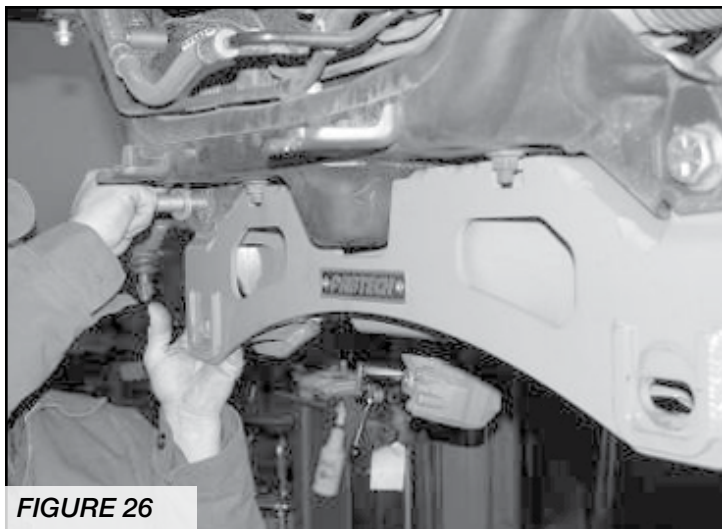


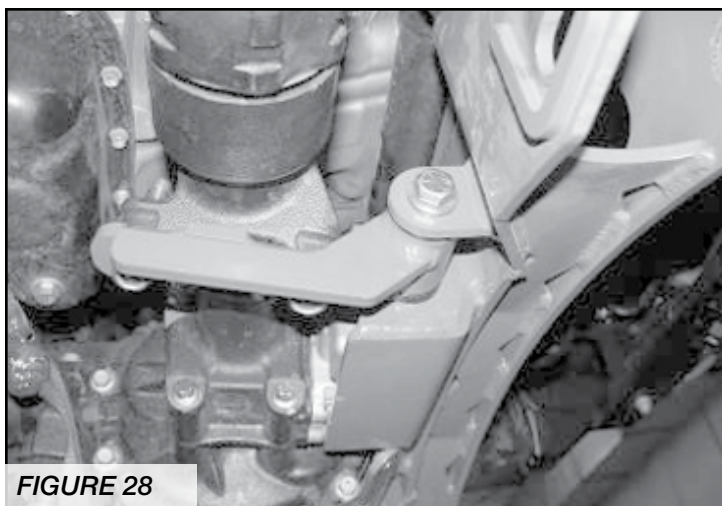
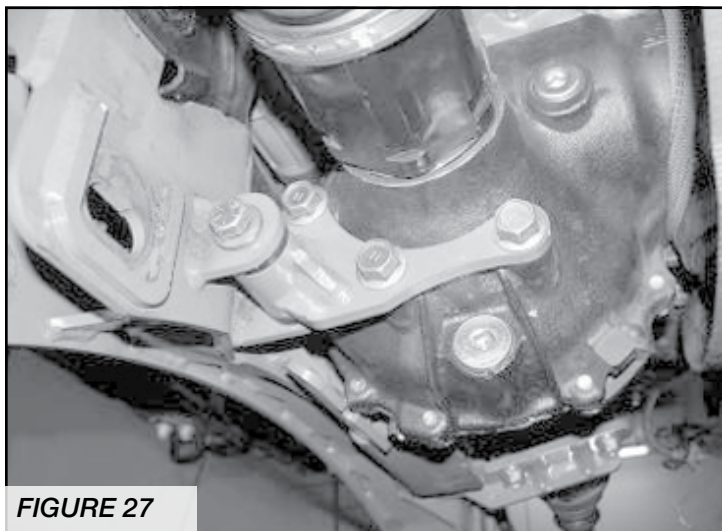
FIGURE 25

19. Locate the Fabtech front crossmember FT70051 06-09 models FT70162 10-12 models, with the supplied  $\frac{3}{4}$ " x 4 1/2" bolts, nuts, and washers, attach the crossmember to the factory control arm pockets, leave loose at this time. **SEE FIGURE 26**

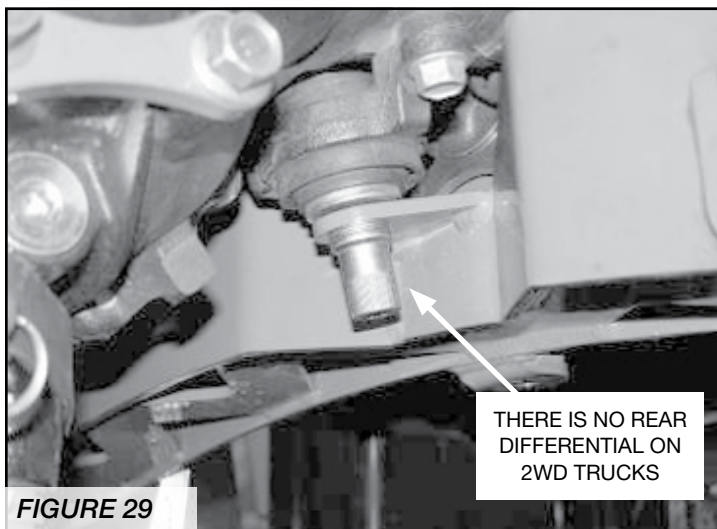


***Skip Step 20 On 2WD Model Trucks.***

20. Install the differential up onto the front crossmember with the supplied  $\frac{1}{2}$ " x 4" bolts and hardware. Support the differential with a transmission jack. Leave loose at this time. **SEE FIGURES 27-28**

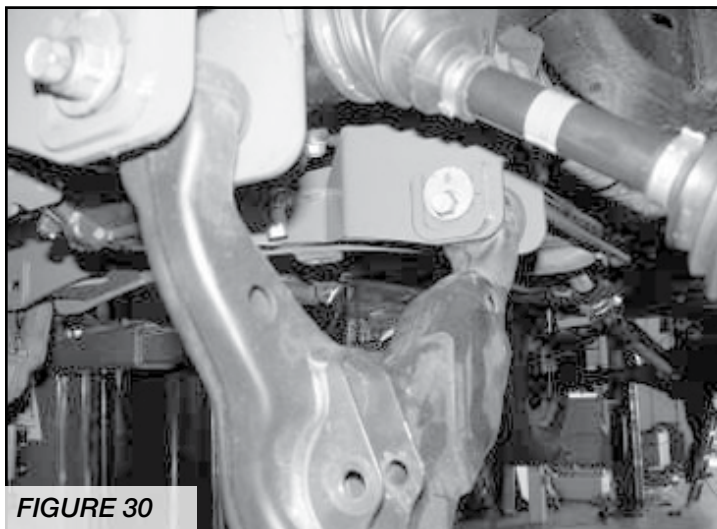


21. Locate the Fabtech rear crossmember FT70052 06-09 models FT70163 10-12 models, with the supplied 9/16"x5 bolts, nuts, and washers install the crossmember to the factory control arm pockets. Leave loose at this time. Re-install the factory rear differential nut at this time. **SEE FIGURE 29**



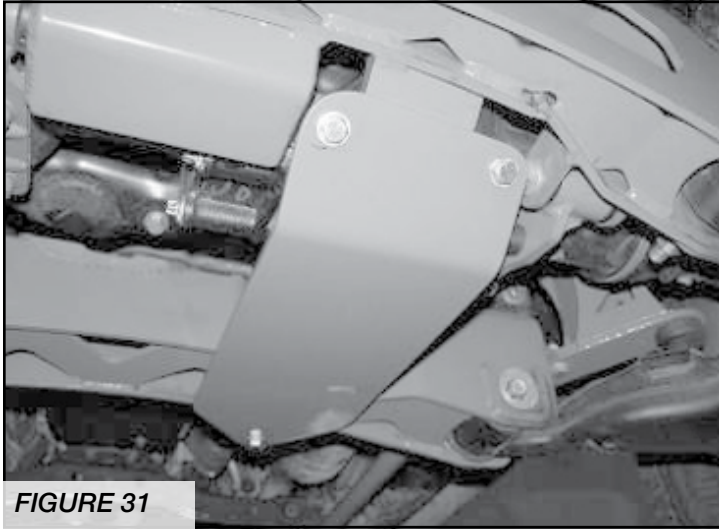
***Skip Step 22 On 2WD Model Trucks.***

22. Locate the previously removed factory hardware for the front driveshaft and install with the supplied thread-locking compound on the bolts and torque to 50 ft lbs. Re-connect all electrical, vacuum lines, and breather lines back to the differential.
23. Install the factory lower control arms, using stock alignment bolts and hardware, set cams in the middle of their adjustment range and leave loose. **SEE FIGURE 30**



24. Locate FT70058 skid plate. Attach using the supplied

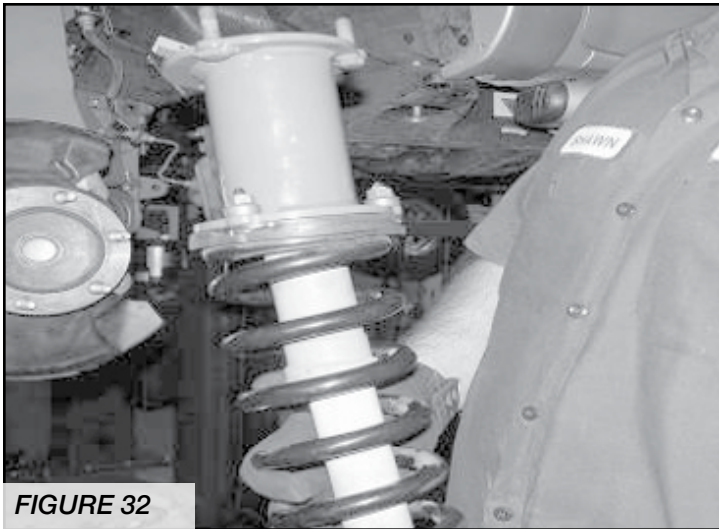
hardware (front mount) 5/16"x1 1/4" bolts, nuts, and washers (rear mount) 1/2"x 1 1/2" bolt, nut, and washer. Leave loose. **SEE FIGURE 31**



**FIGURE 31**

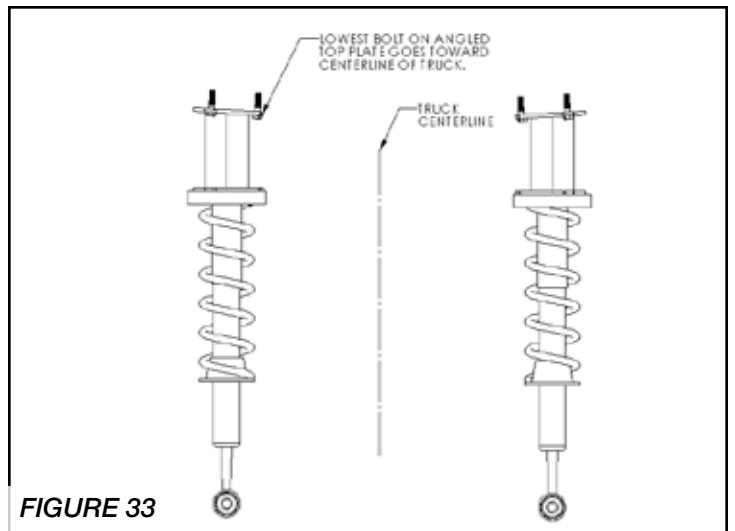
***Follow Step 25 For The Basic System Or  
Follow Step 26 For The Performance System.***

25. Locate the factory shock assembly and hardware. Locate the FT70055 Coil Spacers and supplied 3/8" C-Lock nuts and Washers. Position the spacer onto the top of the shock assembly so that the shortest side of the spacer is angled in towards the shock bucket on the vehicle and attach to the shock with the factory hardware. This must also align with the bottom mounting point of the shock assembly to mount into the lower control arm. Insert the shock assembly up into the bucket and attach with the supplied 3/8" hardware. Leave loose at this time. Place the bottom of the shock into the lower shock mount and attach with the factory hardware. Torque the top 3/8" hardware to 30ft. lbs., factory hardware to 30 ft. lbs., and the lower bolt to 100 ft. Lbs. **SEE FIGURES 32-33**



**FIGURE 32**

PHOTO SHOWS BASIC SPACER ON FACTORY STRUT



**FIGURE 33**

26. Locate and install FTS26008 Dirt Logic Coilover shocks as described in the instructions enclosed with the coilovers. **SEE FIGURE 34**

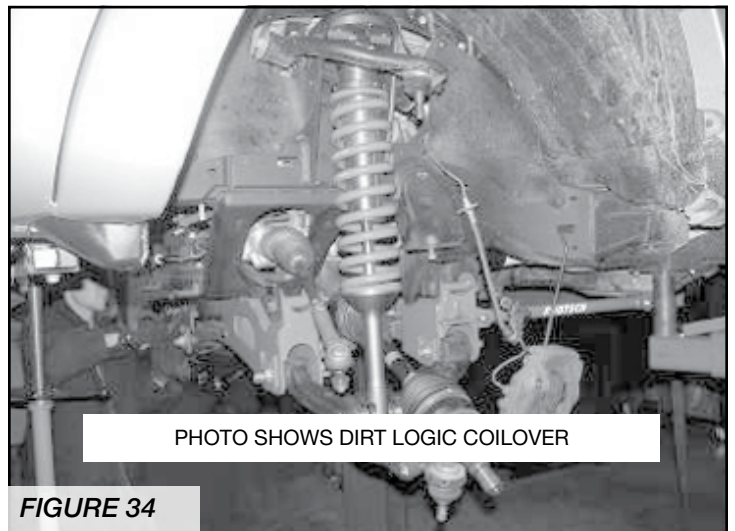
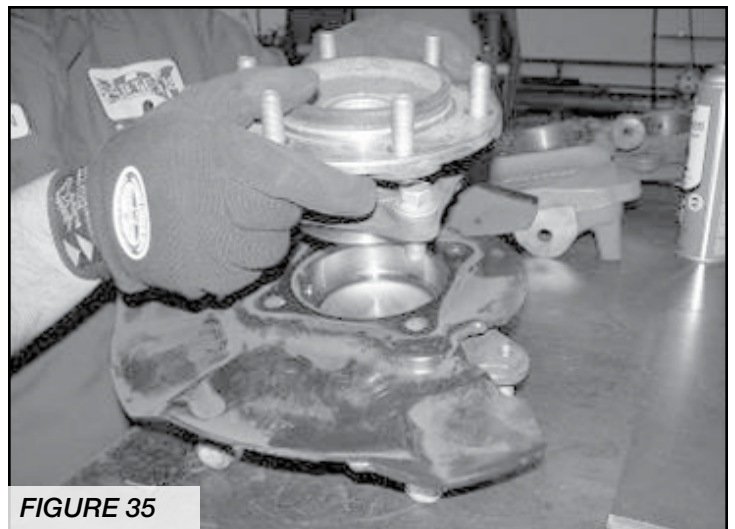


PHOTO SHOWS DIRT LOGIC COILOVER

**FIGURE 34**

27. Locate the factory steering knuckles and remove the hubs, backing plates, inner seal, and the dust covers. Locate the new Fabtech FTS70234D and FTS70234P steering knuckles. Install the factory hubs, backing plates, factory inner seal, and the dust covers with the factory hardware and supplied thread-locking compound. Tighten to factory torque specs. **SEE FIGURES 35-38**



**FIGURE 35**



FIGURE 36

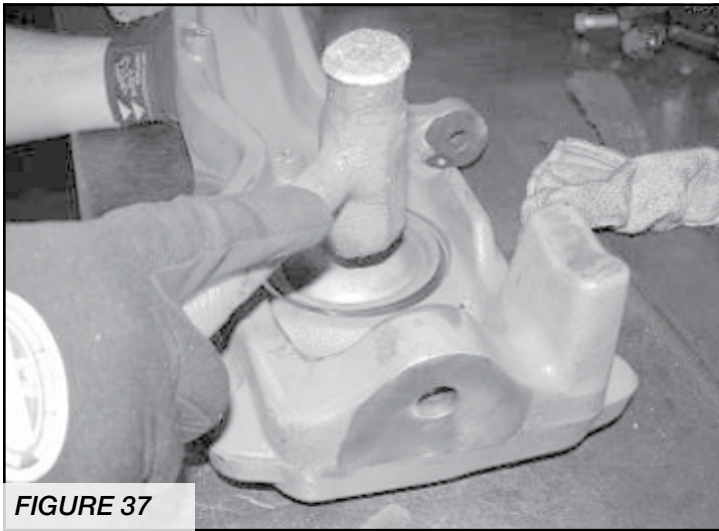


FIGURE 37

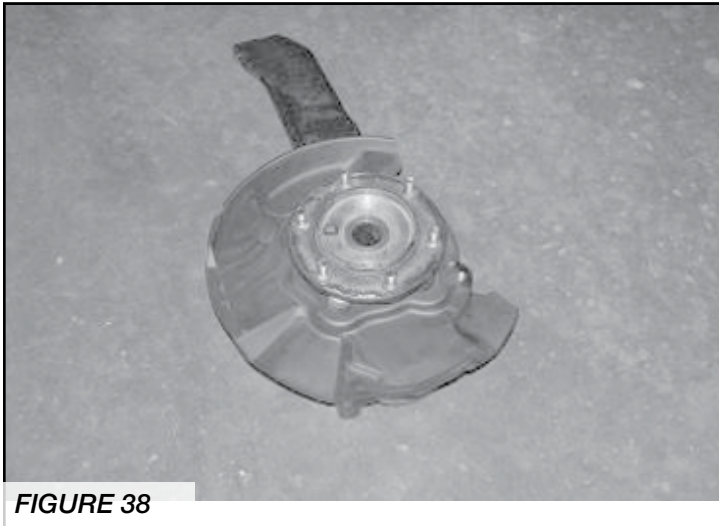


FIGURE 38

28. Support the lower arm with a floor jack and install the new assembled steering knuckle to the lower ball joint with the factory castle nut and supplied cotter pin. Raise the jack enough to locate the knuckle up into the upper ball joint (pull down on upper arm) and attach with the factory castle nut and supplied new cotter pin. Upper ball joint torque 81ft-lbs. Lower ball joint 103 ft-lbs.

**SEE FIGURE 39**

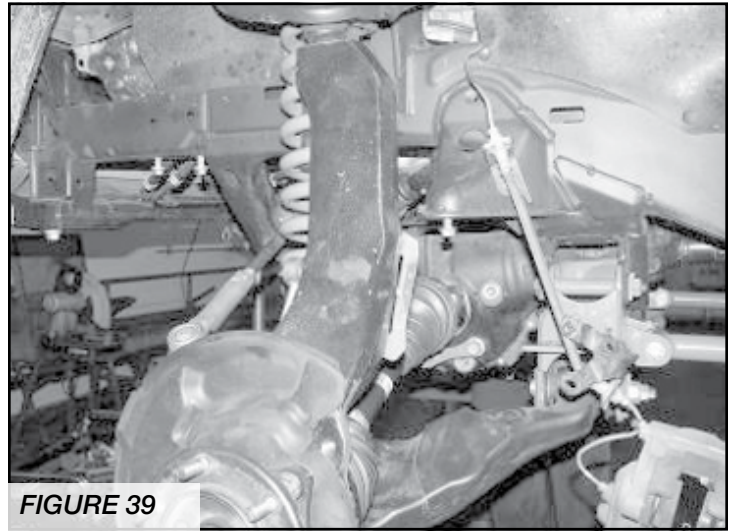


FIGURE 39

29. Torque factory control arm pocket bolts to 100 ft lbs., the 3/4" front crossmember bolts to 110 ft. lbs., the 9/16" rear crossmember bolts to 100 ft. lbs., the 1/2" differential mounts to 75 ft. lbs., the 1/2" skid plate bolt to 75 ft. lbs., and the 5/16" skid plate bolts to 20 ft. lbs.

30. Locate the factory brake line tab next to upper control arm. Unbolt the bracket from the frame save hardware and bracket. You will need to carefully pull the hard brake line down 4". Locate FT70061 brake line drop bracket and attach the bracket to the frame with the factory hardware in the upside down J formation. Attach factory bracket to the new bracket using the supplied 5/16" x 1" bolt, nut, and washers. **SEE FIGURE 40**

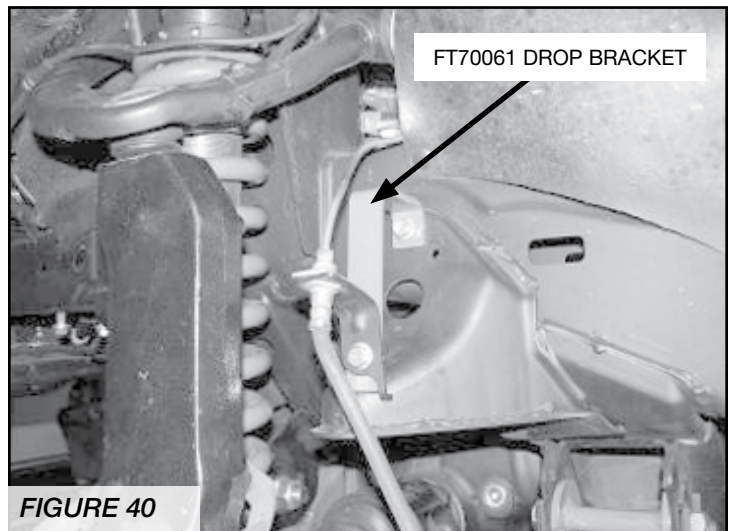


FIGURE 40

31. Locate FT70063 & FT70064 (drv. / pass.) spindle brake line bracket. Attach to the Fabtech knuckle using the supplied  $\frac{1}{4}$ " x  $\frac{3}{4}$ " bolts, washers, and split washers. Attach the factory bracket to the new brake line bracket using the supplied  $\frac{1}{4}$ " x  $\frac{3}{4}$ " bolt, washer, & split washer. **SEE FIGURES 41-44**



FIGURE 41

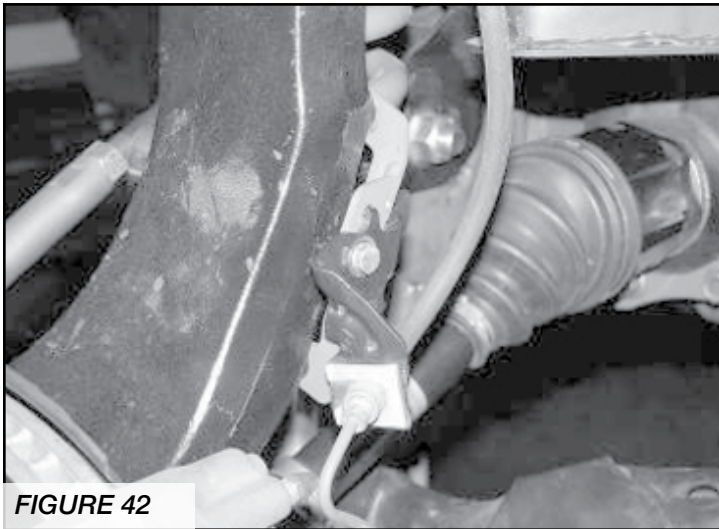


FIGURE 42



FIGURE 43



FIGURE 44

32. Install brake rotors & brake calipers with the factory hardware and thread lock compound. Route the ABS onto backside of the steering knuckle. There should be enough slack just inside the wheel well to pull the line down for the factory sensor to bolt into the new Fabtech steering Knuckle. Using the supplied adel clamps and the  $\frac{1}{4}$ " x  $\frac{3}{4}$ " bolts, washers, & split washers, reinstall the factory ABS Sensor into the Fabtech Knuckle. **SEE FIGURES 45-46**

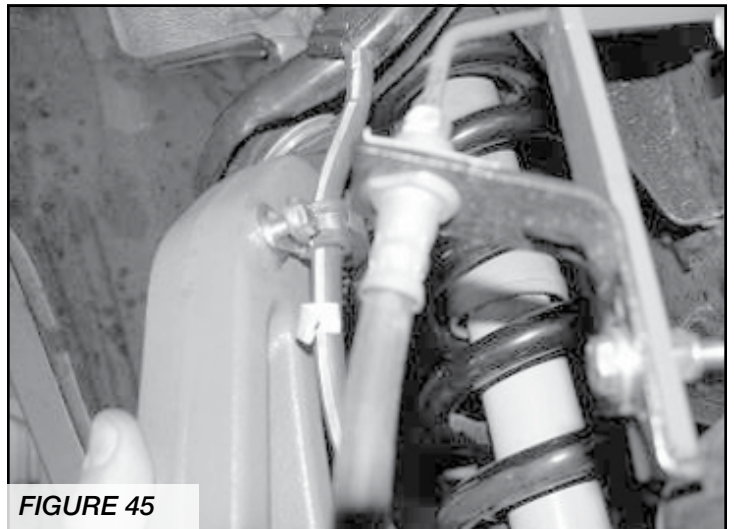


FIGURE 45

33. Now attach the tie rod ends with the factory castle nut and supplied cotter pin. (torque the tie rod ends to 70 ft. lbs.)

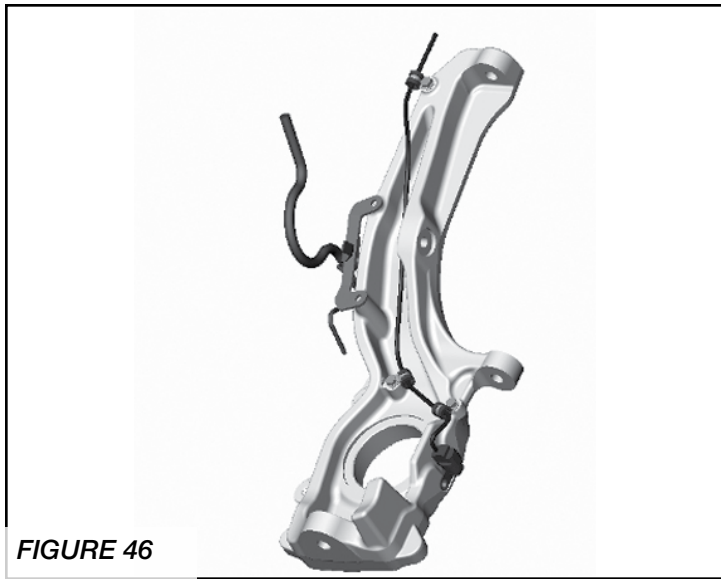


FIGURE 46

34. Remove factory bump stop and discard. Locate FT70056 (drv.) & 70057 (pass.) bumpstop drop bracket. Attach the top of the bracket to the factory bump stop position using the supplied 10mm x 30mm bolt and washer. Attach the two bottom holes of the bracket to the rear Fabtech crossmember, using the supplied 3/8" x 1 1/4" bolts, nuts, & washers. Now locate the supplied FTS88 Bump Stop, attach to the new bump stop bracket using the supplied 3/8" nut, & washer. **SEE FIGURES 47-48**

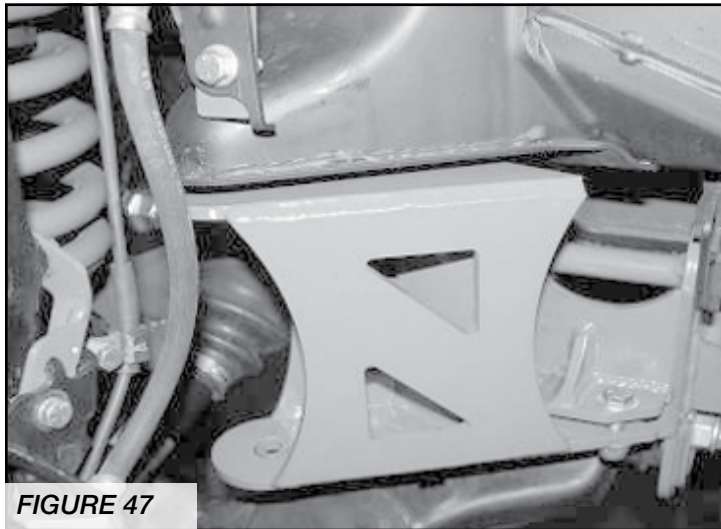


FIGURE 47

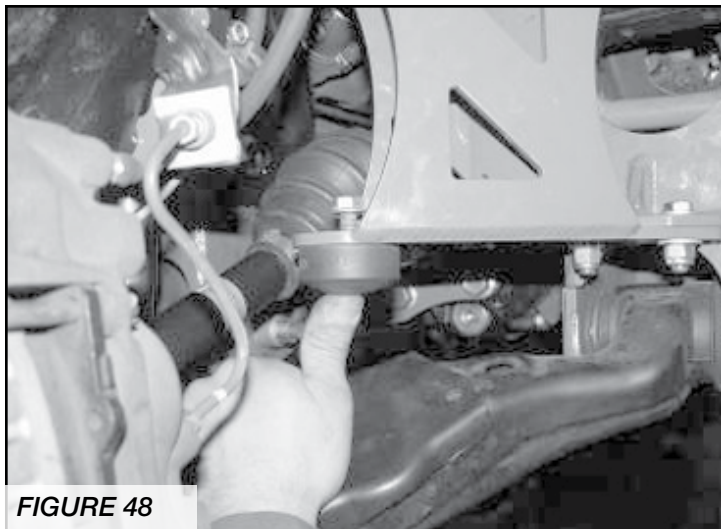


FIGURE 48

35. Locate FT70100BK (2006-09) or FT70164BK (2010-12) Driver Sway Bar Drop Bracket, and FT70101BK (2006-09) or FT70165BK (2010-12) Passenger Sway Bar Drop Bracket and the factory sway bar, with hardware. Also locate the supplied 3/8" x 1 1/4" hardware. Position the new drop bracket on the frame so the sway bar will be mounted forward of its factory position and attach with the factory hardware. Use a paint pen or center punch and mark the core support / frame at the front tab of the drop bracket. Use a drill with a 1/2" bit and drill a hole into the support. Locate FT70106 Sway Bar Bracket Nut Tab and the supplied 3/8"x 1 1/4" bolt, flat washer, and split washer. Insert the nut tab into the frame and attach with the 3/8" hardware. **SEE FIGURE 49**

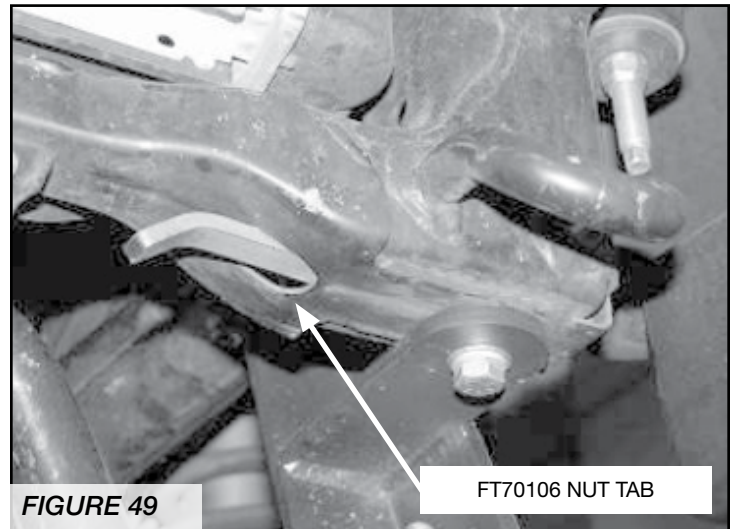


FIGURE 49

36. Install the sway bar to the new drop brackets with the supplied 3/8" hardware. (the sway bar will need to be mounted upside down from the factory position). **SEE FIGURE 50**

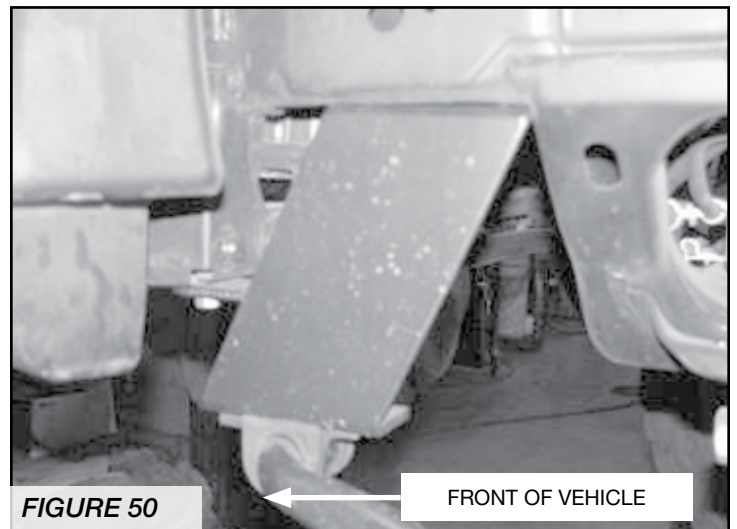
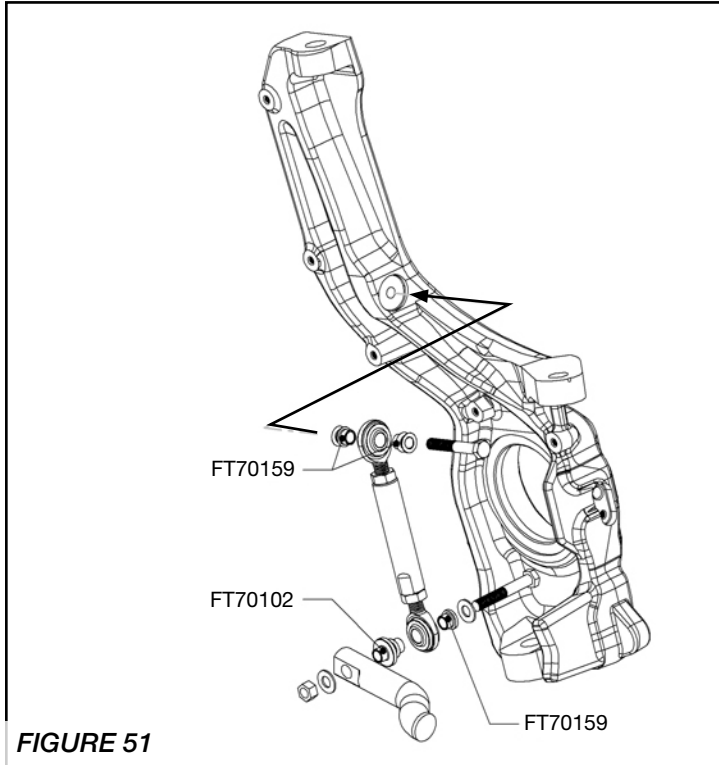


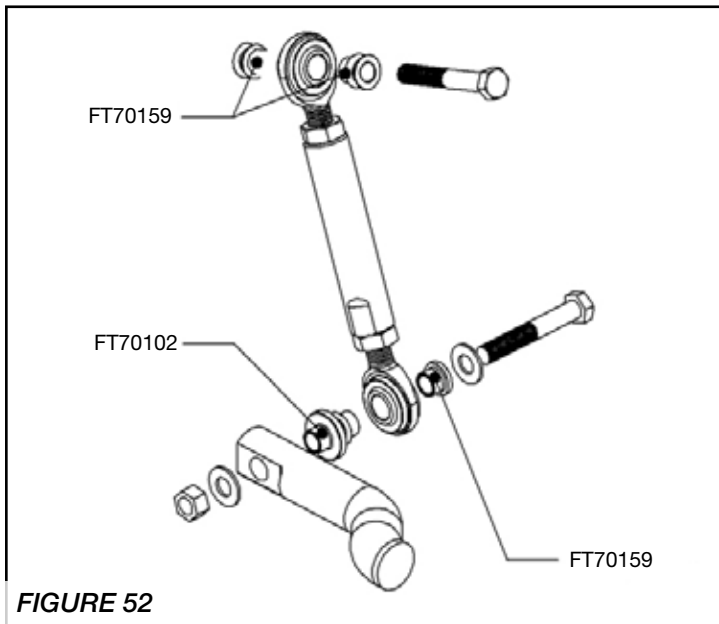
FIGURE 50

37. Locate FT70105 Sway Bar End Link, FT95023 ½” Heims, and supplied ½” Jam Nuts. Thread the jam nuts all the way onto the heims. Insert an assembled heim into each end of the end links and leave loose. Locate FT70102 (sway bar hat) and FT70159 misalignment) and the supplied 3/8” x 2 ¼” hardware. Insert the misalignments into the heim on one end and attach to the sway bar. Locate FT70159 misalignments and the supplied 3/8” x 3” hardware. Insert the misalignments into the upper heim and attach it to the Fabtech steering knuckle. Torque the 3/8” hardware to 30 ft. lbs.

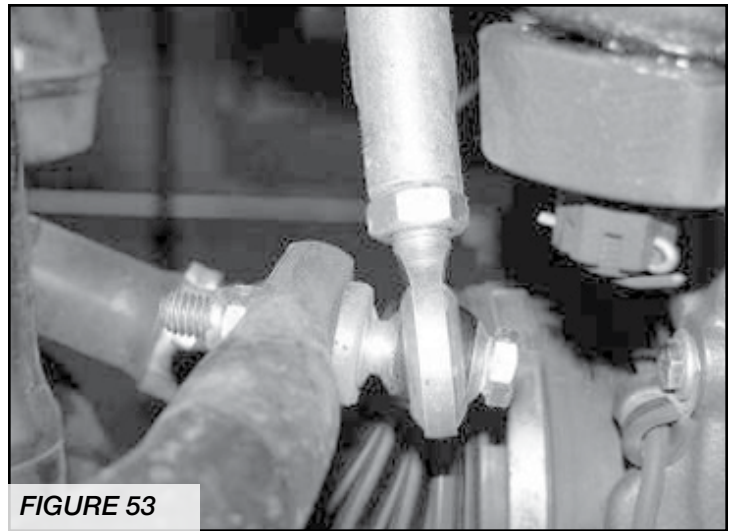
**SEE FIGURES 51-54**



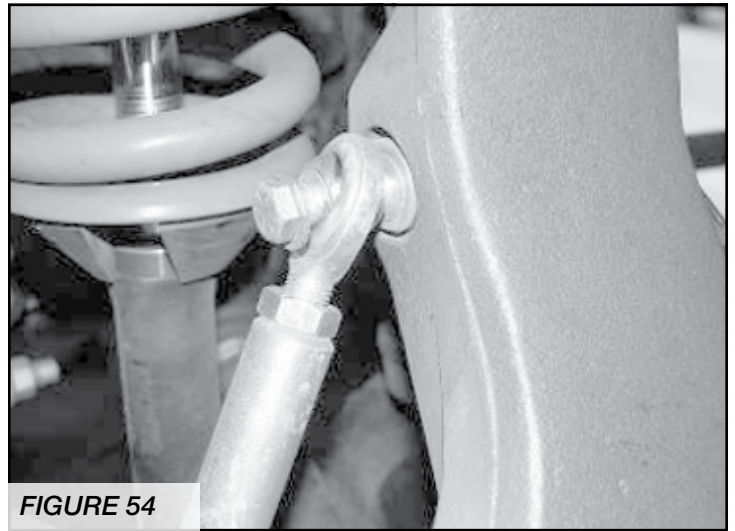
**FIGURE 51**



**FIGURE 52**

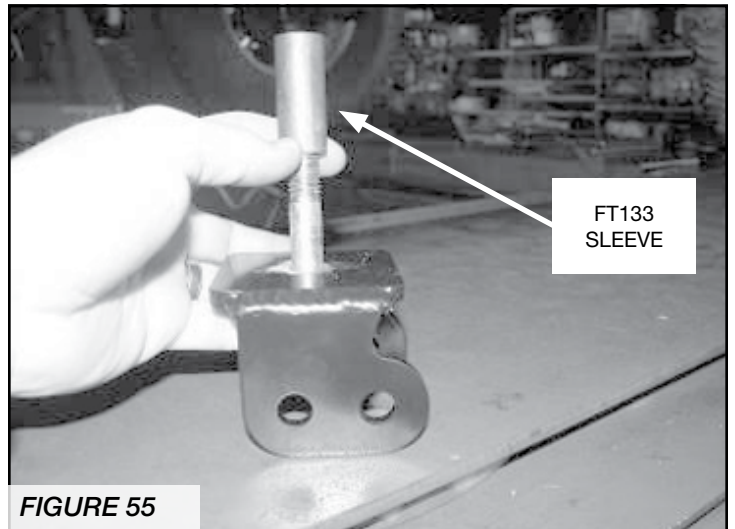


**FIGURE 53**



**FIGURE 54**

38. Locate the FT70059 Impact Strut mounts, FT133 sleeve, & ½”x 3” bolts, nuts, and washers. Install the impact strut mounts to the factory transmission crossmember with the sleeve on top of the bracket. Note: Some vehicles require drilling out the top hole in the crossmember. Some vehicles also do not have a “pocket” for the bracket to set inside of the crossmember requiring the use of the provided ½” x 3 ½” bolt instead of the 3” bolt and FT133 Sleeve. Torque to 75ft. lbs. **SEE FIGURES 55-57**



**FIGURE 55**



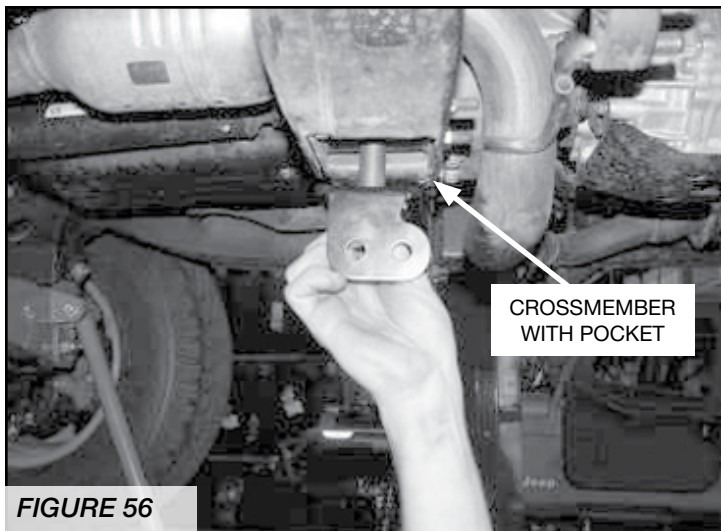


FIGURE 56

CROSSMEMBER WITH POCKET

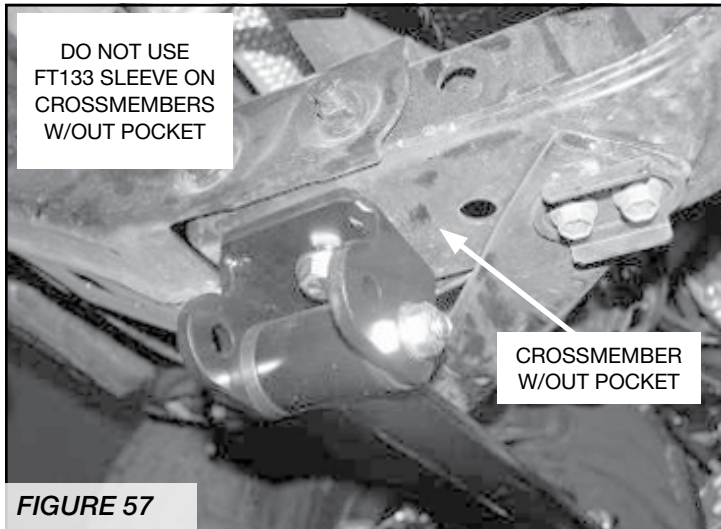


FIGURE 57

DO NOT USE FT133 SLEEVE ON CROSSMEMBERS W/OUT POCKET

CROSSMEMBER W/OUT POCKET

39. Locate FT70011 Impact strut tubes and FT1044 Bushing kit. Install the bushings into the strut tubes. Attach the strut tubes to the rear Fabtech crossmember then to the strut brackets on the transmission crossmember with the supplied 7/16" x 3 1/2" bolts and hardware. Torque to 50 ft. lbs. **SEE FIGURE 58**

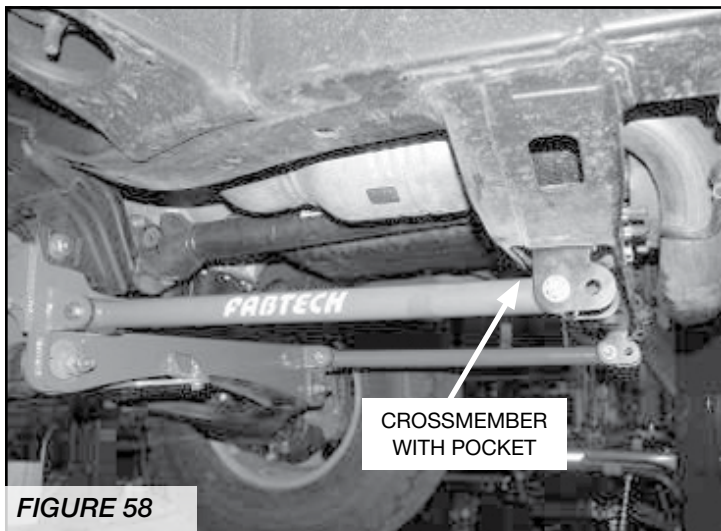


FIGURE 58

CROSSMEMBER WITH POCKET

40. Install the wheels and tires and torque to the wheel manufactures specs. Turn wheels left to right to check for proper clearance between brake lines / ABS Lines to tires and wheels with vehicle hanging and on the ground. Reroute lines as required for clearance.

## REAR SUSPENSION

41. Jack up the rear end of the vehicle and support the frame rails with jack stands. Supporting the rear differential remove and discard the rear shocks, save hardware.
42. Disconnect the brake line brackets on the lower link arms, upper link arm mount on the axle, the mount at the top of the differential housing, and the frame on the driver's side. Remove the ABS line from the frame on the passenger side, save all hardware. **SEE FIGURES 59-63**

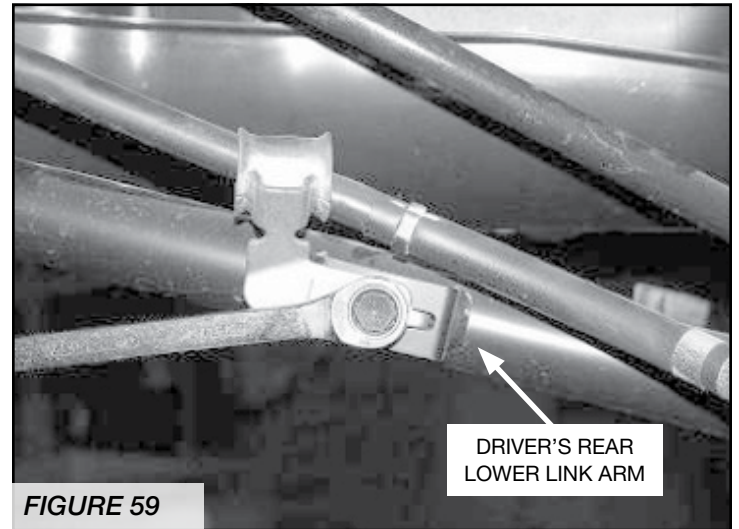


FIGURE 59

DRIVER'S REAR LOWER LINK ARM

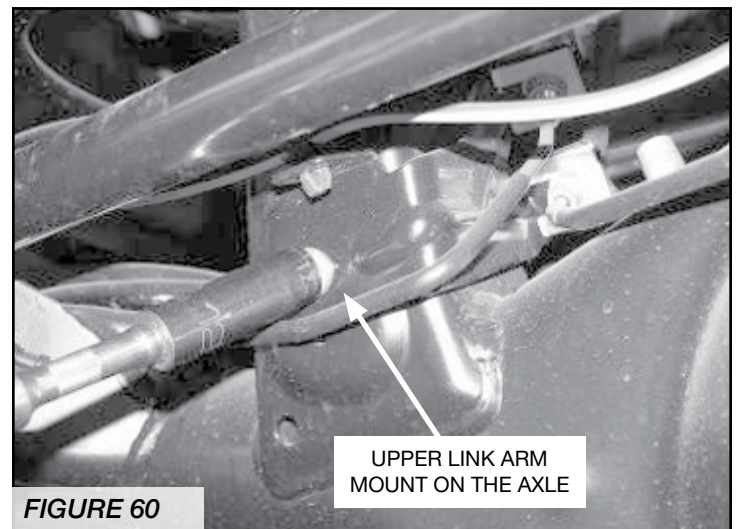


FIGURE 60

UPPER LINK ARM MOUNT ON THE AXLE

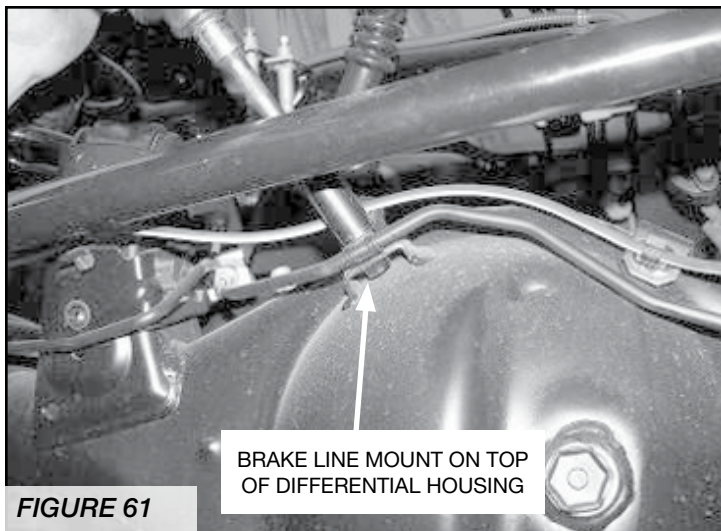


FIGURE 61

BRAKE LINE MOUNT ON TOP OF DIFFERENTIAL HOUSING

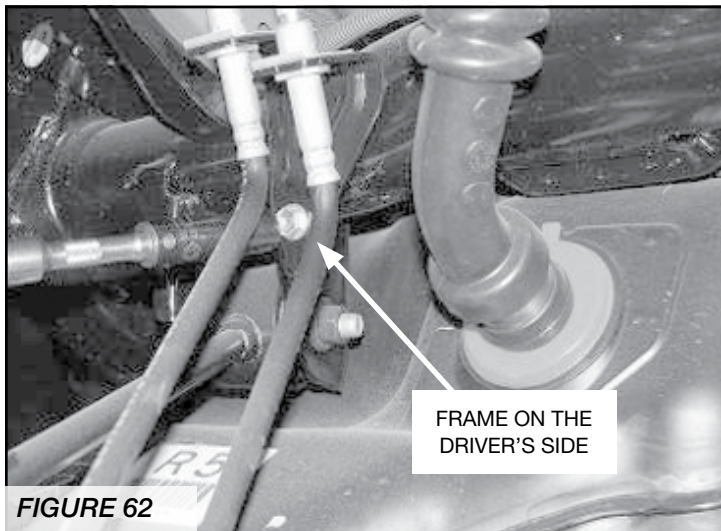


FIGURE 62

FRAME ON THE DRIVER'S SIDE

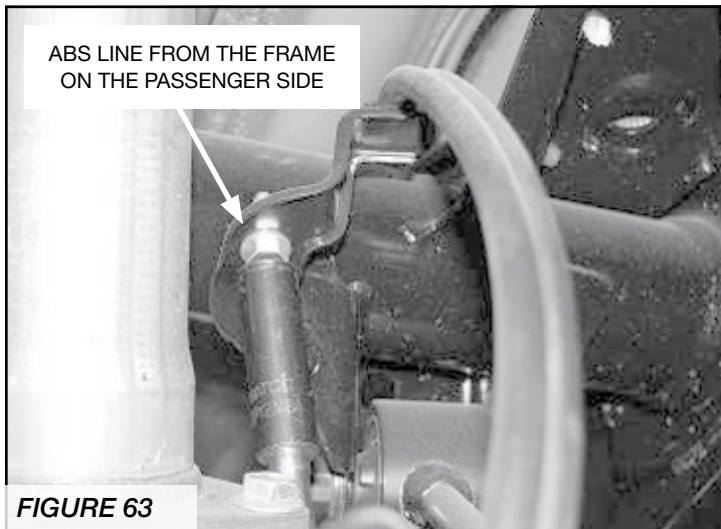


FIGURE 63

ABS LINE FROM THE FRAME ON THE PASSENGER SIDE

43. Remove and save the trac bar, coil springs, and the bumpstops on the frame.

44. Locate FT70084 (upper) and FT70085 (lower) Link Arms and FT70092 Bushing kit. **NOTE:** Press FT1007 bushings and longer sleeves into FT70085BK (lower link). Install (1) FT1007 bushing, (1) FT1037 bushing and the shorter sleeve into the FT70084BK (Upper link) coordinating with the offset zerk fitting hole. Install the supplied zerk fittings. **SEE FIGURES 64-65**

45. Remove the driver lower link and install an assembled Fabtech link with the gussets facing down using the stock hardware. Repeat on the passenger lower link. **SEE FIGURES 66-67**

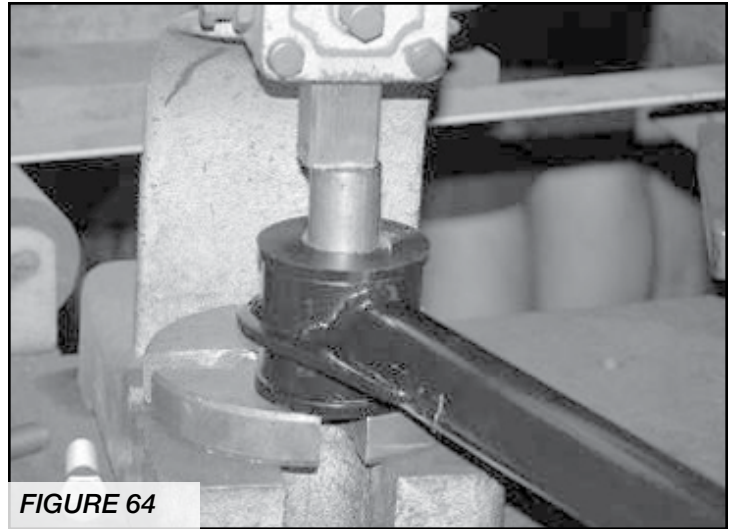


FIGURE 64

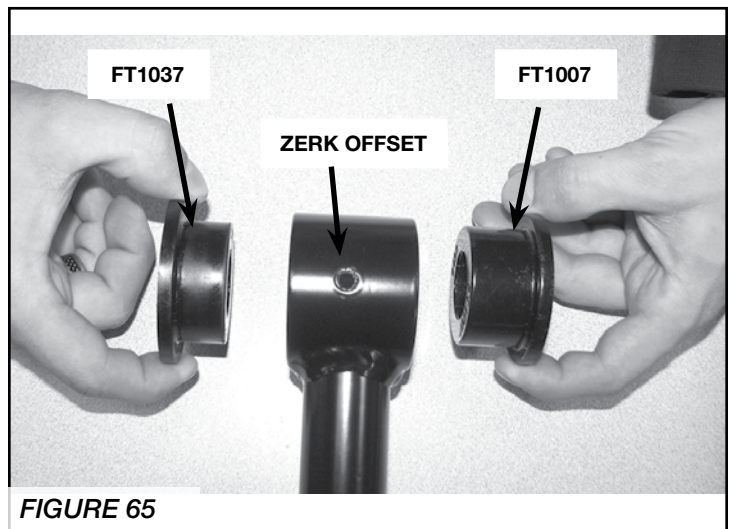


FIGURE 65

46. Remove the driver upper link and install an assembled Fabtech link with the gusset facing upward in the frame pocket and down at the axle mount with the stock hardware. Repeat on the passenger upper link. **SEE FIGURE 68**

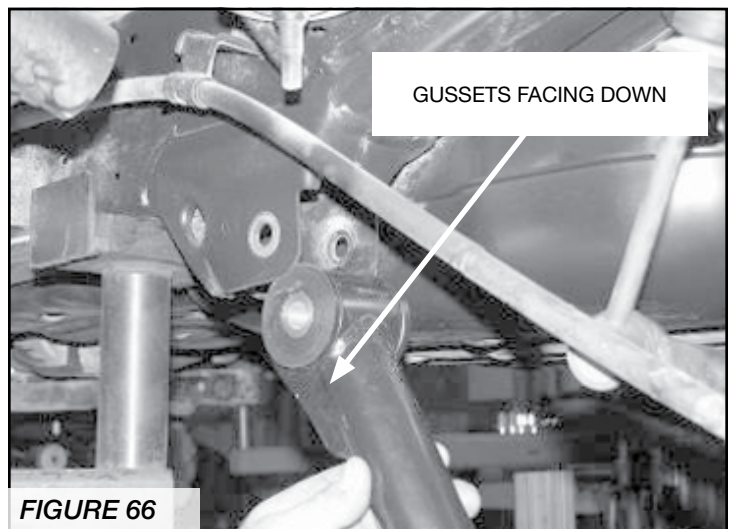
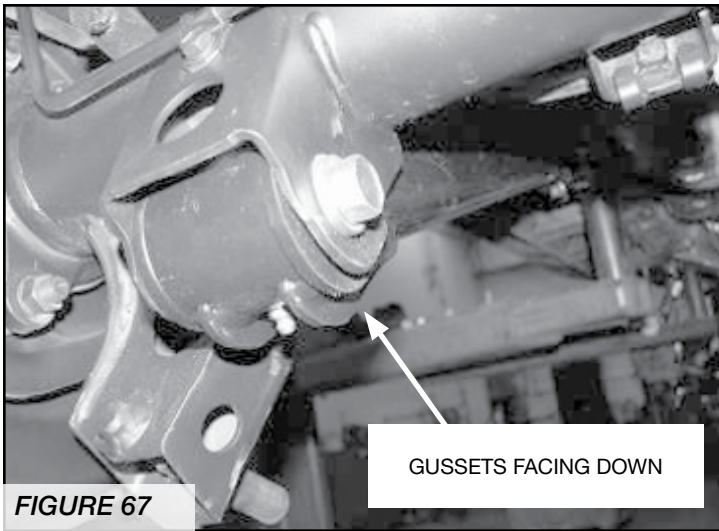


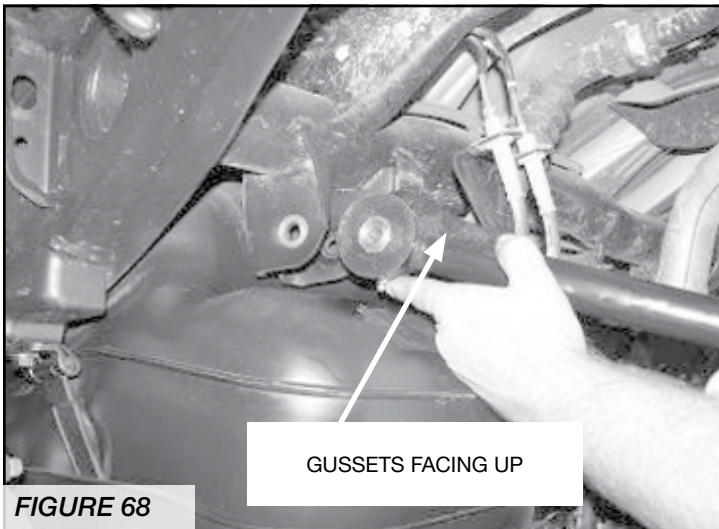
FIGURE 66

GUSSETS FACING DOWN

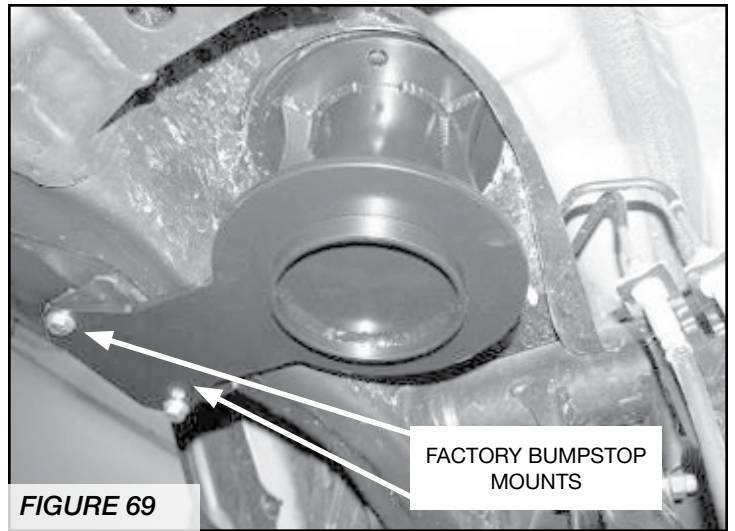


**FIGURE 67**

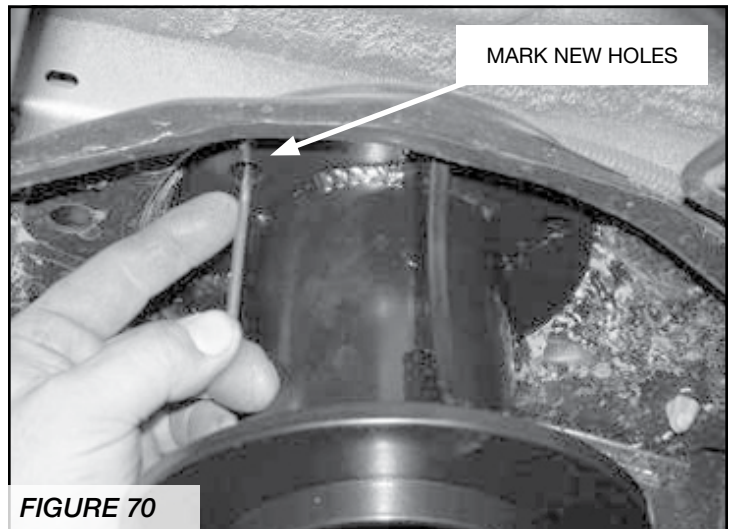
47. Working from the driver side, locate FT70086 Rear Coil Spacers and the supplied 3/8" & 8mm hardware. Position the coil spacer up into the coil bucket on the frame and attach to the factory bumpstop mount with the 8mm hardware (only tighten enough to hold the spacer in position). Mark the three holes in the spacer to the coil bucket and remove the spacer. **SEE FIGURES 69-70**



**FIGURE 68**

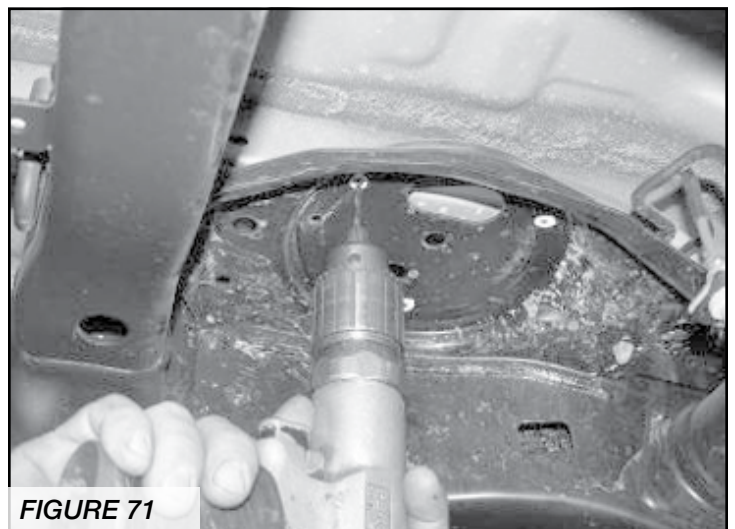


**FIGURE 69**



**FIGURE 70**

48. Use a drill with a 3/8" bit and drill out the three holes in the bucket. Install the spacer with the 3/8" hardware. Leave loose. Locate FT70093 Rear Bumpstop Bracket, supplied 5/16" hardware, and the factory bumpstop. Mount the factory bumpstop to the new bracket with the 5/16" hardware. Position the new mount to the bottom of the coil spacer and attach both to the factory bumpstop mount with the 8mm hardware. Torque the 3/8" hardware to 30 lbs. and the 5/16" & 8mm hardware to 20 lbs. **SEE FIGURES 71-74**



**FIGURE 71**

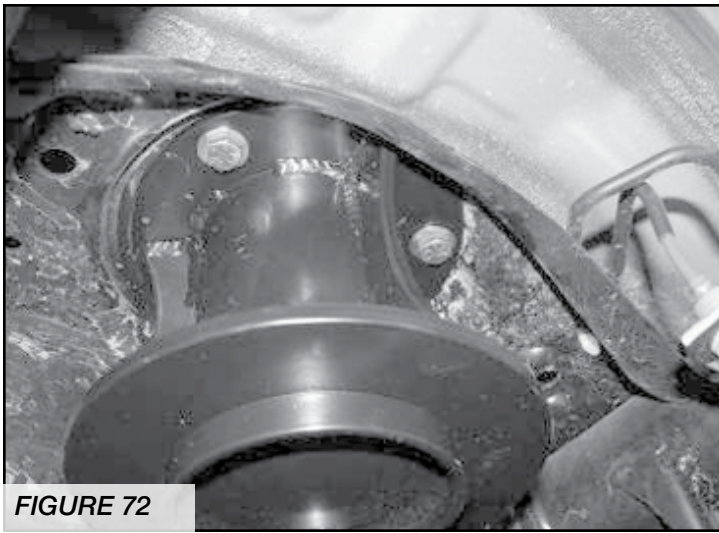


FIGURE 72

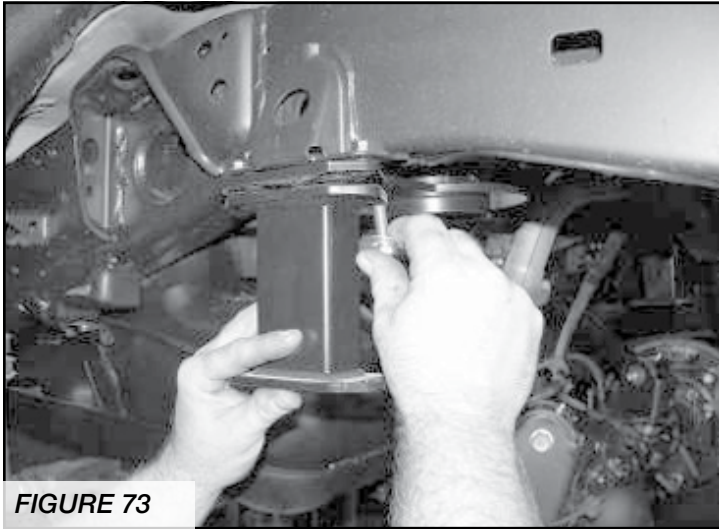


FIGURE 73

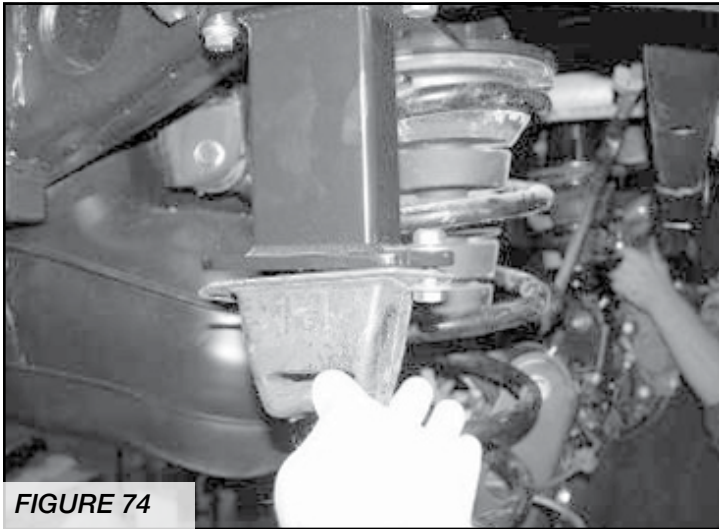


FIGURE 74

49. Repeat steps 46 & 47 on the passenger side.

50. Locate the factory rear coils and bumpstop. Use a coil spring compressor and install the coils (with the bumpstops inside) onto the new spacer and the axle mount. The bottom end of the coil spring must set against the stop on the axle mount for proper fitment and ride height. **SEE FIGURES 75-76**

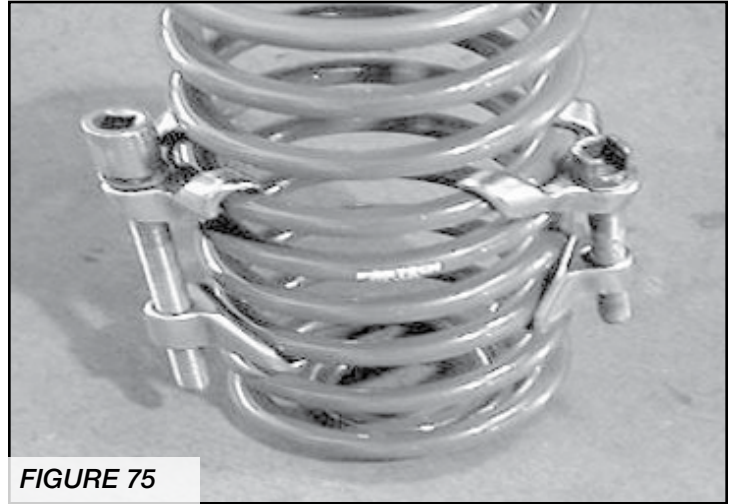


FIGURE 75

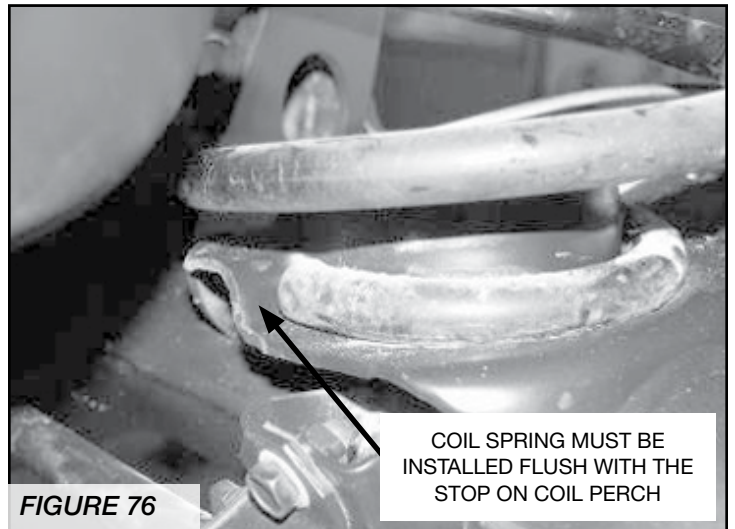
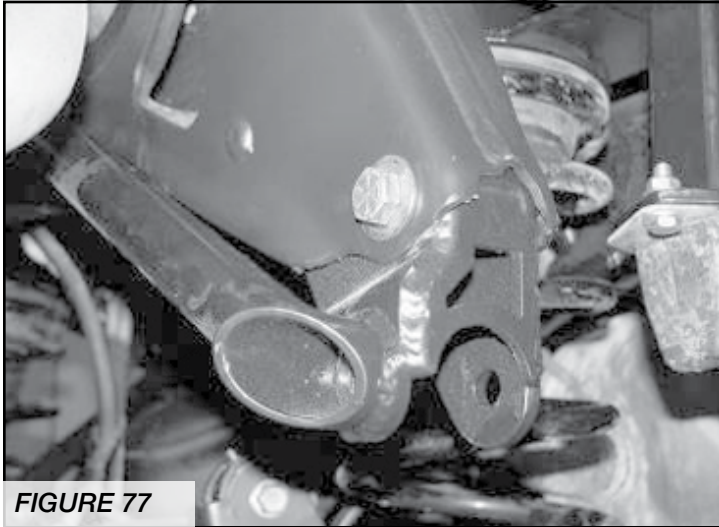


FIGURE 76

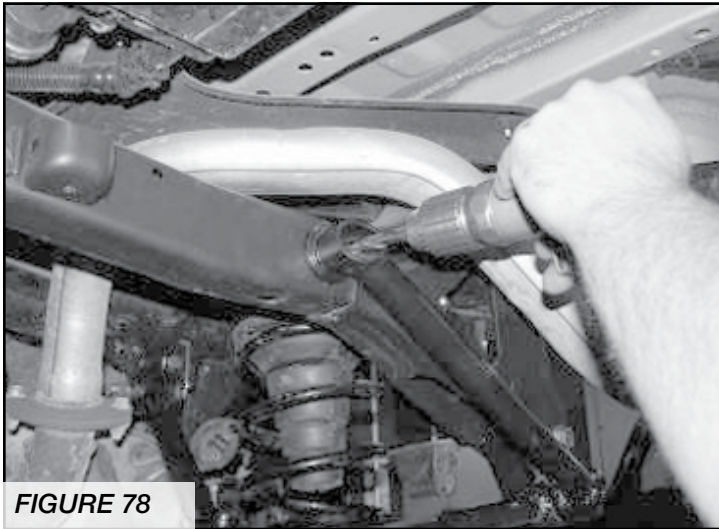
COIL SPRING MUST BE  
INSTALLED FLUSH WITH THE  
STOP ON COIL PERCH

51. Locate FT70088 Trac Bar Bracket and install into the factory trac bar mount on the frame with the supplied 9/16" hardware. Rotate the new bracket so that the support tube mount makes contact with the rear crossmember. Using a drill with a 1/2" bit, drill the new hole into the crossmember. Locate FT70096 Trac Bar Nut Tab and insert into the bottom of the crossmember just behind the new bracket and attach with the supplied 1/2"x 1 1/2" bolt, flat washer, and split washer. Torque the 1/2" hardware to 75 lbs and the 9/16" to 95 lbs. Locate and install the factory trac bar and hardware. Torque to 75 lbs.

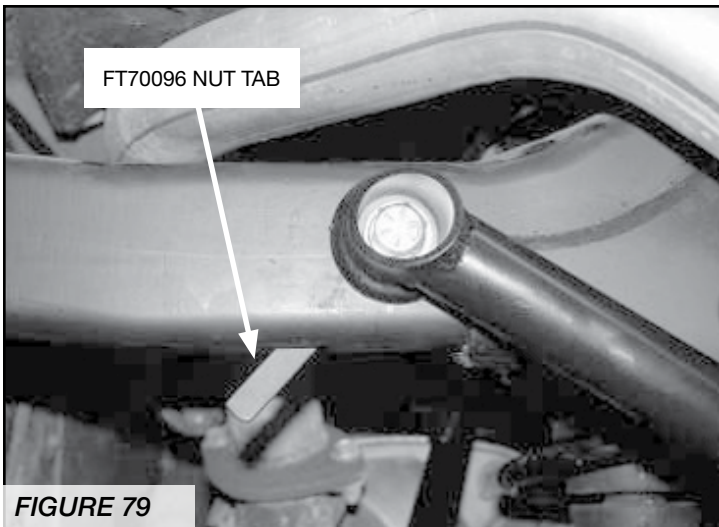
**SEE FIGURES 77-80**



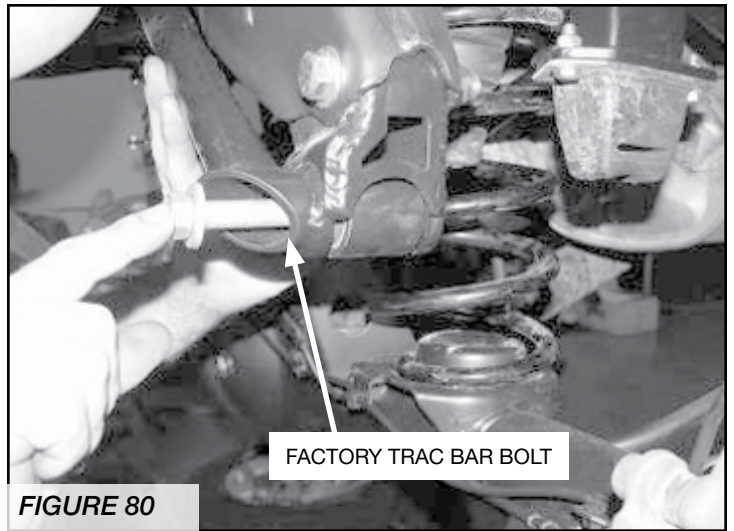
**FIGURE 77**



**FIGURE 78**



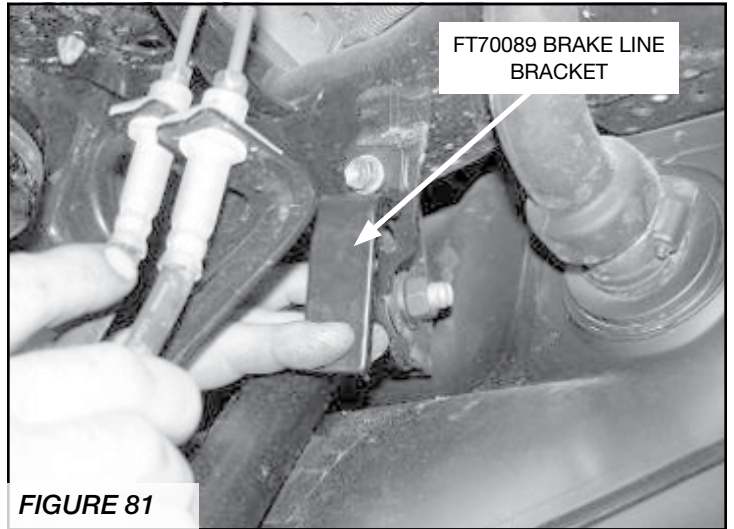
**FIGURE 79**



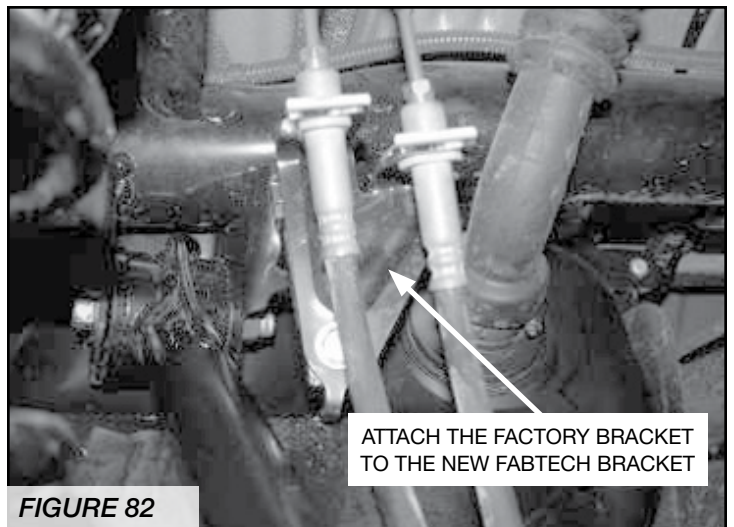
**FIGURE 80**

52. Locate FT70089 Brake Line Bracket and the supplied 5/16 x 3/4" hardware. Position the new bracket onto the factory brake line bracket on the driver's side on the crossmember and attach with the factory hardware. Use the 5/16 to attach the brake line bracket to the new Fabtech bracket. Torque the hardware to 15 lbs.

**SEE FIGURES 81-82**



**FIGURE 81**



**FIGURE 82**

53. Re-connect the ABS sensor to the harness. Locate the ABS bracket on the crossmember and carefully bend the bracket down (do not over bend, it could brake the bracket) just enough so it lines up with the clamp on the ABS lines. Check to ensure that there will be enough slack for the cables during suspension cycling. Attach the ABS clamp to the bracket with the factory hardware. **SEE FIGURES 83-85**

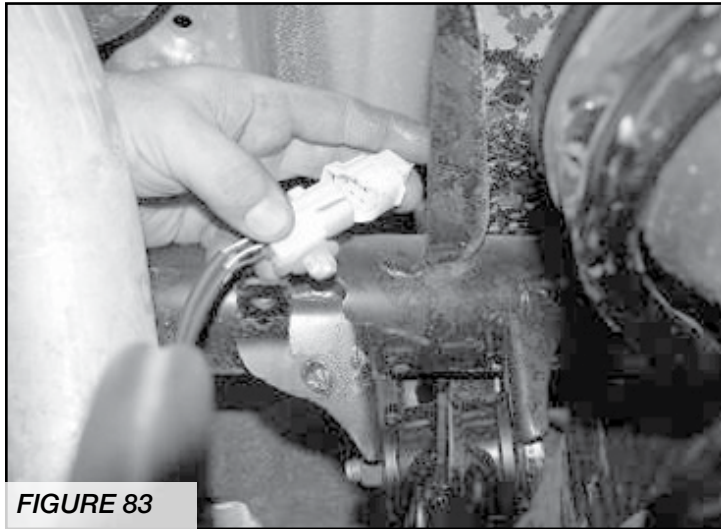


FIGURE 83

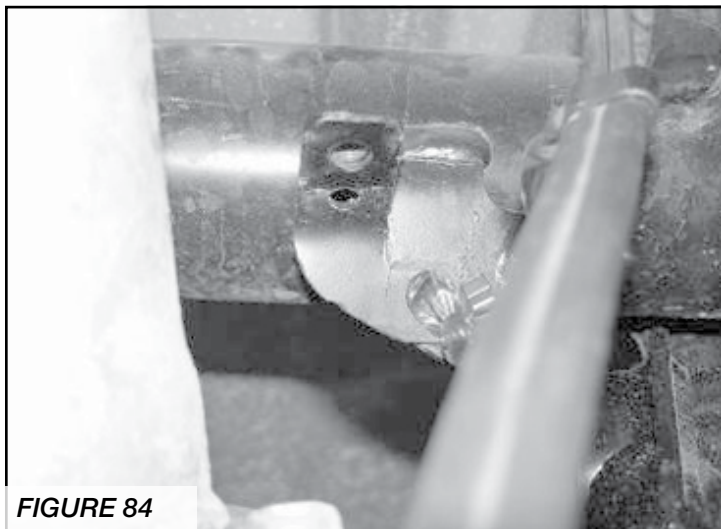


FIGURE 84

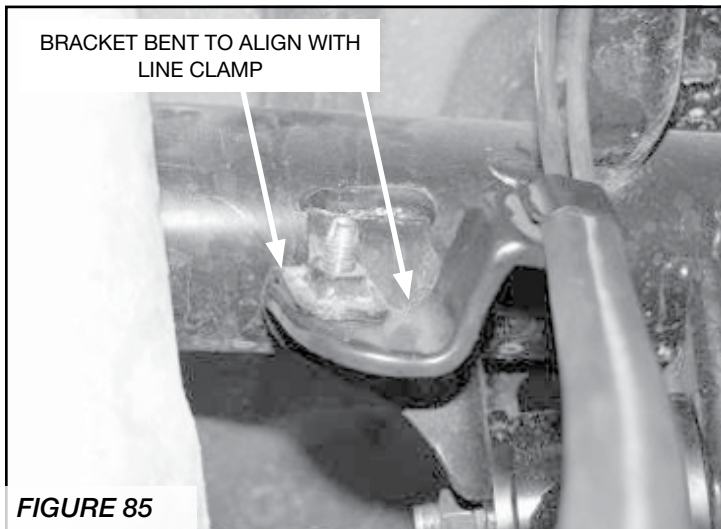


FIGURE 85

54. Attach the factory e-brake cable bracket with the supplied 5/16" hardware to the mounts on the new lower links. Torque to 15 lbs. **SEE FIGURE 86**

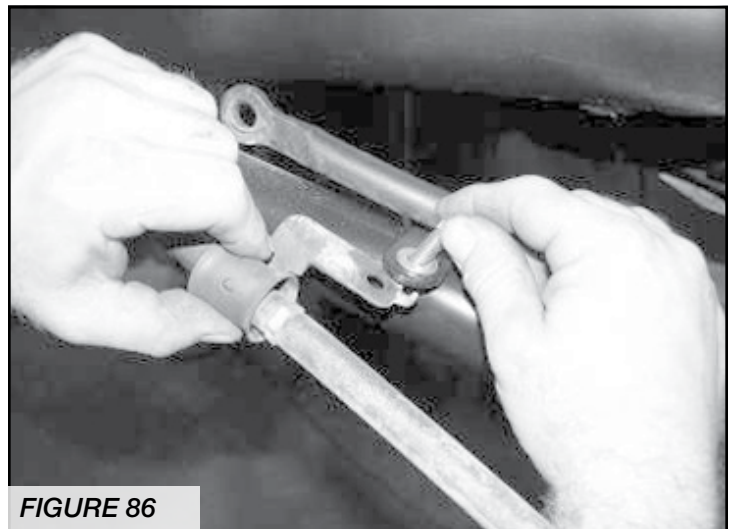


FIGURE 86

55. Locate FT70090 Sway Bar End Links and FT50116 Bushing Kit. Using an arbor press, press an hourglass bushing and sleeve into the barrel end of the links. Install a cup washer and flat bushing on the stem of the end link and install into the mount on the frame. Place the other bushing and cup washer and supplied 3/8" fine thread nut on the top of the link and leave loose. **SEE FIGURE 87**

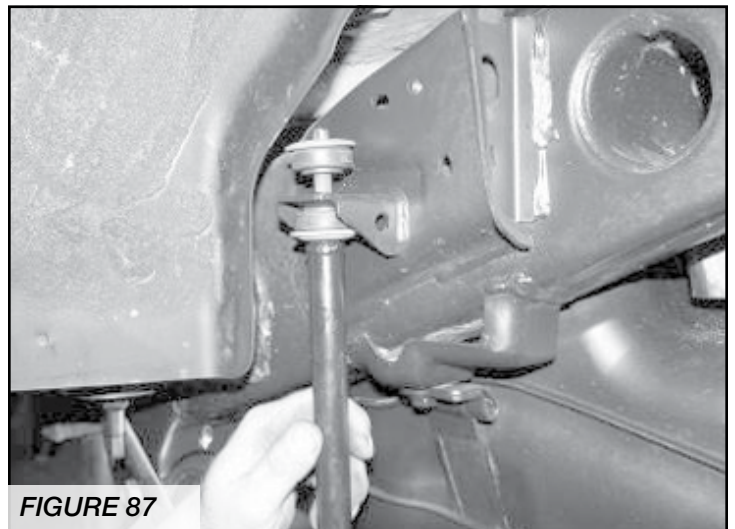
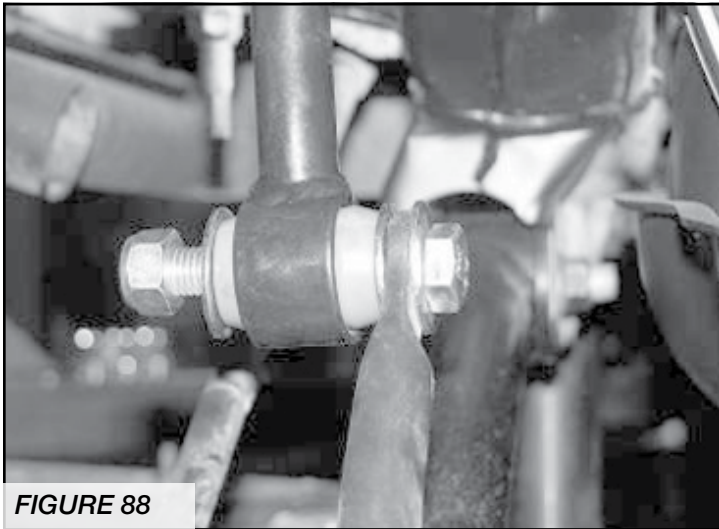


FIGURE 87

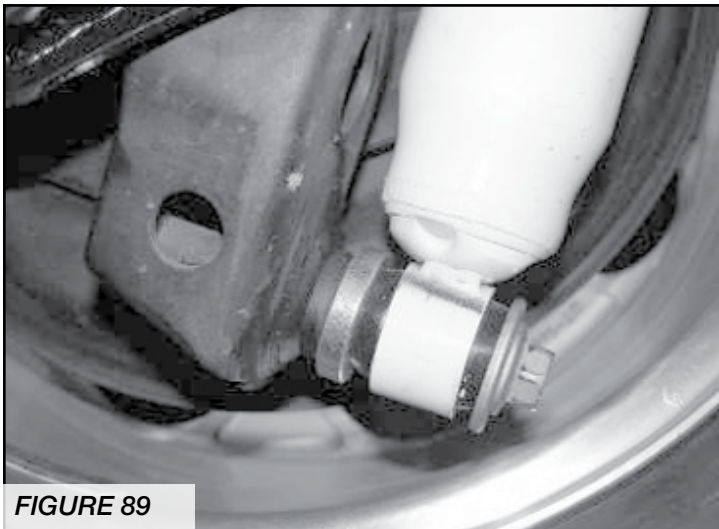
56. Locate the supplied 12mm bolt, nut, and large washers.

Place a washer onto the bolt and insert into the sway bar from the inside of the bar. Follow with another large washer. Mount the bar to link and follow with another large washer and the C-lock nut. Tighten the lower bolt first and then the upper nut. Only tighten enough to get the bushings to bulge. **SEE FIGURE 88**



**FIGURE 88**

57. Install the new Fabtech shocks FTS7237 (not included with the kit) and FT83239 Shock Spacer with the factory hardware and supplied shock sleeve. Install the spacer onto the lower shock mount and follow with the shock and factory hardware. Torque upper and lower bolts to 53lbs. **SEE FIGURE 89**



**FIGURE 89**

58. Tighten upper & lower link arms to 100 ft-lbs.
59. Install tires and wheels and torque lug nuts to wheel manufacturer's specifications. Turn front tires left to right and check for appropriate tire clearance. **Note - Some oversized tires may require trimming of the front bumper & valance.**
60. Check front end alignment and set to factory specifications. Readjust headlights.
61. Recheck all bolts for proper torque.

62. Recheck brake hoses, ABS wires and suspension parts for proper tire clearance while turning tires fully left to right.
63. Check the fluid in the front and rear differential and fill if needed with factory specification differential oil. **Note - some differentials may expel fluid after filling and driving. This can be normal in resetting the fluid level with the new position of the differential/s.**
64. Install Driver Warning Decal. Complete product registration card and mail to Fabtech in order to receive future safety and technical bulletins on this suspension

**Vehicles that will receive oversized tires should check ball joints and all steering components every 2500-5000 miles for wear and replace as required.**

**RETORQUE ALL NUTS, BOLTS AND LUGS AFTER 50 MILES AND PERIODICALLY THEREAFTER.**

For technical assistance call: 909-597-7800

## - Product Warranty and Warnings -

Fabtech provides a Limited Lifetime Warranty to the original retail purchaser who owns the vehicle, on which the product was originally installed, for defects in workmanship and materials.

The Limited Lifetime Warranty excludes the following Fabtech items; bushings, bump stops, ball joints, tie rod ends, limiting straps, cross shafts, heim joints and driveshafts. These parts are subject to wear and are not considered defective when worn. They are warranted for 60 days from the date of purchase for defects in workmanship.

Dirt Logic and Performance Coilover take apart shocks are considered a serviceable shock with a one year warranty on leakage only. Service seal kits are available separately for future maintenance. All other shocks are covered under our Limited Lifetime Warranty.

Fabtech does not warrant any product for finish, alterations, modifications and/or installation contrary to Fabtech's instructions. Alterations to the finish of the parts including but not limited to painting, powder coating, plating and/or welding will void all warranties. Some finish damage may occur to parts during shipping, which is considered normal and is not covered under warranty.

Fabtech products are not designed nor intended to be installed on vehicles used in race applications or for racing purposes or for similar activities. (A "RACE" is defined as any contest between two or more vehicles, or any contest of one or more vehicle against the clock, whether or not such contest is for a prize). This warranty does not include coverage for police or taxi vehicles, race vehicles, or vehicles used for government or commercial purposes. Also excluded from this warranty are sales outside of the United States of America.

Installation of most suspension products will raise the center of gravity of the vehicle and will cause the vehicle to handle differently than stock. It may increase the vehicle's susceptibility to a rollover, on road and off road, at all speeds. Extreme care should be taken to operate the vehicle safely at all times to prevent rollover or loss of control resulting in serious injury or death. Fabtech front end Desert Guards may impair the deployment or operation of vehicles equipped with supplemental restraining systems/air bag systems and should not be installed if the vehicle is equipped as so.

Fabtech makes every effort to ensure suspension product compatibility with all vehicles listed on the website, but due to unknown auto manufacturer's production changes and/or inconsistencies by the auto manufacturer, Fabtech cannot be responsible for 100% compatibility, including the fitment of tire and wheel sizes listed. The Tire and Wheel sizes listed in Fabtech's website are only a guideline for street driving with noted fender trimming. Fabtech is not responsible for damages to the vehicle's body or tires. Fabtech is not responsible for premature wear of factory components due to the installation of oversized tires and wheels.

Fabtech's obligation under this warranty is limited to the repair or replacement, at Fabtech option, of the defective product only. All costs of removal, installation or re-installation, freight charges, incidental or consequential damages are expressly excluded from this warranty. Fabtech is not responsible for damages and/or warranty of other vehicle parts related or non related to the installed Fabtech product. This warranty is expressly in lieu of all other warranties expressed or implied. This warranty shall not apply to any product that has been subject to accident, negligence, alteration, abuse or misuse as determined by Fabtech.

Fabtech suspension components must be installed as a complete system including shocks as shown on our website. All warranties will become void if Fabtech parts are combined and/or substituted with other aftermarket suspension products. Combination and/or substitution of other aftermarket suspension parts may cause premature wear and/or product failure resulting in an accident causing injury or death. Fabtech does not warrant products not manufactured by Fabtech.

Depending on the condition of the factory suspension components retained after the installation of a Fabtech suspension not all vehicles may have the same ride stance front to rear as described in the website. The blue color of suspension components shown in all Fabtech photographs are for display purposes only. Majority of all Fabtech components will be black specifically where noted with part numbers ending in BK.

Installation of Fabtech product may void the vehicles factory warranty; it is the consumer's responsibility to check with their local vehicle's dealer for warranty disposition before the installation of the product. Some state laws may prohibit modification of suspension to a vehicle in whole or in part. It is the responsibility of the installer and consumer to consult local laws prior to the installation of any Fabtech suspension product to comply with such written laws.

It is the responsibility of the distributor and/or the retailer to review all warranties and warnings of Fabtech products with the consumer prior to purchase.

Fabtech reserves the right to super cede, discontinue, change the design, finish, part number and/or application of parts when deemed necessary without written notice. Fabtech is not responsible for misprints or typographical errors within the website or price sheet. For the most recent Product Warranty and Warnings visit our website [www.fabtechmotorsports.com](http://www.fabtechmotorsports.com)