



## INSTALLATION INSTRUCTIONS



## 2019-2020 DODGE RAM 1500 4WD

### 6" BASIC & PERFORMANCE SYSTEMS

**FTS23200**

**NOTE:** TO ORDER WEARABLE REPLACEMENT COMPONENTS DO NOT USE PART NUMBERS SHOWN ON THIS INSTRUCTION SHEET. GO TO FABTECH WEBSITE AND LOOK UP WEARABLE REPLACEMENT PARTS TO FIND THE PROPER PART NUMBER TO ORDER.

**Fabtech Motorsports** | 4331 Eucalyptus Ave. Chino, CA 91710

**Tech Line:** 909-597-7800 | **Fax:** 909-597-7185 | **Web:** [www.fabtechmotorsports.com](http://www.fabtechmotorsports.com)

<b>FTS23200 COMPONENT BOX 1</b>		
1	FT44020	DIFF MOUNT FRONT (PASS)
1	FT44021	DIFF MOUNT (DRIVER)
1	FT44026	DIFF MOUNT (REAR PASS)
2	FT44163BK	REAR UPPER LINK
2	FT44164BK	REAR LOWER LINK
1	FT44204	DIFF MOUNT REAR
1	FT44207	PASS MOUNT INNER
2	FT44288	TIE ROD END
1	FT44467D	6" KNUCKLE (DRIVER)
1	FT44467P	6" KNUCKLE (PASS)
1	FT44469	HARDWARE SUBASSEMBLY
1	FT44486	SWAY BAR DROP BRACKET (DRIVER)
1	FT44487	SWAY BAR DROP BRACKET (PASS)

<b>FT44469 HARDWARE SUBASSEMBLY</b>		
1	FT23200i	INSTRUCTIONS
2	FT20664	AXLE SPACER
1	FT44494	HARDWARE KIT
2	FT44205	SLEEVE 1.000 X .563 X .665 (NON DIESEL)
1	FT44472	BRAKE LINE BRACKET (DRIVER)
1	FT44473	BRAKE LINE BRACKET (PASS)
2	FT50232	SLEEVE 1.000 X .531 X .450 (DIESEL)
2	FT90111	BUSHING KIT
1	FTAS12	STICKER FT BLUE 10X4 DIE CUT
1	FTAS16	DRIVER WARNING DECAL
1	FTREGCARD	REGISTRATION CARD
1	FT44543	REAR BRAKE LINE BRACKET (2020 Models only)

<b>FTS23201 COMPONENT BOX 2</b>		
2	FT1599-2-4	5" SWAY BAR LINK
1	FT44188BK	REAR BUMPSTOP SPACER (DRIVER)
1	FT44189BK	REAR BUMPSTOP SPACER (PASS)
1	FT44203	DRIVE SHAFT SPACER
1	FT44357BK	SKID PLATE
1	FT44474	TRACK BAR DROP BRACKET
1	FT44475	REAR COIL SPACER (DRIVER)
1	FT44476	REAR COIL SPACER (PASS)
1	FT44477	FRONT CROSSMEMBER
1	FT44478	REAR CROSSMEMBER
1	FT44493	HARDWARE SUBASSEMBLY

<b>FT44493 HARDWARE SUBASSEMBLY</b>		
8	FT1004	SWAY BAR LINK BUSHING HALF
2	FT44045	TRACK BAR NUT TAB
4	FT404739	SLEEVE 0.62 OD X 12MM ID X 1.48 L

<b>FTS23038 SPACER KIT</b>		
2	FT44209BK	6" SHOCK SPACER

<b>FT44494 - HARDWARE KIT</b>		<b>LOCATION</b>
<b>BAG 1</b>		
3	M12-1.75 X 35MM HEX BOLT	
4	M12-1.75 X 55MM HEX BOLT	
7	M12 FLAT WASHER	
7	M12 SPLIT LOCK WASHER	
3	1/2-13 X 1-1/4 HEX BOLT	
2	1/2-13 X 2-3/4 HEX BOLT	
22	1/2 SAE WASHER	
8	1/2-13 C-LOCK NUT	
2	1/2-13 X 2-1/4 HEX BOLT	
2	THREAD LOCKING COMPOUND	
<b>BAG 2</b>		
4	5/8-11 X 5-1/2 HEX BOLT	
8	5/8" SAE WASHER	
4	5/8-11 C-LOCK NUT	
2	1/2-13 X 1-1/4 HEX BOLT	
4	1/2" SAE WASHER	
2	1/2-13 C-LOCK NUT	
10	7/16-14 C-LOCK NUT	
14	7/16" SAE WASHER	
4	7/16-14 X 1-1/4 HEX BOLT	
2	5/16-18 X 1" SELF TAPPING BOLT	
5	1/4-20 X 3/4" HEX BOLT	
8	1/4" SAE WASHER	
3	1/4-20 NYLOCK NUT	
2	CLAMP	
6	8" ZIP TIE	
<b>BAG 3</b>		
6	1/2-13 X 1-1/2 HEX BOLT	
11	1/2" SAE WASHER	
5	1/2-13 C-LOCK NUT	
6	3/8-16 C-LOCK NUT	
6	3/8" SAE WASHER	
1	9/16-12 X 3" HEX BOLT	
2	9/16" SAE WASHER	
1	9/16-12 C-LOCK NUT	
1	7/16-14 X 1-1/4" HEX BOLT	
1	7/16" SAE WASHER	
1	7/16" LOCK WASHER	
4	M12-1.75 X 70MM HEX BOLT	
8	M12 FLAT WASHER	
4	M12-1.75 C-LOCK NUT	
8	1/4-28 GREASE FITTING	

## - TOOL LIST -

### **Required Tools (Not Included)**

- Basic Hand Tools
- Assorted Metric and S.A.E sockets, and Allen wrenches
- Floor Jack
- Torque Wrench
- Jack Stands
- Die Grinder w/ Cutoff Wheel or Sawzall

## - PRE-INSTALLATION NOTES -

For technical assistance call: **909-597-7800** or e-mail: **info@fabtechmotorsports.com**

### **READ THIS BEFORE YOU BEGIN INSTALLATION -**

Check all parts to the parts list above before beginning installation. If any parts are missing contact Fabtech at 909-597-7800 and a replacement part will be sent to you immediately.

Read all instructions thoroughly from start to finish before beginning the installation. If these instructions are not properly followed severe frame, driveline and / or suspension damage may occur.

Check your local city and state laws prior to the installation of this system for legality. Do not install if not legal in your area.

Prior to the installation of this suspension system perform a front end alignment and record. Do not install this system if the vehicle alignment is not within factory specifications. Check for frame and suspension damage prior to installation.

The installation of this suspension system should be performed by two professional mechanics.

This suspension must be installed with Fabtech shock absorbers.

Use the provided thread locking compound on all hardware.

**WARNING-** Installation of this system will alter the center of gravity of the vehicle and may increase roll over as compared to stock.

Vehicles that receive oversized tires should check ball joints, uniballs, tie rods ends, pitman arm and idler arm every 2500-5000 miles for wear and replace as needed.

Verify differential fluid is at manufactures recommended level prior to kit installation. Installation of the kit will reposition the differential and the fill plug hole may be in a different position. (For example, if the manufacture recommends 3 quarts of fluid, make sure the diff has 3 quarts of fluid). Check your specific manual for correct amount of fluid.

### **FOOTNOTES:**

- Can not use OEM wheel and tire
- Will not fit factory air suspension vehicles
- Must use aftermarket 20" wheels or larger
- Does not fit vehicles equipped with OEM 22" wheel & heavy duty bearing option
- Does not fit Rebel models
- Does not fit 2019 Ram 1500 classic models
- Will not fit diesel models

### **Recommend Tires and Wheels:**

Use 35/12.50R20 tire w/ 20x9 wheels w/ 5" BS w/ minor trimming

Use 37/12.50R20 tire w/ 20x9 wheels w/ 5" BS w/ minor trimming

# - INSTRUCTIONS -

## FRONT SUSPENSION

1. Disconnect the negative terminal on the battery. Jack up the front end of the truck and support the frame rails with jack stands. **NEVER WORK UNDER AN UNSUPPORTED VEHICLE!** Remove the front tires.
2. Remove the factory transfer case skid plate and discard.
3. Disconnect the front drive shaft from the differential and discard the hardware. (Do not allow it to hang freely) **SEE FIGURE 1**



FIGURE 1 - STEP 3

4. Locate the sway bar and sway bar end links. Disconnect the end links from the lower control arms. Then, remove the sway bar from the frame and save hardware.
5. Working from the driver side of the vehicle, disconnect the tie rod end from the steering knuckle by striking the knuckle to dislodge the tie rod end. **SEE FIGURE 2**

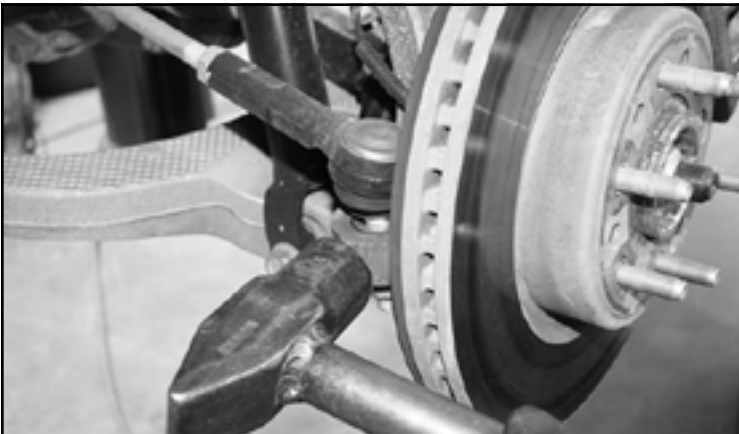

FIGURE 2 - STEP 5

6. Remove the axle nut from the center of the hub and save. **SEE FIGURE 3**



FIGURE 3 - STEP 6

7. Remove the brake line bracket bolt from the frame coilover perch. Save hardware. **SEE FIGURE 4**

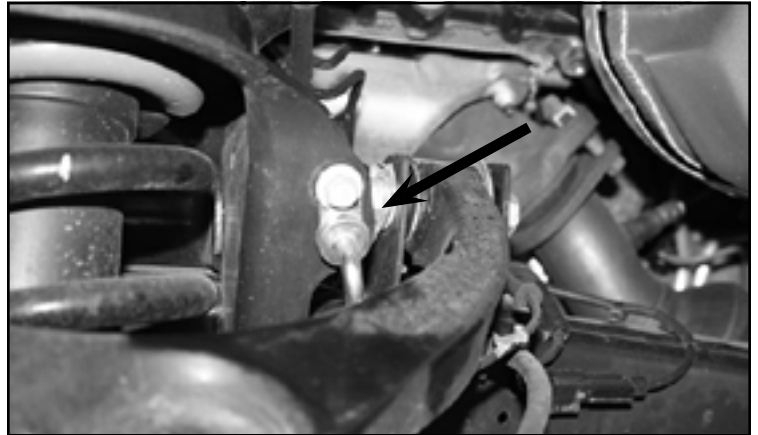

FIGURE 4 - STEP 7

8. Remove the brake caliper and secure it to the frame. Do not overstretch the brake hose when doing so. **DO NOT LET THE BRAKE CALIPER HANG FROM THE BRAKE HOSE.** Retain the hardware for reinstallation. Remove the brake rotor and save. Unplug the ABS wire at the plug behind the inner fender well and remove the ABS line clamp where it is attached to the steering knuckle. **SEE FIGURE 5-8**



FIGURE 5 - STEP 8



FIGURE 6 - STEP 8



FIGURE 7 - STEP 8

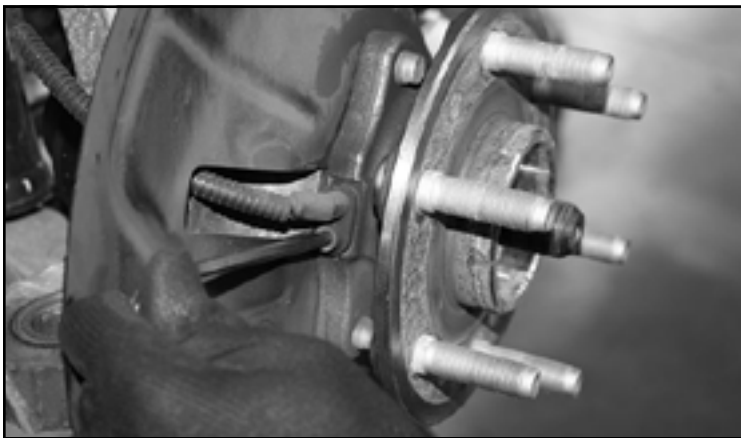

FIGURE 8 - STEP 8

9. Remove the upper and lower ball joint nuts and save. Using a large hammer, strike the steering knuckle to dislodge the ball joints from the steering knuckle. USE CARE NOT TO DAMAGE THE THREADS ON THE BALL JOINTS. Remove the steering knuckle from the truck. **SEE FIGURES 9-11**



FIGURE 9 - STEP 9



FIGURE 10 - STEP 9



FIGURE 11 - STEP 9

10. Remove the three upper shock assembly bolts from the truck and save. Remove the lower shock bolt and save. Remove the shock assembly from the truck and save. The factory shock assembly will be reused if you are installing the 6" Basic System. If you are installing the 6" Performance System, you can discard the factory shock assembly and hardware. **SEE FIGURE 12**



**FIGURE 12 - STEP 10**

11. Remove the factory lower control arm bolts / alignment cams and save. Remove the lower control arm and save. **SEE FIGURE 13**



**FIGURE 13 - STEP 11**

12. Using a cutoff wheel. Mark and cut the factory brake line bracket on the upper coilover mount like shown in **FIGURE 14-15**



**FIGURE 14 - STEP 12**



**FIGURE 15 - STEP 12**

13. Repeat steps 5-12 on the passenger side.

14. Remove the factory rear crossmember from the vehicle and discard. **SEE FIGURE 16**



**FIGURE 16 - STEP 14**



15. Locate the driver side rear lower control arm mount where the factory rear crossmember was previously removed. As shown in the picture below, measure 1" from the factory cam bolt tab and mark a straight vertical line then cut. **SEE FIGURE 17.**

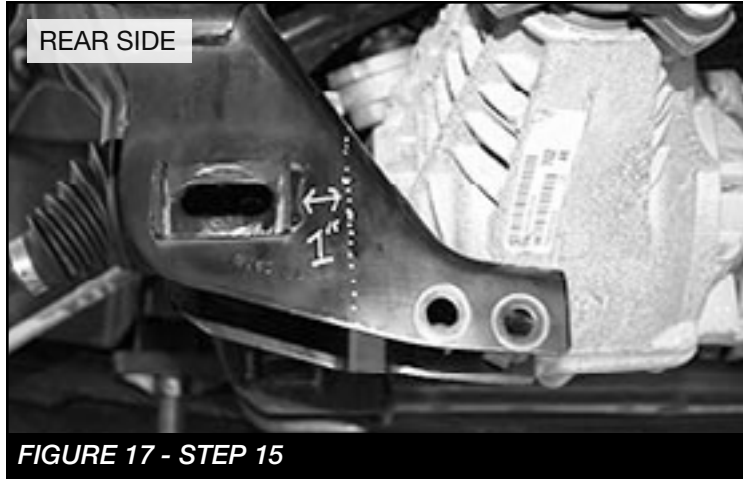

16. On the same mount, measure 1/2" from the bottom corner and mark a straight horizontal line and cut. **SEE FIGURE 18**

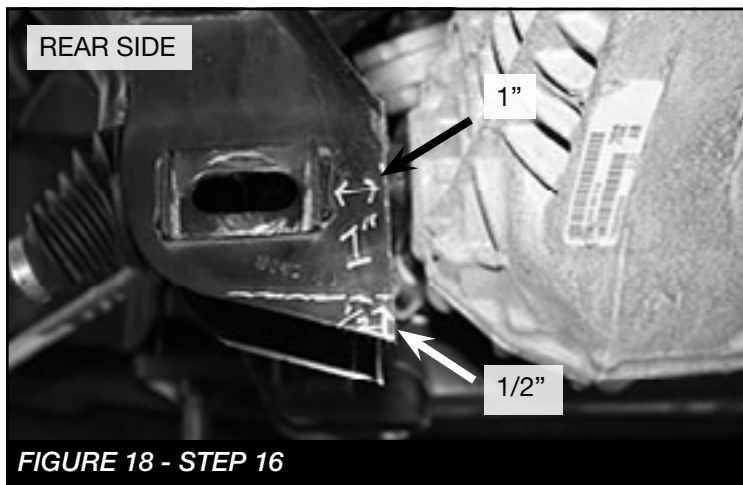

DUE TO VARIANCES IN EACH TRUCK, ADDITIONAL CUTTING / GRINDING MAY BE REQUIRED FOR PROPER FITTING OF THE CROSSMEMBERS AND DIFFERENTIAL. USE THESE MEASUREMENTS AS A STARTING POINT AND CLEARANCE THE FRAME POCKETS AS NEEDED FOR PROPER FITTING OF THE CROSSMEMBERS & DIFFERENTIAL.

17. Repeat steps 15-16 on the front side of the driver rear pocket. **SEE FIGURES 19-20**



18. Repeat steps 15-17 on the passenger side rear control arm pocket.
19. Support the differential with a floor jack or transmission jack, disconnect solenoid and remove the differential from the truck. Save the hardware some will be re-used. **SEE FIGURES 21-24**



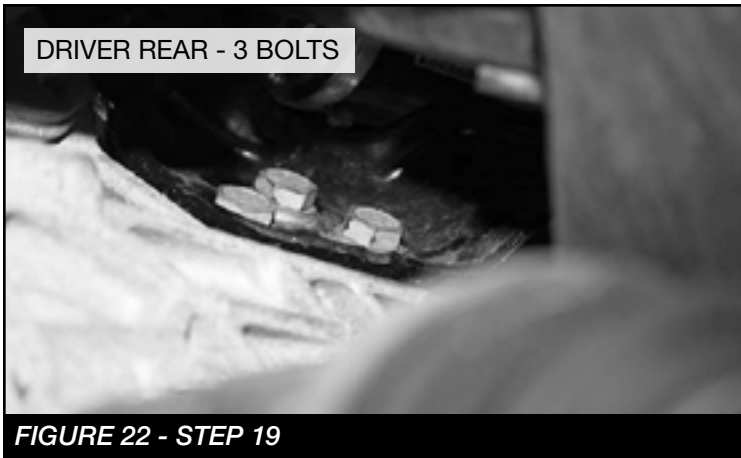

FIGURE 22 - STEP 19

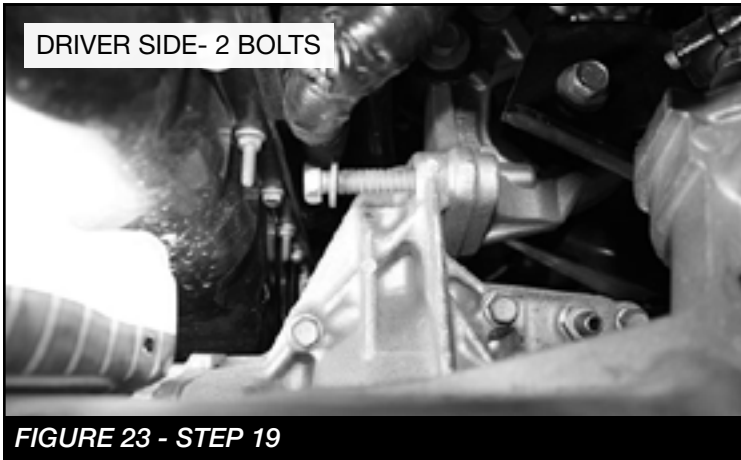

FIGURE 23 - STEP 19

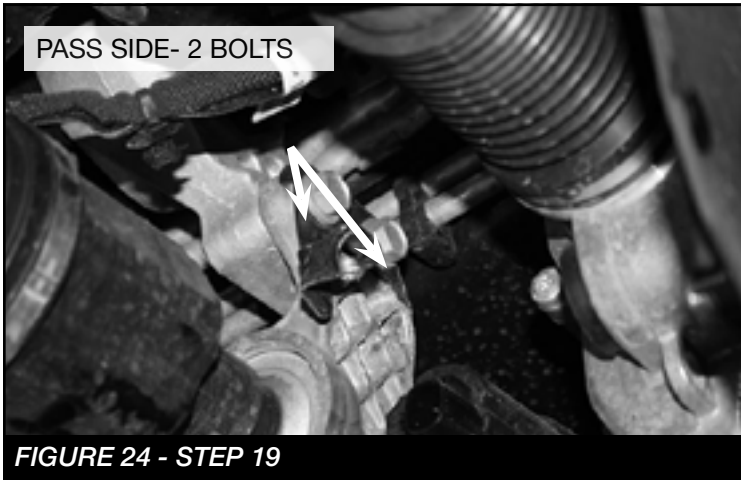

FIGURE 24 - STEP 19

- Use **FIGURE 25** as a reference for the following steps.

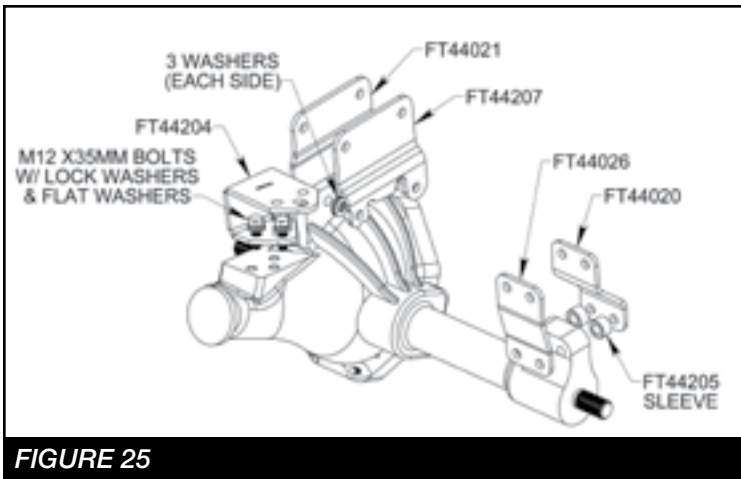
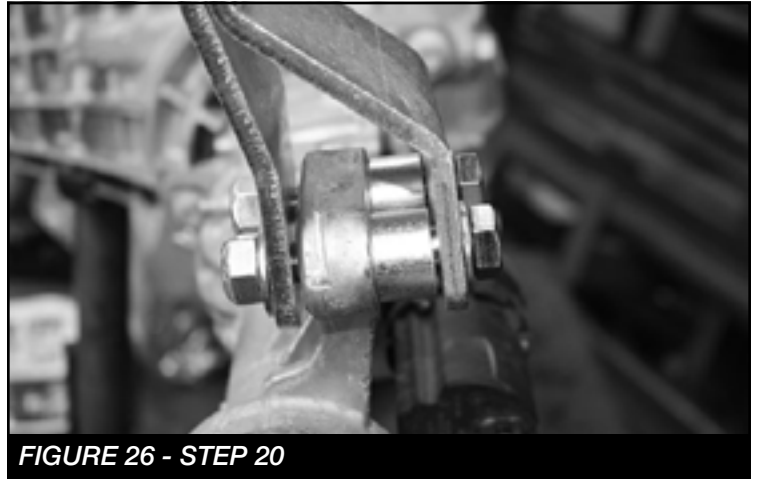

FIGURE 25

20. Locate FT44020 and FT44026 passenger side differential mounts. Using the supplied 1/2" x 2 3/4" hardware attach the brackets to the differential using **(FOR GAS ENGINES)** FT44205 (1.000 X .563 X .665-larger spacer). The spacers will provide space between the FT44020 bracket and the differential. Torque to 106 ft-lbs. **SEE FIGURE 26**





21. Locate FT44204 (Driver rear diff mount). Using the M12x35mm bolts, lock washers and flat washers attach the bracket to the original diff mount. Torque to 93 ft-lbs. **SEE FIGURES 27**



**FIGURE 27 - STEP 21**

22. Locate FT44021, FT44207 Driver front diff mounts and (10) 1/2" SAE Washers. Using the supplied 1/2" X 2-1/4" hardware attach the brackets to the differential as shown in the diagram. Leave loose at this time. **SEE FIGURES 28-30**

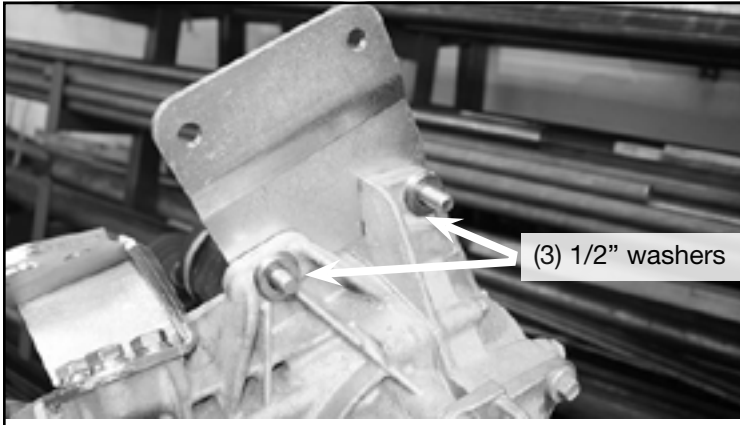

**FIGURE 28 - STEP 22**



**FIGURE 29 - STEP 22**

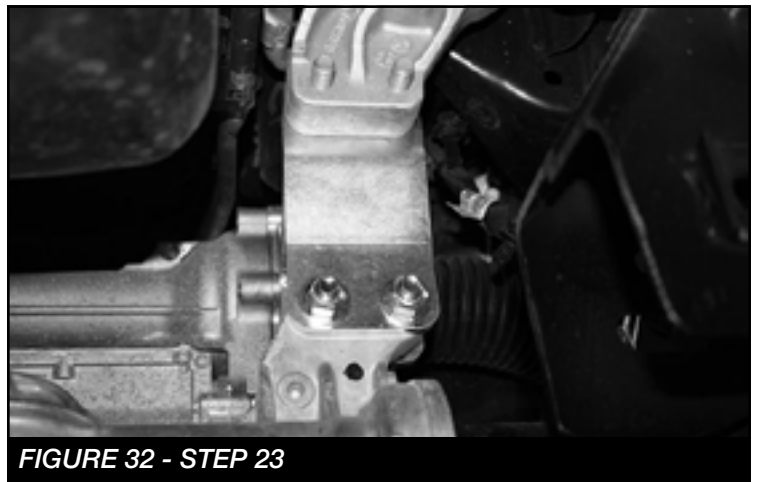

**FIGURE 30 - STEP 22**

23. Install the differential back into the truck attaching the new Fabtech drop brackets to the factory frame mounts. Use the factory hardware on the passenger side & driver front brackets. Use the supplied 1/2 -13 x 1-1/4" bolt, nuts, and washer on the driver rear brackets. **LEAVE ALL HARDWARE LOOSE AT THIS TIME. SEE FIGURES 31-33**



**FIGURE 31 - STEP 23**



**FIGURE 32 - STEP 23**



**FIGURE 33 - STEP 23**

24. Reconnect the solenoid. **SEE FIGURE 34**



**FIGURE 34 - STEP 24**

25. Locate FT44477 (front crossmember) and install it into the front lower control arm pockets using the supplied 5/8" x 5 1/2" bolts, nuts, and washers. Leave loose at this time. **SEE FIGURE 35**



**FIGURE 35 - STEP 25**

26. Locate FT44478 (rear crossmember) and install it into the frame pockets using the 5/8" x 5 1/2" bolts, nuts, and washers. Leave loose at this time. **SEE FIGURE 36**



**FIGURE 36 - STEP 26**

27. Locate FT44357BK (skid plate) and attach to the crossmembers using the supplied 1/2" X 1-1/4" bolts, nuts, and washers, Torque to 106 ft-lbs. **SEE FIGURE 37**

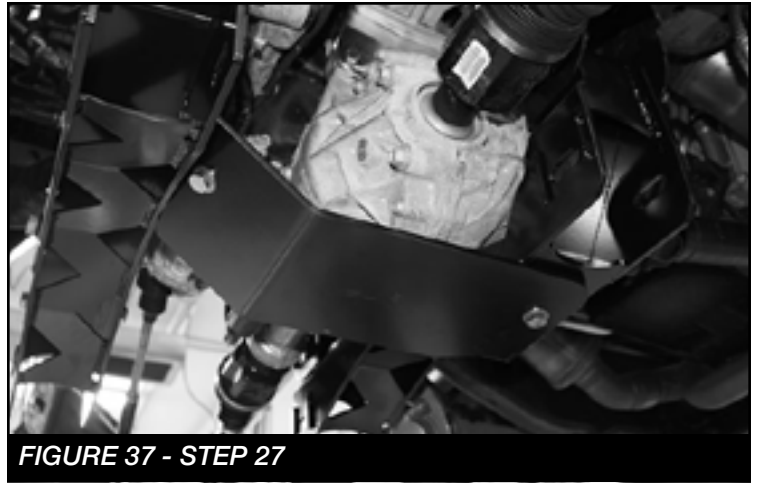

**FIGURE 37 - STEP 27**

28. Install the factory lower control arms to the Fabtech crossmembers using the original alignment cam bolts. Leave loose at this time. Torque the upper crossmember bolt to 210 ft-lbs. **SEE FIGURE 38**

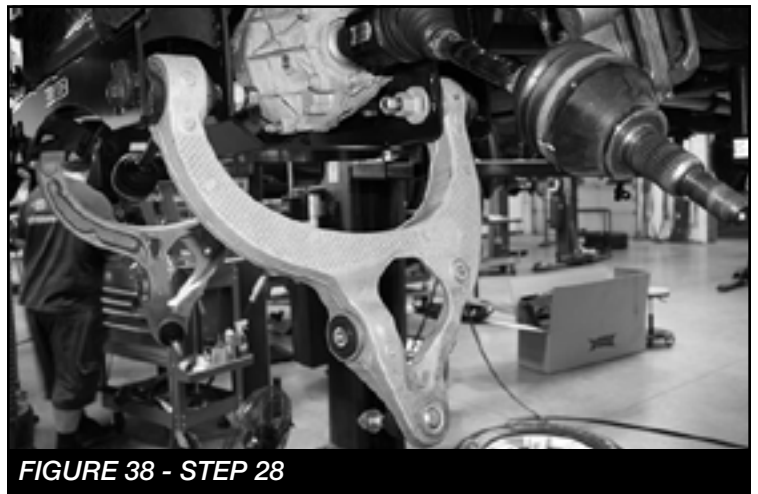

**FIGURE 38 - STEP 28**

**FOLLOW STEPS 29-30 FOR BASIC KIT ONLY.  
IF INSTALLING THE PERFORMANCE SYSTEM  
WITH DIRT LOGIC 2.5 COILOVERS, INSTALL THE  
COILOVER SO IT IS OFFSET AWAY FROM THE  
AXLE.**

29. Locate the previously removed shock assembly and attach FT44209BK spacer to the top of the shock assembly using the stock hardware. Torque to 35 ft-lbs. You will need to mount the spacer so that it aligns properly with the coilover. **SEE FIGURE 39**



**FIGURE 39 - STEP 29**

30. Install the complete shock assembly into the truck attaching the three upper bolts first using the supplied 7/16" C-lock and flat washers, leave loose. Torque upper hardware to 83 ft. lbs. **SEE FIGURE 40** Repeat on passenger side.

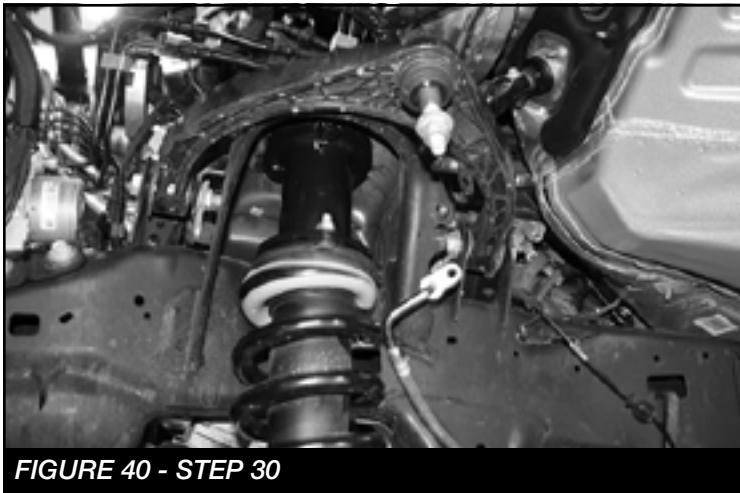

**FIGURE 40 - STEP 30**

31. Locate the factory knuckles and remove the hub bearing and heat shield from both of them. Save hardware. **SEE FIGURES 41-42**



**FIGURE 41 - STEP 31**



**FIGURE 42 - STEP 31**

32. Locate FT44467D & FT44467P, install the hub bearing and heat shield onto each of them in the same manner as they were installed on the factory knuckles. **SEE FIGURE 43**



**FIGURE 43 - STEP 32**

33. Install the new knuckle by installing it to the lower ball joint first. **NOTE: Install FT20664 (Axle spacer) onto the axle shaft while you are installing the axle shaft through the knuckle hub.** Then attach the upper control arm ball joint. Torque the upper and lower ball joint nuts to 47 ft-lbs. **SEE FIGURES 44-45**



**FIGURE 44 - STEP 33**



**FIGURE 45 - STEP 33**

34. Install the center hub nut. Torque to 185 ft-lbs. Torque the lower crossmember cam bolts to 210 ft-lbs. **SEE FIGURE 46**

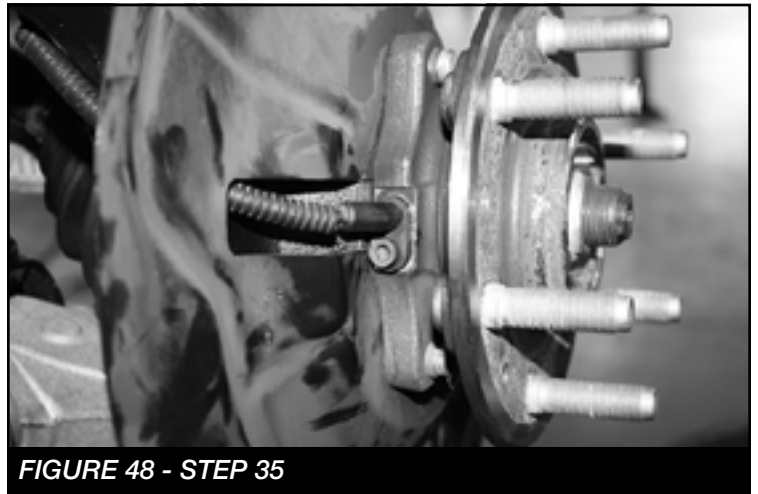

**FIGURE 46 - STEP 34**

35. Install ABS line to the back of the knuckle using the supplied adel clamp, and 1/4" x 3/4" hardware. Reinstall the sensor to the hub using the factory bolt. **SEE FIGURES 47-48** Torque to 10 ft-lbs.



**FIGURE 47 - STEP 35**



**FIGURE 48 - STEP 35**

36. Repeat steps 33-35 on the passenger side.

37. Using FT44472 (Driver brake line bracket) as a guide place onto the frame like shown in **FIGURE 49** and mark the hole to drill. Drill to 5/16" **SEE FIGURE 50**

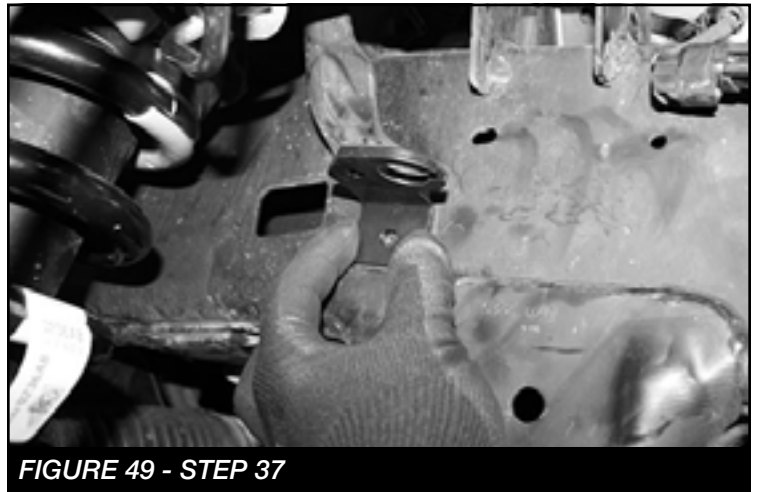

**FIGURE 49 - STEP 37**





FIGURE 50 - STEP 37

38. Install the new brakeline bracket using the supplied 5/16 x 1" self-tapping bolt. Then, install the brakeline to the new bracket using the supplied 1/4" hardware. Torque to 10 ft-lbs **SEE FIGURE 51** Use the supplied zip ties to attach the ABS line to the hydraulic brake lines. Repeat on the passenger side using FT44473 (Pass brake line bracket)



FIGURE 51 - STEP 38

39. Install FT44203 (Driveshaft spacer) between the front driveshaft and front diff using the supplied M12x 55mm bolts lock and flat washers. Torque to 97 ft-lbs. **NOTE: Some models will need to trim the plastic bracket on the side of the transmission due to contact with the driveshaft. SEE FIGURES 52-53**

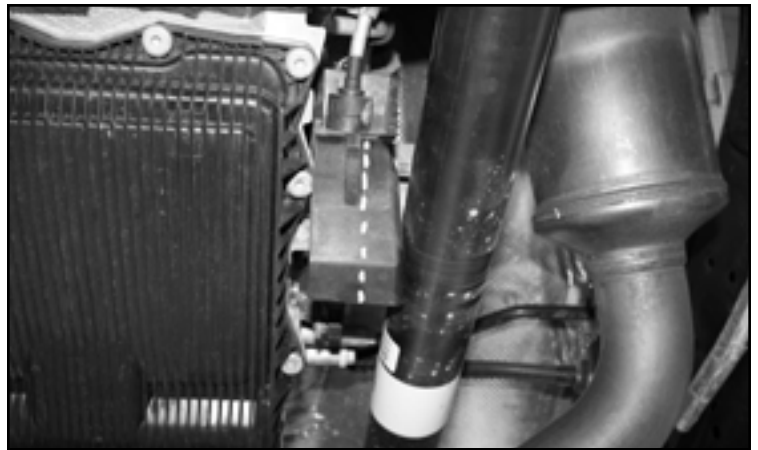

FIGURE 52 - STEP 39

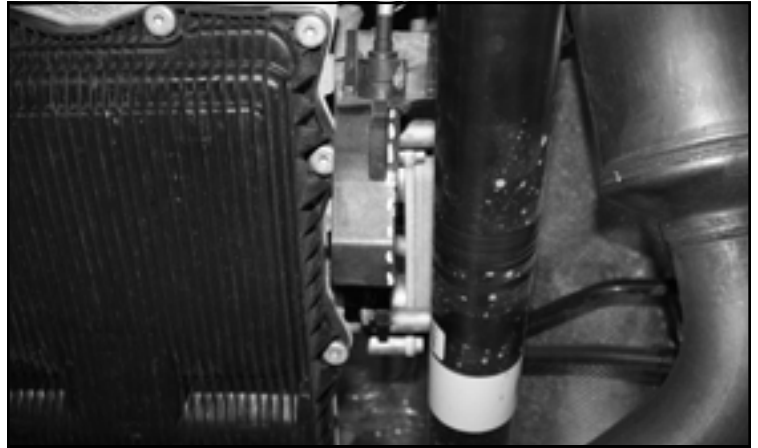

FIGURE 53 - STEP 39

40. Install FT44486 (driver sway bar drop bracket) & FT44487 (pass sway bar drop bracket) to the frame using the factory hardware. Torque to 78 ft-lbs. Then, install the factory sway bar to the new brackets using the supplied 7/16 x 1-1/4" hardware. Torque to 78 ft-lbs **SEE FIGURE 54**



FIGURE 54 - STEP 40

41. Reinstall the sway bar endlinks to the lower control arms using the factory hardware. **SEE FIGURE 55**

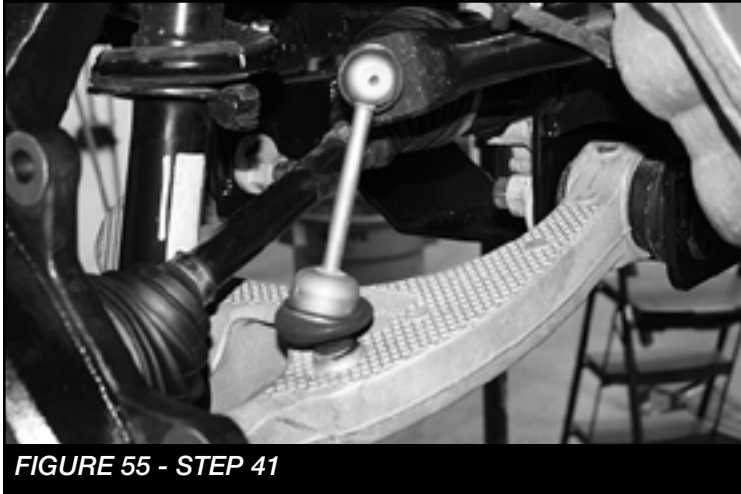
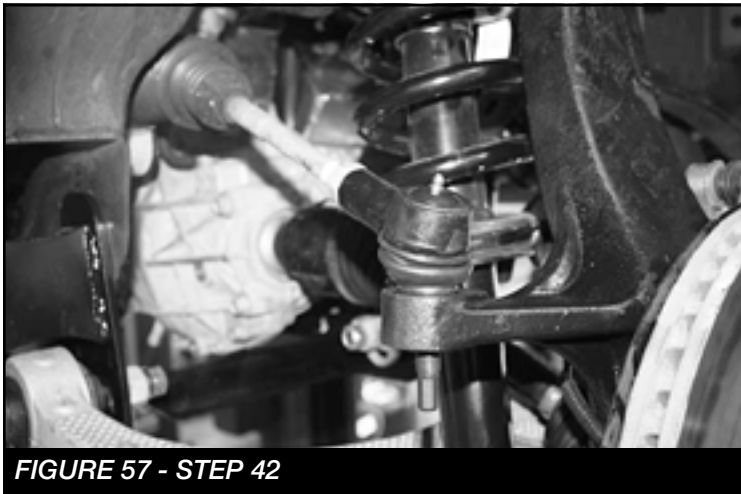

**FIGURE 55 - STEP 41**

42. Remove the factory tie rod end and install FT44288 (Tie rod end) in its place. Then, install to the knuckle. **SEE FIGURES 56-57**



**FIGURE 56 - STEP 42**



**FIGURE 57 - STEP 42**

## **REAR SUSPENSION**

43. Disconnect the rear brake line from the frame. Save hardware. **SEE FIGURE 58**



**FIGURE 58 - STEP 43**

44. Remove the inner fender wells and save all hardware.
45. Remove the factory sway bar endlinks and discard. Then Disconnect the track bar from the axle side. Save hardware.
46. With the axle supported. Remove the factory shocks, coil springs and upper link arms. Save hardware.
47. Locate FT44188BK (driver) & FT44189BK (pass) Rear Bumpstop Brackets and the supplied 7/16" x 1-1/2" hardware. Place the bump stop extension mounts onto the existing pads on the top of the differential. Mark and drill the rear hole to 7/16" and open up the front factory holes to 7/16". Using the 7/16" bolts, washers and C-lock nuts and FT44045 ((nut tab) driver side only), secure the mount to the factory bumpstop pad. Torque to 70 ft lbs. **SEE FIGURES 59-61** Repeat on passenger side.

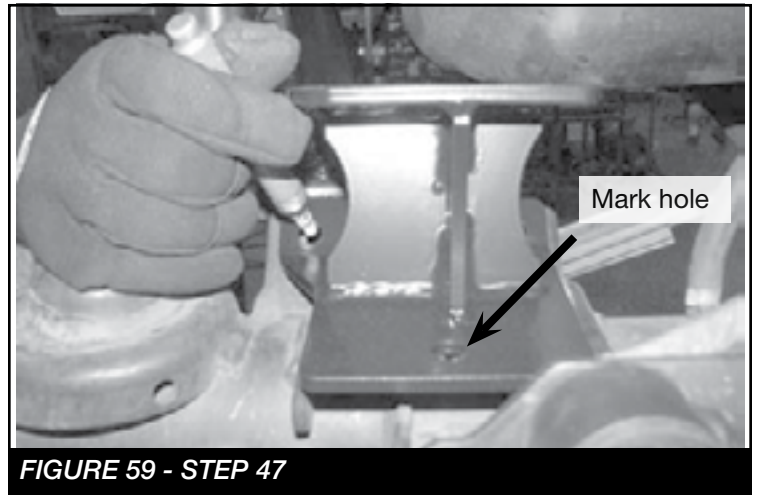

**FIGURE 59 - STEP 47**



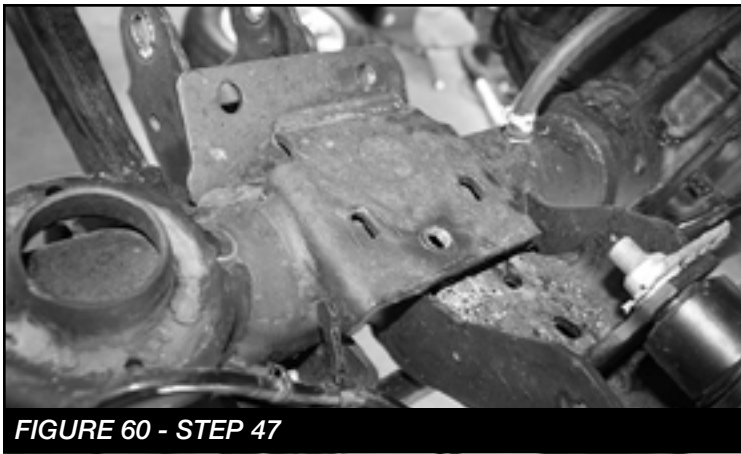

FIGURE 60 - STEP 47



FIGURE 61 - STEP 47

48. Install FT44474 & FT44475 (Driver & Pass Rear coil spacers) into the existing holes using the supplied 3/8" nuts and washers. Torque to 49 ft-lbs. **SEE FIGURES 62-63**



FIGURE 62 - STEP 48



FIGURE 63 - STEP 48

49. Locate FT44163BK (Rear Upper Link), FT44164BK (Rear Lower Links), Press the FT1038 Bushings and FT77 Sleeves from FT90111 (Bushing kit) into each end. Then install the supplied zerks fittings.
50. Install the new FT44163BK (Upper Link Arms) into the factory rear axle mounts with the factory hardware. Then attach the arm to the frame mounts also with the factory hardware. Torque to 160 ft.-lbs. **SEE FIGURE 64**

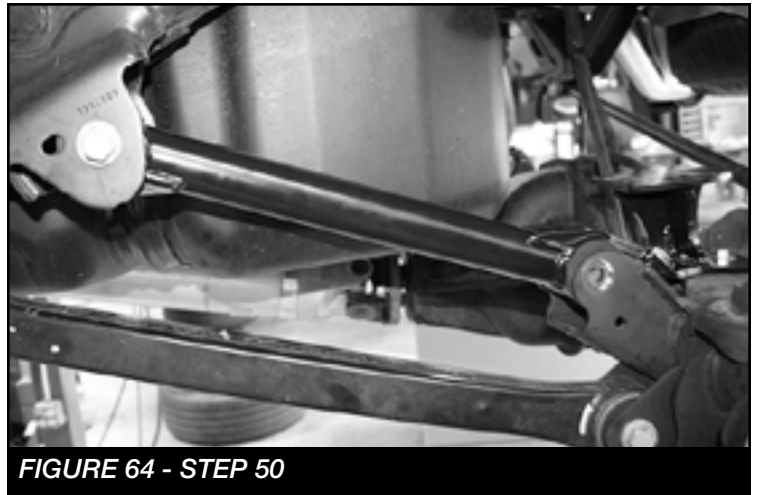

FIGURE 64 - STEP 50

51. Remove the factory lower links and save hardware. Install the new FT44464BK (Lower link arms) using the factory hardware. Torque to 160 ft-lbs. **SEE FIGURE 65**

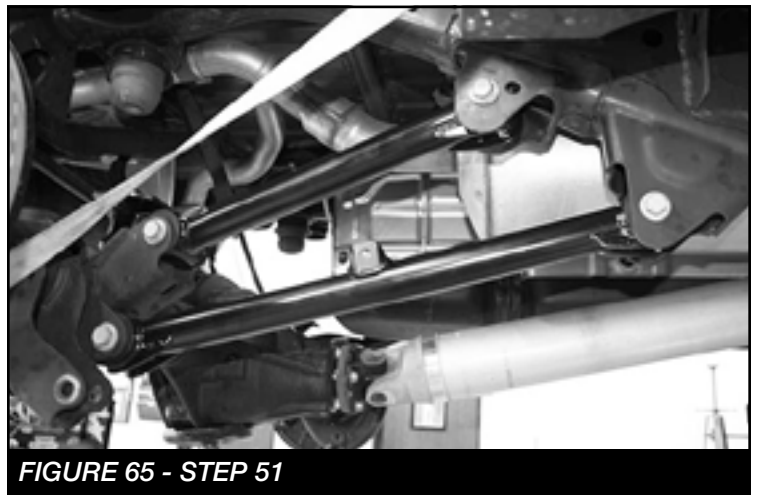
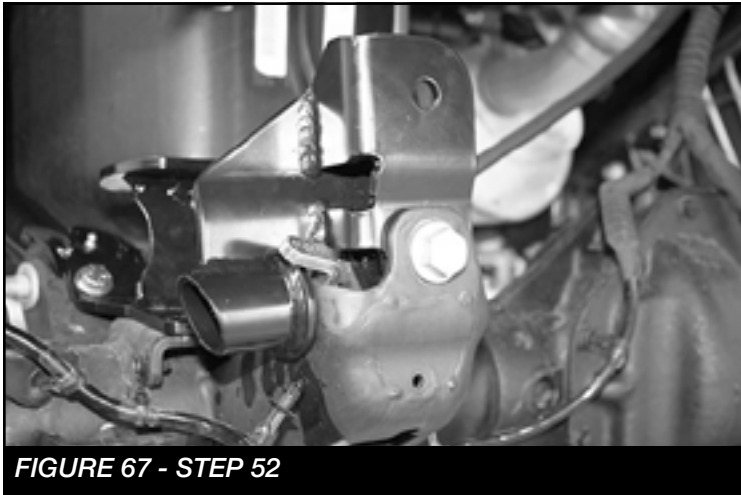

FIGURE 65 - STEP 51

52. Install FT44474 (Track bar bracket) into the factory track bar axle bracket using the factory bolt. Mark and drill the side hole to 7/16". Reinstall the bracket using factory bolt, supplied 7/16 x 1-1/4" hardware and FT44045 (Nut tab). Torque 7/16" hardware to 70 ft-lbs and the factory bolt to 160 ft-lbs. **SEE FIGURES 66-67**

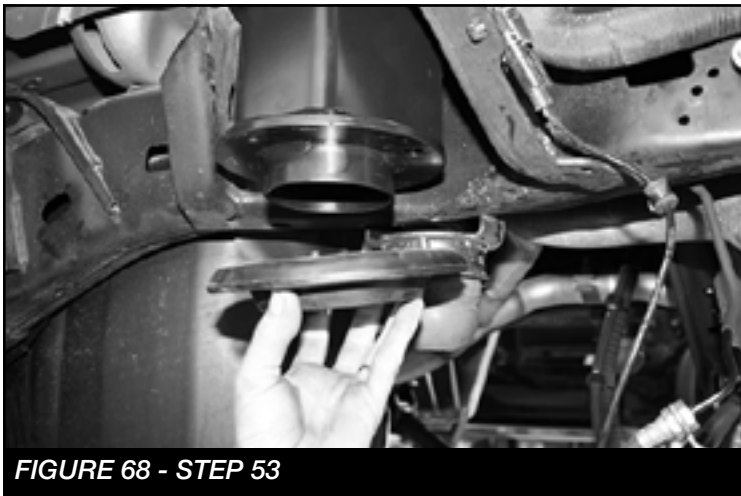

**FIGURE 66 - STEP 52**

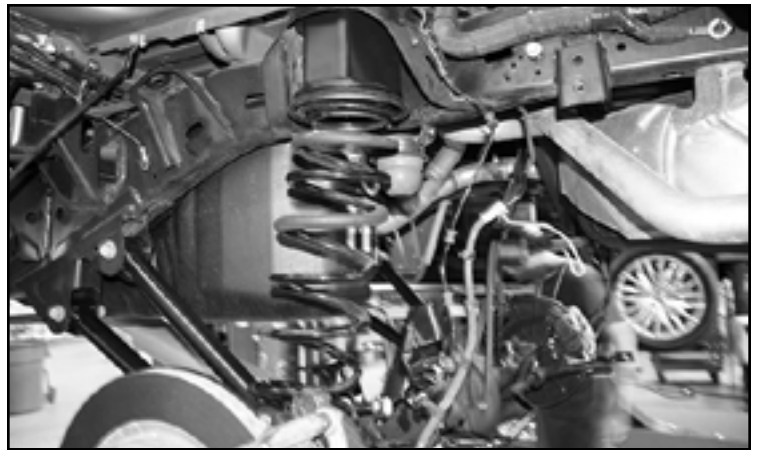

**FIGURE 67 - STEP 52**

53. Install the factory coils using the factory coil isolator. **SEE FIGURE 68-69**

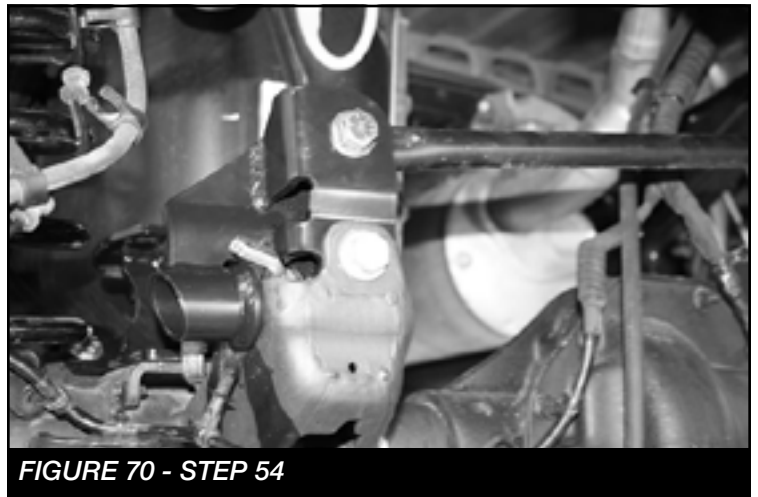

**FIGURE 68 - STEP 53**



**FIGURE 69 - STEP 53**

54. Install the factory track bar to the new bracket using the supplied 9/16 X 3" hardware. Torque to 153 ft-lbs **SEE FIGURE 70**



**FIGURE 70 - STEP 54**

55. Using a 31/64" drill bit, drill out the factory sway bar mount hole on the frame. **SEE FIGURES 71-72**

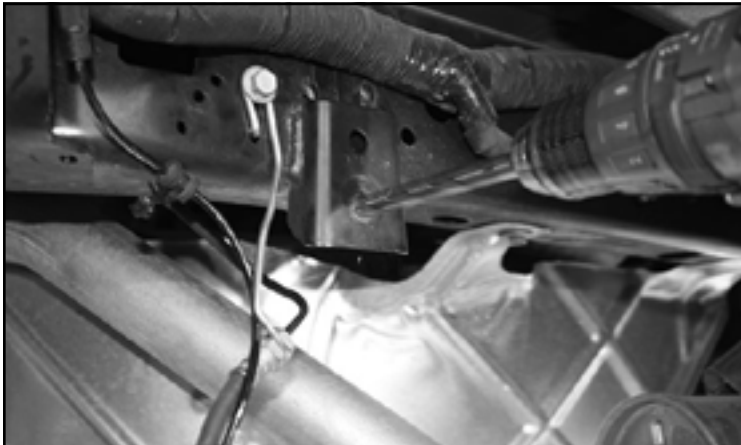

FIGURE 71 - STEP 55

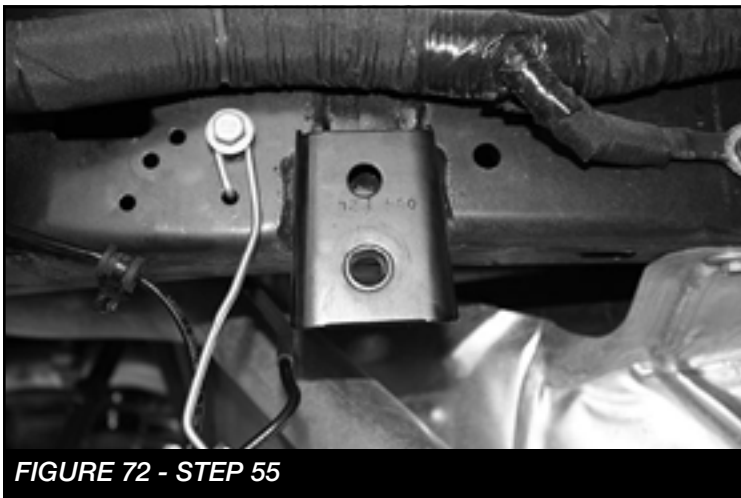

FIGURE 72 - STEP 55

56. Install the FT1004 (Bushings) & FT404739 (sleeves) in the FT1599-2-4 (sway bar endlinks). Then install the endlinks to the frame and sway bar using the supplied M12 X 70mm hardware. Torque to 93 ft-lbs **SEE FIGURE 73**



FIGURE 73 - STEP 56

57. **2020 MODELS ONLY:** Disconnect the factory brake line from the frame. Install FT44543 (Brake line bracket) to the frame using the factory hardware. Then, install the factory brake line rod bracket to the FT44543 (Bracket) using the supplied 1/4" x 3/4" hardware. Torque hardware to 8 ft-lbs. **SEE FIGURE 74**

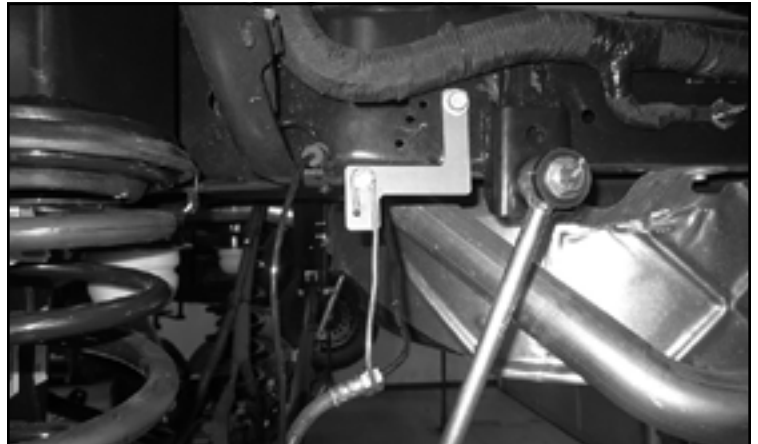

FIGURE 74 - STEP 57

58. Install the rear shocks FTS7348 (Performance), FTS6353 (Stealth) using the factory hardware at the lower mount and the supplied stem pack for the upper mount. If installing FTS811442 (Dirt Logic Shocks refer to the instructions in the shock box. **SEE FIGURES 75-76**

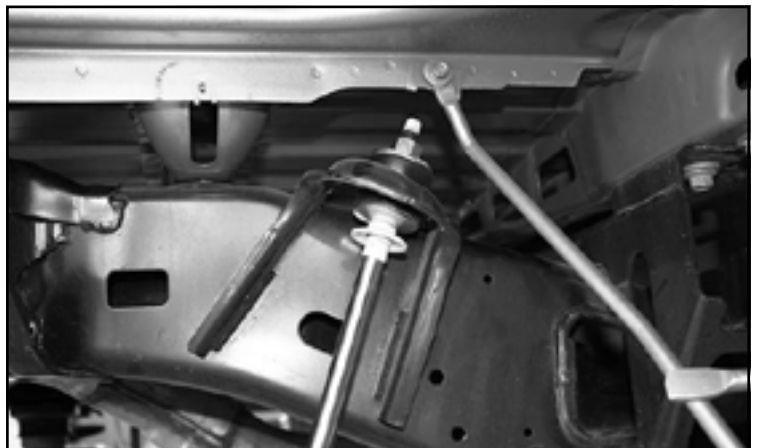

FIGURE 75 - STEP 58



FIGURE 76 - STEP 58

59. Re-install the rear fender wells.
60. Install tires and wheels and torque lug nuts to wheel manufacturer's specifications. Turn front tires left to right and check for appropriate tire clearance. **Note - Some oversized tires may require trimming of the front bumper & valance.**
61. Check front end alignment and set to factory specifications. Readjust headlights.
62. Recheck all bolts for proper torque.
63. Recheck brake hoses, ABS wires and suspension parts for proper tire clearance while turning tires fully left to right.
64. Check the fluid in the front and rear differential and fill if needed with factory specification differential oil. **Note - some differentials may expel fluid after filling and driving. This can be normal in resetting the fluid level with the new position of the differential/s.**
65. Install Driver Warning Decal. Complete product registration card and mail to Fabtech in order to receive future safety and technical bulletins on this suspension.

**Vehicles that will receive oversized tires should check ball joints, uniballs and all steering components every 2500-5000 miles for wear and replace as required.**

**RE-TORQUE ALL NUTS, BOLTS AND LUGS  
AFTER 50 MILES AND PERIODICALLY  
THEREAFTER.**

For technical assistance call: **909-597-7800**

## - Product Warranty and Warnings -

Fabtech provides a Limited Lifetime Warranty to the original retail purchaser who owns the vehicle, on which the product was originally installed, for defects in workmanship and materials.

The Limited Lifetime Warranty excludes the following Fabtech items; bushings, bump stops, ball joints, tie rod ends, limiting straps, cross shafts, heim joints and driveshafts. These parts are subject to wear and are not considered defective when worn. They are warranted for 60 days from the date of purchase for defects in workmanship.

Dirt Logic and Performance Coilover take apart shocks are considered a serviceable shock with a one year warranty on leakage only. Service seal kits are available separately for future maintenance. All other shocks are covered under our Limited Lifetime Warranty.

Fabtech does not warrant any product for finish, alterations, modifications and/or installation contrary to Fabtech's instructions. Alterations to the finish of the parts including but not limited to painting, powder coating, plating and/or welding will void all warranties. Some finish damage may occur to parts during shipping, which is considered normal and is not covered under warranty.

Fabtech products are not designed nor intended to be installed on vehicles used in race applications or for racing purposes or for similar activities. (A "RACE" is defined as any contest between two or more vehicles, or any contest of one or more vehicle against the clock, whether or not such contest is for a prize). This warranty does not include coverage for police or taxi vehicles, race vehicles, or vehicles used for government or commercial purposes. Also excluded from this warranty are sales outside of the United States of America.

Installation of most suspension products will raise the center of gravity of the vehicle and will cause the vehicle to handle differently than stock. It may increase the vehicle's susceptibility to a rollover, on road and off road, at all speeds. Extreme care should be taken to operate the vehicle safely at all times to prevent rollover or loss of control resulting in serious injury or death. Fabtech front end Desert Guards may impair the deployment or operation of vehicles equipped with supplemental restraining systems/air bag systems and should not be installed if the vehicle is equipped as so.

Fabtech makes every effort to ensure suspension product compatibility with all vehicles listed on the website, but due to unknown auto manufacturer's production changes and/or inconsistencies by the auto manufacturer, Fabtech cannot be responsible for 100% compatibility, including the fitment of tire and wheel sizes listed. The Tire and Wheel sizes listed in Fabtech's website are only a guideline for street driving with noted fender trimming. Fabtech is not responsible for damages to the vehicle's body or tires. Fabtech is not responsible for premature wear of factory components due to the installation of oversized tires and wheels.

Fabtech's obligation under this warranty is limited to the repair or replacement, at Fabtech option, of the defective product only. All costs of removal, installation or re-installation, freight charges, incidental or consequential damages are expressly excluded from this warranty. Fabtech is not responsible for damages and/or warranty of other vehicle parts related or non related to the installed Fabtech product. This warranty is expressly in lieu of all other warranties expressed or implied. This warranty shall not apply to any product that has been subject to accident, negligence, alteration, abuse or misuse as determined by Fabtech.

Fabtech suspension components must be installed as a complete system including shocks as shown on our website. All warranties will become void if Fabtech parts are combined and/or substituted with other aftermarket suspension products. Combination and/or substitution of other aftermarket suspension parts may cause premature wear and/or product failure resulting in an accident causing injury or death. Fabtech does not warrant products not manufactured by Fabtech.

Depending on the condition of the factory suspension components retained after the installation of a Fabtech suspension not all vehicles may have the same ride stance front to rear as described in the website. The blue color of suspension components shown in all Fabtech photographs are for display purposes only. Majority of all Fabtech components will be black specifically where noted with part numbers ending in BK.

Installation of Fabtech product may void the vehicles factory warranty; it is the consumer's responsibility to check with their local vehicle's dealer for warranty disposition before the installation of the product. Some state laws may prohibit modification of suspension to a vehicle in whole or in part. It is the responsibility of the installer and consumer to consult local laws prior to the installation of any Fabtech suspension product to comply with such written laws.

It is the responsibility of the distributor and/or the retailer to review all warranties and warnings of Fabtech products with the consumer prior to purchase.

Fabtech reserves the right to super cede, discontinue, change the design, finish, part number and/or application of parts when deemed necessary without written notice. Fabtech is not responsible for misprints or typographical errors within the website or price sheet. For the most recent Product Warranty and Warnings visit our website [www.fabtechmotorsports.com](http://www.fabtechmotorsports.com)