



INSTALLATION INSTRUCTIONS



2013-2016 DODGE 3500 4WD 5" RADIUS ARM KIT W/ 4.0 COILOVERS

FT23185i

Fabtech Motorsports | 4331 Eucalyptus Ave. Chino, CA 91710

Tech Line: 909-597-7800 | **Fax:** 909-597-7185 | **Web:** www.fabtechmotorsports.com

- PARTS LIST -

K3077DL		
1	FTS23114	COMPONENT BOX 1
1	FTS23185	COMPONENT BOX 2
2	FTS835102	4.0 DLSS COILOVER W/ RESI

FTS23114 COMPONENT BOX 1		
1	FT44172	DODGE PITMAN ARM
1	FT44236BK	TRACK BAR BRACKET
1	FT44243BK	BUMP STOP MOUNT DRIVER
1	FT44244BK	BUMP STOP MOUNT PASSENGER
2	FT44279BK	REAR COIL SPRING
1	FT44311BK	UPPER COIL OVER MOUNT (DRIVER)
1	FT44312BK	UPPER COIL OVER MOUNT (PASS)
1	FT44314	ABS RELOCATION BRACKET
1	FT44390BK	RESI MOUNT (DRIVER)
1	FT44391BK	RESI MOUNT (PASS)
1	FT44394BK	UPPER BACKING PLATE (DRIVER)
1	FT44395BK	UPPER BACKING PLATE (PASS)
1	FT44424	HARDWARE SUBASSEMBLY
2	FT811042	2.25" DLSS NON RESI SHOCKS

FTS23185 COMPONENT BOX 2		
2	FTBK21	BLOCK 2.0"
4	FT738U	UBOLT ROUND 9/16-18 X 12.50 X 4.00
1	FT44449	RADIUS ARM (DRIVER)
1	FT444450	RADIUS ARM (PASS)
1	FT44432	HARDWARE SUBASSEMBLY
1	FT44433	HARDWARE KIT

FT44432 HARDWARE SUBASSEMBLY		
4	FT1006	BUSHING LOWER
2	FT102	SLEEVE 1.000 X .732 X 3.280
1	FT23185i	INSTRUCTIONS
2	FT44045	TRACK BAR NUT TAB
2	FT44135	BUMP STOP MOUNT TAB
2	FT44245	BRAKE LINE EXT
1	FT44246	TRACK BAR SUPPORT SPACER
2	FT44258	1/4 NUT TAB
1	FT44388	NUT TAB UPPER
2	FT44389	NUT TAB
1	FT44408	NUT TAB
2	FT86021	HARDWARE & BUSHING KIT 21
4	FT89016	#64 HOSE CLAMP
1	FTAS16	DRIVER WARNING DECAL
1	FTAS12	STICKER FT BLUE 10X4
1	FTREGCARD	REGISTRATION CARD
2	FTS88	BUMPSTOP 1 IN TALL LOW RND

FT44424 HARDWARE SUBASSEMBLY		
1	FT44381	LOWER SHOCK MOUNT TAB DRIVER OUTER
1	FT44382	LOWER SHOCK MOUNT TAB DRIVER INNER
1	FT44383	LOWER SHOCK MOUNT TAB PASS OUTER
1	FT44384	LOWER SHOCK MOUNT TAB PASS INNER
1	FT44385	LOWER SHOCK MOUNT SPACER TOOL
1	FT44386	LOWER SHOCK GUSSET TOP DRIVER
1	FT44387	LOWER SHOCK GUSSET TOP PASS

FT44419 - HARDWARE KIT		LOCATION
BAG 1		
1	M18-2.5 X 90MM HEX BOLT	TRACK BAR DROP BRACKET
2	M18 WASHERS	
1	NUT C-LOCK 18MM G10.9 ZINC	
2	1/2-13 C-LOCK NUT ZINC	
2	1/2-13 X 1-1/2 HEX BOLT G8 ZNC	TRACK BAR DROP BRACKET
6	1/2 SAE WASHER G8 ZINC	
4	1/4 SAE WASHER G5 ZINC	
2	1/4-20 NYLOCK NUT	
2	1/4-20 X 1" HEX BOLT	
2	5/16-18 X 2-1/2 HEX BOLT G8 ZINC	BUMP STOP
4	5/16 SAE WASHER G8 ZINC	
2	5/16-18 C-LOCK NUT ZINC	
2	1/2-13 X 1-1/4 HEX BOLT G8 ZNC	BUMP STOP
2	1/4-28 GREASE FITTING	
BAG 2		
10	7/16-14 X 1-1/2 HEX BOLT G8	
2	7/16 SPLIT LOCK WASHER	
1	7/16-14 X 1-1/4 HEX BOLT G8	
2	7/16 USS WASHER G8	
20	7/16 SAE WASHER G8 ZINC	
9	7/16-14 C-LOCK NUT	
6	5/8 SAE WASHER	
2	5/8-11 C-LOCK NUT	
2	5/8-11 X 3-1/4 HEX BOLT G8	
2	5/8-11 X 4 SOCKET HD BOLT	
4	3/8" SAE WASHER	
2	3/8-16 X 1-1/4" HEX BOLT	
2	3/8-16 C-LOCK NUT	
4	1/4-20 X 1 HEX BOLT G5 ZINC	BRAKE LINE EXTENSION
2	1/4 SAE WASHER G5 ZINC	
2	1/4-20 C-LOCK NUT ZINC	
BAG 3		
4	7/16-14 X 1-1/4 HEX BOLT G8 ZC	REAR BUMP STOP
4	7/16-14 C-LOCK NUT ZINC	
8	9/16 SAE WASHER	UBOLTS
8	9/16-18 NYLOCK NUT	



- TOOL LIST -

Required Tools (Not Included)

Basic Hand Tools
Floor Jack
Jack Stands
Assorted Metric and S.A.E sockets, and Allen wrenches
Torque Wrench
Die Grinder w/ Cutoff Wheel or Sawzall

- PRE-INSTALLATION NOTES -

For technical assistance call: **909-597-7800** or e-mail: **info@fabtechmotorsports.com**

Read this before you begin installation-

Check all parts to the parts list above before beginning installation. If any parts are missing contact Fabtech at 909-597-7800 and a replacement part will be sent to you immediately.

Read all instructions thoroughly from start to finish before beginning the installation. If these instructions are not properly followed severe frame, driveline and / or suspension damage may occur.

Check your local city and state laws prior to the installation of this system for legality. Do not install if not legal in your area.

Prior to the installation of this suspension system perform a front end alignment and record. Do not install this system if the vehicle alignment is not within factory specifications. Check for frame and suspension damage prior to installation.

The installation of this suspension system should be performed by two professional mechanics.

This suspension must be installed with Fabtech shock absorbers.

Use the provided thread locking compound on all hardware.

WARNING- Installation of this system will alter the center of gravity of the vehicle and may increase roll over as compared to stock.

Vehicles that receive oversized tires should check ball joints, uniballs, tie rods ends, pitman arm and idler arm every 2500-5000 miles for wear and replace as needed.

Verify differential fluid is at manufactures recommended level prior to kit installation. Installation of the kit will reposition the differential and the fill plug hole may be in a different position. (For example, if the manufacture recommends 3 quarts of fluid, make sure the diff has 3 quarts of fluid). Check your specific manual for correct amount of fluid.

RECOMMENDED TIRE/WHEEL SIZES -

Use 37x12.50/R17 tire w/ 17x9 wheels w/ 5" BS w/ minor trimming

Use 37x12.50/R18 tire w/ 18x9 wheels w/ 5" BS w/ minor trimming

Use 37x13.50/R20 tire w/ 20x9.5 wheels w/ 5" BS w/ minor trimming

Use 37x13.50/R22 tire w/ 22x11 wheels w/ 5" BS w/ minor trimming

- INSTRUCTIONS -

FRONT SUSPENSION

1. Disconnect the negative terminal on the battery. Jack up the front end of the truck and support the frame rails with jack stands. **NEVER WORK UNDER AN UNSUPPORTED VEHICLE!** Remove the front tires.
2. **DRIVER SIDE ONLY** - Starting on the driver side, remove the driver side fender liner.
3. Remove the factory shock and discard. Retain factory lower hardware.
4. Disconnect factory sway bar links.
5. Remove factory coil spring and rubber isolator. Retain these parts for later use.
6. Remove the factory pitman arm and discard. Keep hardware.
7. Locate the new FT44172 Fabtech pitman arm and install. Do not reconnect the factory drag link at this time. Reinstall the factory lock washer plus thread locker. Torque to 220ft-lbs.
8. Unthread the factory drag link at the adjuster sleeve and remove adjuster sleeve. **SEE FIGURE 1**

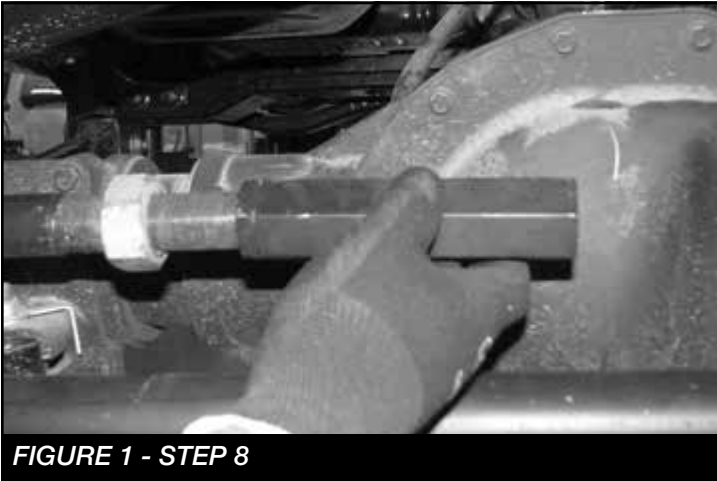

FIGURE 1 - STEP 8

9. Using a die grinder remove the flat nonthreaded section from both ends of the drag link. This will allow you to rotate the drag link and line it up with the pitman arm. **SEE FIGURES 2-4**



FIGURE 2 - STEP 9



FIGURE 3 - STEP 9

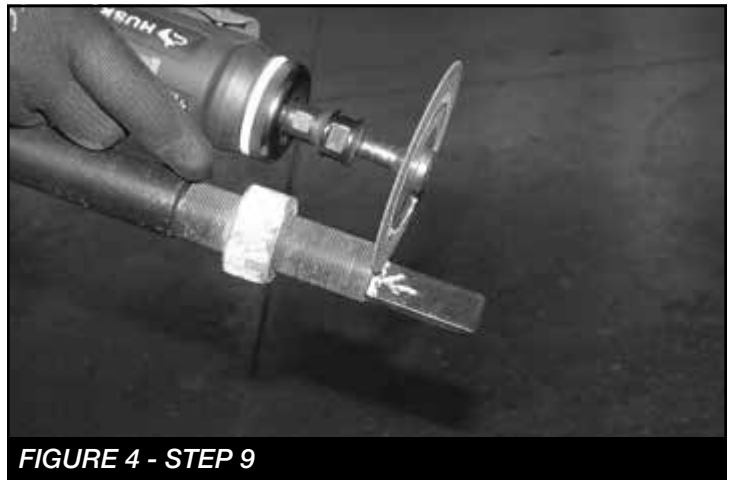
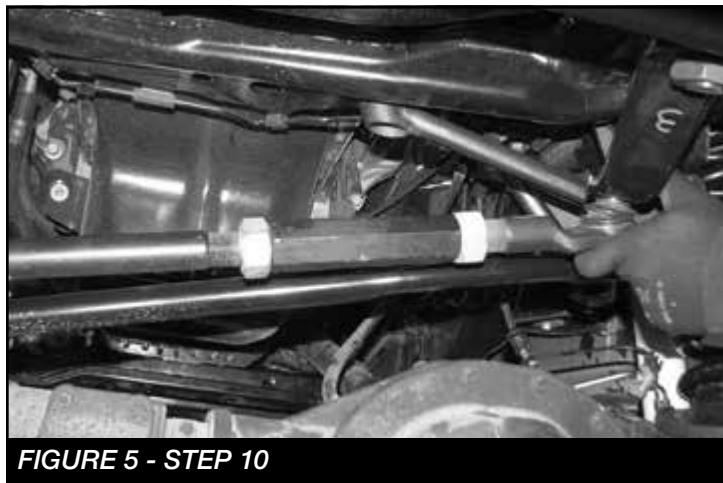

FIGURE 4 - STEP 9

10. Reassemble the drag link and connect it to the new pitman arm. **SEE FIGURE 5**



11. Torque the drag link to 83 ft-lbs.
12. Remove the track bar from the frame side of the vehicle.
13. Locate the FT44236BK track bar bracket and M18-2.5 x 90mm bolt.
14. Slide the track bar bracket into the factory mount and insert the M18 bolt into the factory pivot hole. **SEE FIGURE 6**



15. Rotate the bracket up until the end of the bracket is flush with the crossmember under the motor.
16. Using the Fabtech bracket as a guide, mark the factory mount for the upper driver side mounting hole.

17. Swing the bracket back out of the way. Using a 1/2" drill bit, drill out the marked hole. **SEE FIGURE 7**



18. Locate one FT44246 sleeve and two 1/2"-13 x 1-1/2" bolts, nuts and washers.
19. Rotate the track bar bracket back into place and bolt together using 1/2"-13 x 1-1/2" bolt and the sleeve. **SEE FIGURES 8-9**

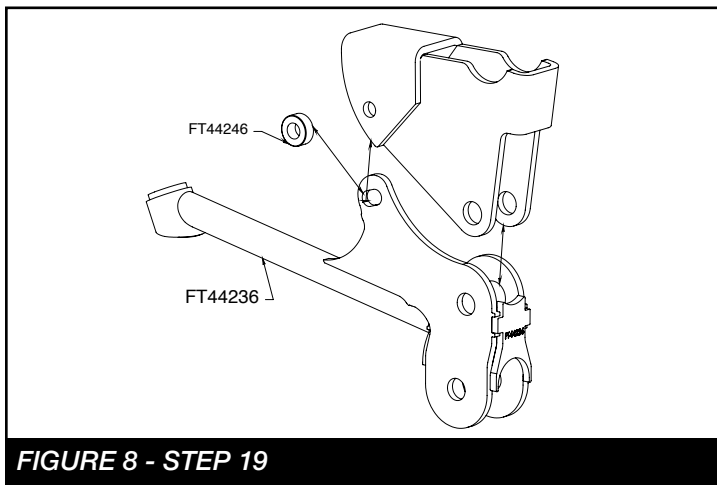

20. Using the Fabtech bracket as a guide, drill a 1/2" hole in the cross member under the motor. Next, mount using 1/2"-13x1.5" and washer. **SEE FIGURE 10**



FIGURE 10 - STEP 20

21. Remove the factory coil springs and lower rubber isolators. **SEE FIGURE 11**



FIGURE 11 - STEP 21

- **IF INSTALLING DIRT LOGIC 4.0 COILOVERS REFER TO THE COILOVER CONVERSION INSTRUCTIONS AT THIS TIME.**

22. Locate and remove the factory rubber bump stop. **SEE FIGURE 12**



FIGURE 12 - STEP 22

23. Using a die grinder, grind out the stamped in tabs on the inside of the bump stop housing. **SEE FIGURES 13-14**



FIGURE 13 - STEP 23



FIGURE 14 - STEP 23

24. Locate the FT44243BK driver front bump stop and the FT44135 nut tab.

25. Using a 1/2" drill bit, drill out the hole in the factory crossmember inline with the factory bump stop mount. **SEE FIGURE 15**

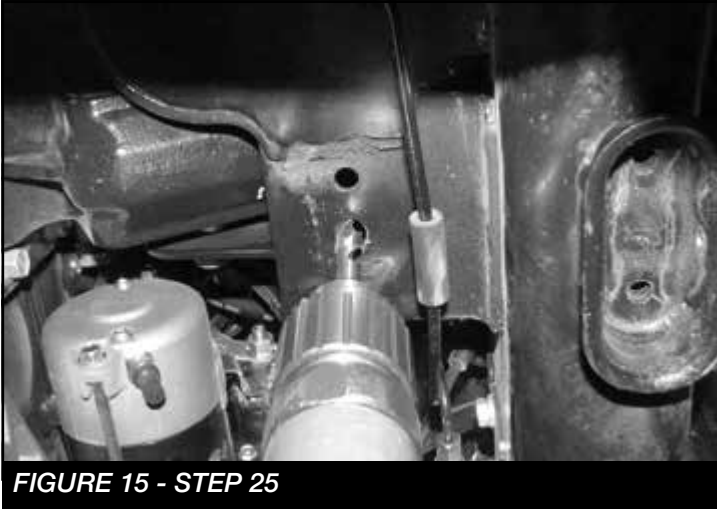

FIGURE 15 - STEP 25

26. Slide the bump stop into the factory bump stop mount. Using a 1/2"-13 x 1-1/4" bolt and the FT44135 (nut tab), bolt the bump stop to the crossmember. Torque the 1/2" bolt to 90 ft-lbs. **SEE FIGURES 16-18**



FIGURE 16 - STEP 26



FIGURE 17 - STEP 26



FIGURE 18 - STEP 26

27. Using the outer tab on the bump stop as a drill guide, drill a 5/16" hole all the way through the factory bump stop mount. **SEE FIGURE 19**

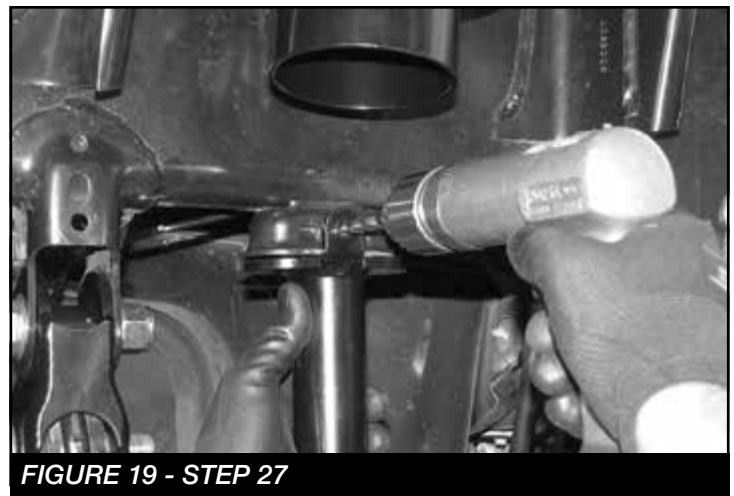

FIGURE 19 - STEP 27

28. Locate a 5/16"-18 x 2-1/2" bolt, nut and washers. Using this bolt, secure the bump stop to the factory bump stop mount and torque to 29 ft-lbs. **SEE FIGURE 20**



FIGURE 20 - STEP 28

29. Locate the FTS88 bump stop pad and thread it into the bottom of the Fabtech bump stop. **SEE FIGURE 21**

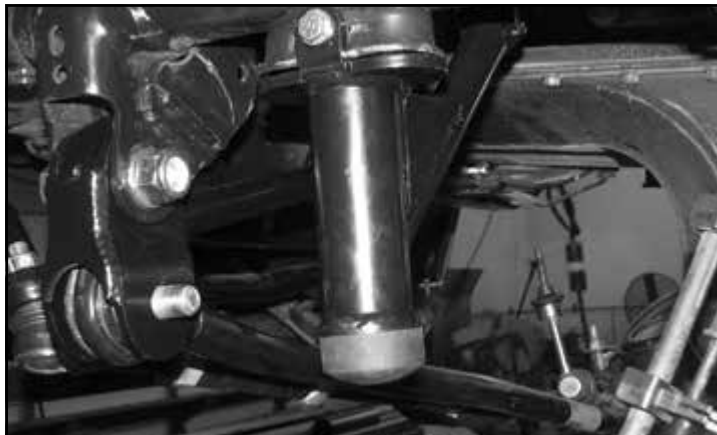

FIGURE 21 - STEP 29

30. Repeat steps 2-29 on the passenger side.
31. Secure the front diff. Remove the factory driver and passenger side Radius arm. Retain Hardware. **SEE FIGURES 22-23**



FIGURE 22 - STEP 31

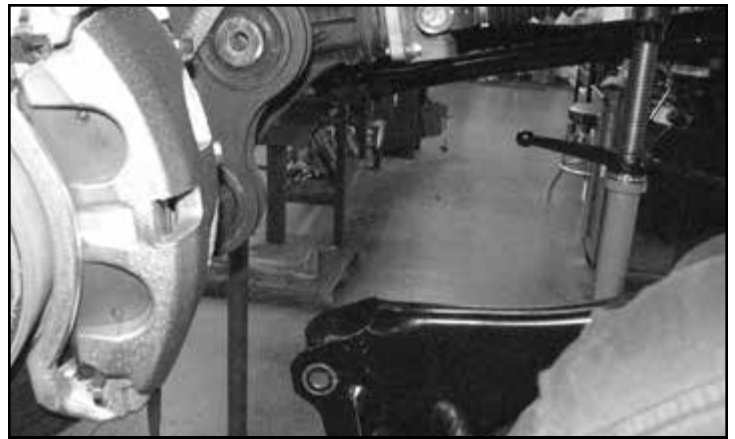

FIGURE 23 - STEP 31

32. Locate the FT44449 Driver side radius arm, FT1006 bushing, FT102 sleeve, and zerk fitting.
33. Install two bushings, one sleeve, and the zerk fitting into the barrel of the radius arm. **SEE FIGURES 24-26**



FIGURE 24 - STEP 33



FIGURE 25 - STEP 33



FIGURE 26 - STEP 33

34. Install the new Fabtech radius arms into the factory frame pocket and onto the axle bushings using the factory hardware. Torque the factory bolts to 200 ft-lbs. **SEE FIGURES 27-29**



FIGURE 27 - STEP 34



FIGURE 28 - STEP 34



FIGURE 29 - STEP 34

- 35. REPEAT STEPS 31-34 ON THE PASSENGER SIDE.**

36. Locate the FT44245 Brake line extension, FT44258 nut tab and two 1/4"-20 x 1" bolts. Attach the brake line extension to the axle using one bolt and the nut tab. Attach the factory brake line bracket to the Fabtech extension. Torque to 10 ft-lbs. Repeat this step on the passenger side. **SEE FIGURES 30-31**

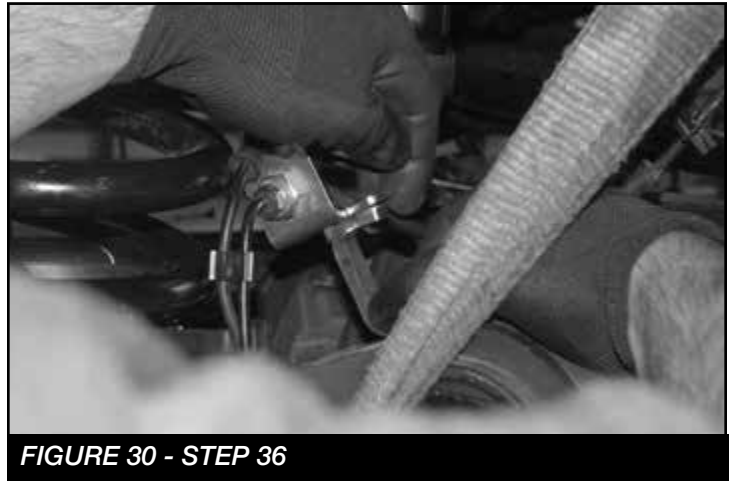

FIGURE 30 - STEP 36

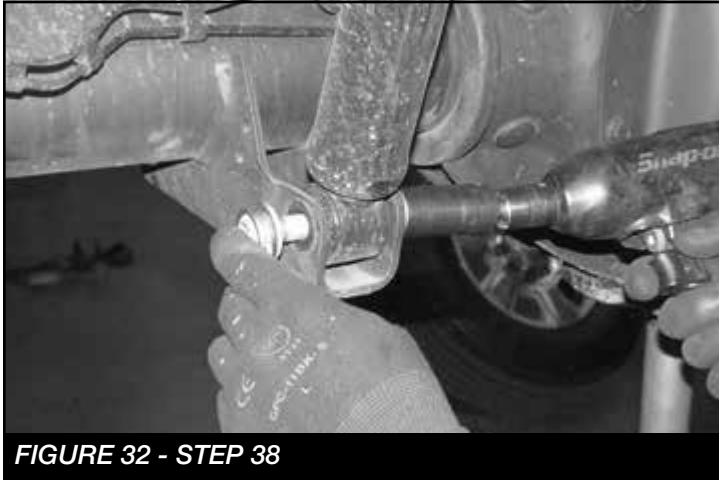

FIGURE 31 - STEP 36

37. Reconnect the factory sway bar. Torque to 29 ft-lbs.

REAR SUSPENSION

38. Jack up the rear end of the vehicle and support the frame rails with jack stands. Supporting the rear differential, remove and discard the rear shocks and u-bolts. Lower the axle down slowly. Use care not to over extend the brake hoses. **SEE FIGURES 32-33**



39. Locate the supplied 2" blocks FTBK21, FT738U u-bolts and 9/16" hardware. Install the block onto the axle with the small end of the taper to front of the truck. Using the supplied u-bolts, nuts and washers, align axle, lift block and springs and torque to u-bolts to 129 ft-lbs. **SEE FIGURES 34-37**



40. Install new Dirt Logic 2.25" (FTS835102) with the factory hardware and torque upper and lower bolts to 29 ft-lbs.
41. Remove driver and passenger factory bump stop. Retain Hardware.

42. Install the new FT44242BK bump stop extension to the factory mount using the factory hardware and torque to 65 ft-lbs.

SEE FIGURE 38

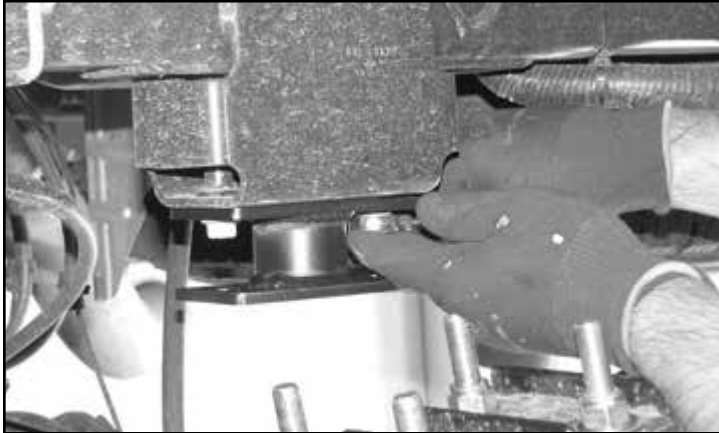

FIGURE 38 - STEP 42

43. Using 7/16"-14 x 1-1/4" bolt, nuts and washers, mount the factory bump stop to the extension. Torque to 59 ft-lbs. **SEE FIGURES 39-40**

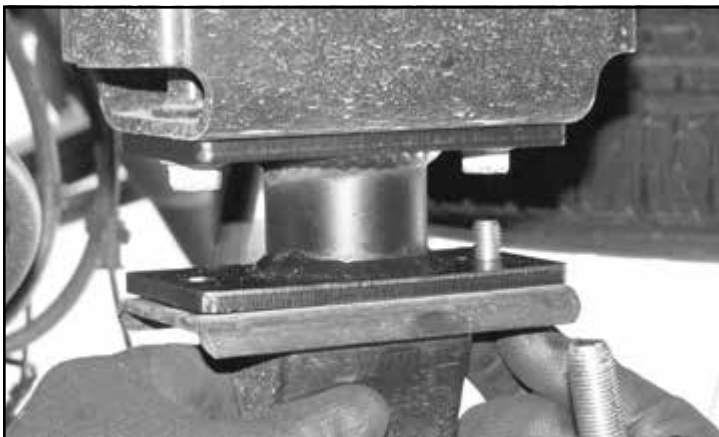

FIGURE 39 - STEP 43

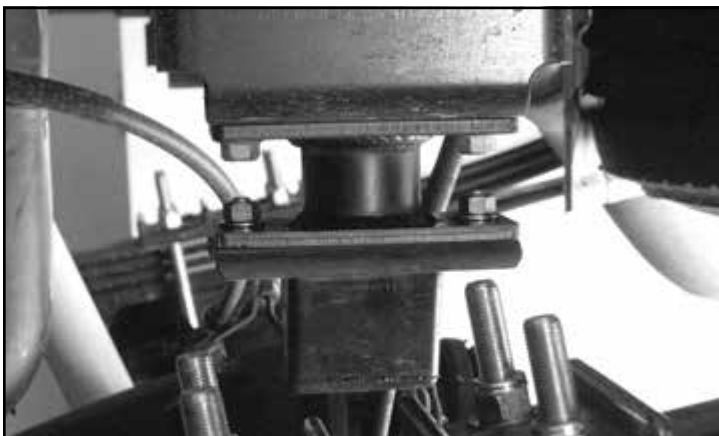

FIGURE 40 - STEP 43

44. Install tires and wheels and torque lug nuts to wheel manufacturer's specifications. Turn front tires left to right and check for appropriate tire clearance. **Note - Some oversized tires may require trimming of the front bumper & valance.**
45. Check front end alignment and set to factory specifications. Readjust headlights.
46. Recheck all bolts for proper torque.
47. Recheck brake hoses, ABS wires and suspension parts for proper tire clearance while turning tires fully left to right.
48. Check the fluid in the front and rear differential and fill if needed with factory specification differential oil. **Note - some differentials may expel fluid after filling and driving. This can be normal in resetting the fluid level with the new position of the differential/s.**
49. Install Driver Warning Decal. Complete product registration card and mail to Fabtech in order to receive future safety and technical bulletins on this suspension.

Vehicles that will receive oversized tires should check ball joints, uniballs and all steering components every 2500-5000 miles for wear and replace as required.

RETORQUE ALL NUTS, BOLTS AND LUGS AFTER 50 MILES AND PERIODICALLY THEREAFTER.

For technical assistance call: **909-597-7800**

- Product Warranty and Warnings -

Fabtech provides a Limited Lifetime Warranty to the original retail purchaser who owns the vehicle, on which the product was originally installed, for defects in workmanship and materials.

The Limited Lifetime Warranty excludes the following Fabtech items; bushings, bump stops, ball joints, tie rod ends, limiting straps, cross shafts, heim joints and driveshafts. These parts are subject to wear and are not considered defective when worn. They are warranted for 60 days from the date of purchase for defects in workmanship.

Dirt Logic and Performance Coilover take apart shocks are considered a serviceable shock with a one year warranty on leakage only. Service seal kits are available separately for future maintenance. All other shocks are covered under our Limited Lifetime Warranty.

Fabtech does not warrant any product for finish, alterations, modifications and/or installation contrary to Fabtech's instructions. Alterations to the finish of the parts including but not limited to painting, powder coating, plating and/or welding will void all warranties. Some finish damage may occur to parts during shipping, which is considered normal and is not covered under warranty.

Fabtech products are not designed nor intended to be installed on vehicles used in race applications or for racing purposes or for similar activities. (A "RACE" is defined as any contest between two or more vehicles, or any contest of one or more vehicle against the clock, whether or not such contest is for a prize). This warranty does not include coverage for police or taxi vehicles, race vehicles, or vehicles used for government or commercial purposes. Also excluded from this warranty are sales outside of the United States of America.

Installation of most suspension products will raise the center of gravity of the vehicle and will cause the vehicle to handle differently than stock. It may increase the vehicle's susceptibility to a rollover, on road and off road, at all speeds. Extreme care should be taken to operate the vehicle safely at all times to prevent rollover or loss of control resulting in serious injury or death. Fabtech front end Desert Guards may impair the deployment or operation of vehicles equipped with supplemental restraining systems/air bag systems and should not be installed if the vehicle is equipped as so.

Fabtech makes every effort to ensure suspension product compatibility with all vehicles listed on the website, but due to unknown auto manufacturer's production changes and/or inconsistencies by the auto manufacturer, Fabtech cannot be responsible for 100% compatibility, including the fitment of tire and wheel sizes listed. The Tire and Wheel sizes listed in Fabtech's website are only a guideline for street driving with noted fender trimming. Fabtech is not responsible for damages to the vehicle's body or tires. Fabtech is not responsible for premature wear of factory components due to the installation of oversized tires and wheels.

Fabtech's obligation under this warranty is limited to the repair or replacement, at Fabtech option, of the defective product only. All costs of removal, installation or re-installation, freight charges, incidental or consequential damages are expressly excluded from this warranty. Fabtech is not responsible for damages and/or warranty of other vehicle parts related or non related to the installed Fabtech product. This warranty is expressly in lieu of all other warranties expressed or implied. This warranty shall not apply to any product that has been subject to accident, negligence, alteration, abuse or misuse as determined by Fabtech.

Fabtech suspension components must be installed as a complete system including shocks as shown on our website. All warranties will become void if Fabtech parts are combined and/or substituted with other aftermarket suspension products. Combination and/or substitution of other aftermarket suspension parts may cause premature wear and/or product failure resulting in an accident causing injury or death. Fabtech does not warrant products not manufactured by Fabtech.

Depending on the condition of the factory suspension components retained after the installation of a Fabtech suspension not all vehicles may have the same ride stance front to rear as described in the website. The blue color of suspension components shown in all Fabtech photographs are for display purposes only. Majority of all Fabtech components will be black specifically where noted with part numbers ending in BK.

Installation of Fabtech product may void the vehicles factory warranty; it is the consumer's responsibility to check with their local vehicle's dealer for warranty disposition before the installation of the product. Some state laws may prohibit modification of suspension to a vehicle in whole or in part. It is the responsibility of the installer and consumer to consult local laws prior to the installation of any Fabtech suspension product to comply with such written laws.

It is the responsibility of the distributor and/or the retailer to review all warranties and warnings of Fabtech products with the consumer prior to purchase.

Fabtech reserves the right to super cede, discontinue, change the design, finish, part number and/or application of parts when deemed necessary without written notice. Fabtech is not responsible for misprints or typographical errors within the website or price sheet. For the most recent Product Warranty and Warnings visit our website www.fabtechmotorsports.com