



INSTALLATION INSTRUCTIONS



2014-2015 DODGE 2500 4WD 5" 4-LINK KIT W/ 4.0 COILOVERS

FTS23117

Fabtech Motorsports | 4331 Eucalyptus Ave. Chino, CA 91710

Tech Line: 909-597-7800 | **Fax:** 909-597-7185 | **Web:** www.fabtechmotorsports.com

K3073DL		
1	FTS23114	COMPONENT BOX 1
1	FTS23117	COMPONENT BOX 2
2	FTS835102	4.0 DLSS COILOVER W/ RESI

FTS23114 COMPONENT BOX 1		
1	FT44172	DODGE PITMAN ARM
1	FT44236BK	TRACK BAR BRACKET
1	FT44243BK	BUMP STOP MOUNT DRIVER
1	FT44244BK	BUMP STOP MOUNT PASSENGER
2	FT44279BK	REAR COIL SPRING
1	FT44311BK	UPPER COIL OVER MOUNT (DRIVER)
1	FT44312BK	UPPER COIL OVER MOUNT (PASS)
1	FT44314	ABS RELOCATION BRACKET
1	FT44390BK	RESI MOUNT (DRIVER)
1	FT44391BK	RESI MOUNT (PASS)
1	FT44394BK	UPPER BACKING PLATE (DRIVER)
1	FT44395BK	UPPER BACKING PLATE (PASS)
1	FT44424	HARDWARE SUBASSEMBLY

FTS23117 COMPONENT BOX 2		
2	FT1599-2-4	5" SWAY BAR LINK CLEAR ZINC
1	FT44269BK	REAR TRACK BAR SUPPORT
1	FT44300BK	4-LINK BRACKET (DRIVER)
1	FT44301BK	4-LINK BRACKET (PASSENGER)
1	FT44303BK	4-LINK UPPER (DRIVER)
1	FT44304BK	4-LINK UPPER (PASSENGER)
1	FT44305BK	4-LINK LOWER (DRIVER)
1	FT44306BK	4-LINK LOWER (PASSENGER)
2	FT44318BK	CROSSMEMBER BACK PLATE
2	FT44268BK	REAR BUMP STOP SPACER
1	FT44420	HARDWARE SUBASSEMBLY
1	FT44421	HARDWARE KIT

FT44424 HARDWARE SUBASSEMBLY		
1	FT44381	LOWER SHOCK MOUNT TAB DRIVER OUTER
1	FT44382	LOWER SHOCK MOUNT TAB DRIVER INNER
1	FT44383	LOWER SHOCK MOUNT TAB PASS OUTER
1	FT44384	LOWER SHOCK MOUNT TAB PASS INNER
1	FT44385	LOWER SHOCK MOUNT SPACER TOOL
1	FT44386	LOWER SHOCK GUSSET TOP DRIVER
1	FT44387	LOWER SHOCK GUSSET TOP PASS

FT44421 - HARDWARE KIT		LOCATION
	BAG 1	
1	M18-2.5 X 90MM HEX BOLT	TRACK BAR DROP BRACKET
2	M18 WASHERS	
1	NUT C-LOCK 18MM G10.9 ZINC	
2	1/2-13 X 1-1/2 HEX BOLT G8 ZINC	TRACK BAR BRACKET
8	1/2" WASHERS	
4	1/2 -13 C-LOCK NUT ZINC	
2	1/2-13 1-1/4 HEX BOLT ZINC	
2	5/16-18 X 2-1/2 HEX BOLT ZINC	BUMP STOP
4	5/16 SAE WASHER G8 ZINC	
2	5/16-18 C-LOCK NUT ZINC	
4	1/4-20 X 1 HEX BOLT G5 ZINC	BRAKE LINE EXTENSION
2	1/4 SAE WASHER G5 ZINC	
2	1/4-20 C-LOCK NUT ZINC	
	BAG 2	
10	7/16-14 X 1-1/2 HEX BOLT ZINC	
20	7/16 SAE WASHER G8 ZINC	
9	7/16-14 C-LOCK NUT ZINC	
1	7/16-14 X 1-1/4 HEX BOLT ZINC	
2	7/16 SPLIT LOCK WASHER	
2	7/16 USS WASHER	
2	5/8-11 X 3-1/4" BOLT	
2	5/8" SAE WASHER	
2	5/8-11 X 4" SOCKET HEAD BOLT	
2	5/8-11 C-LOCK NUT	
4	5/8 SAE WASHER	
2	3/8-16 X 1-1/4" BOLT	
4	3/8" SAE WASHER	
2	3/8-16 C-LOCK NUT	
2	1/4-20 X 1" BOLT	
4	1/4" SAE WASHER	
2	1/4-20 NYLOCK NUT	
	BAG 3	
8	1/2 USS WASHER G5 ZINC	SWAY BAR LINK
4	M12-1.75 X 70MM HEX BOLT G10.9	
4	NUT 12-1.75 NYLOK 10.9 Z1	
5	7/16-14 X 1-1/4 HEX BOLT G8 ZC	REAR TRACK BAR BRACKET
10	7/16 SAE WASHER G8 ZINC	
5	7/16-14 C-LOCK NUT ZINC	
1	1/2-13 X 1-1/4 HEX BOLT G8 ZNC	REAR TRACK BAR BRACKET
1	1/2-13 X 2-1/4 HEX BOLT G8 ZNC	
4	1/2 SAE WASHER G8 ZINC	
2	1/2-13 C-LOCK NUT ZINC	
1	9/16-18 X 4 HEX BOLT G8 ZC	
2	9/16 SAE WASHER G8 ZINC	
1	9/16" -18 C LOCK NUT	
1	1/4-20 X 1 HEX BOLT G8 ZINC	
2	1/4 SAE WASHER G5 ZINC	

1	1/4-20 NYLOCK NUT ZINC	REAR END BREATHER
1	SPN-10 CUSHIONED CLAMP	
	BAG 4	4-LINK
10	5/8"-11 X 1-3/4" HEX BOLT	
20	5/8 SAE WASHER	
2	7/16-14 X 1-1/4" HEX BOLT	
2	7/16 SAE WASHER	
2	7/16 SPLIT LOCK WASHER	
2	3/4-10 X 1-1/4" HEX BOLT	
2	3/4-10 X 2" HEX BOLT	
20	3/4" SAE WASHER	
4	3/4-10 X 5" HEX BOLT	
8	3/4-10 C-LOCK NUT	
4	1/2-13 X 1-1/2" HEX BOLT	
6	1/2" SAE WASHER	
2	1/2-13 C-LOCK NUT	

FT44420		HARDWARE SUBASSEMBLY
2	FTSP01029	HARDWARE PACK STEM BUSHING
2	FT86021	HARDWARE & BUSHING KIT 21
4	FT89016	#64 HOSE CLAMP
1	FT605	SLEEVE 1.000 X .563 X 1.855
1	FT606	SLEEVE .750 X .515 X .780
8	FT1004	SWAY BAR LINK BUSHING HALF
2	FT44135	BUMP STOP MOUNT TAB
2	FT44245	BRAKE LINE EXT
1	FT44246	TRACK BAR SUPPORT SPACER
2	FT44258	1/4 NUT TAB
1	FT44270	NUT TAB
1	FT50184	TRAC BAR SUPPORT NUT TAB
2	FTS88	BUMPSTOP 1 IN TALL LOW RND
4	FT404739	SWAY BAR SLEEVE
1	FTAS16	DRIVER WARNING DECAL
1	FTAS12	STICKER FT BLUE 10X4
1	FTREGCARD	REGISTRATION CARD
1	FT23117i	INSTRUCTIONS
4	FT103	MISALIGNMENT SPACER
2	FT44045	TRACK BAR NUT TAB
1	FT44388	NUT TAB UPPER
2	FT44389	NUT TAB
1	FT44408	SLEEVE 1.00 X .625 X 2.035
1	FT30182	NUT TAB
1	FT44223	NUT TAB
4	FT44302	MISALIGNMENT
2	FT44324	NUT TAB



- TOOL LIST -

Required Tools (Not Included)

Basic Hand Tools
Floor Jack
Jack Stands
Assorted Metric and S.A.E sockets, and Allen wrenches
Torque Wrench
Die Grinder w/ Cutoff Wheel or Sawzall

- PRE-INSTALLATION NOTES -

For technical assistance call: **909-597-7800** or e-mail: **info@fabtechmotorsports.com**

Read this before you begin installation-

Check all parts to the parts list above before beginning installation. If any parts are missing contact Fabtech at 909-597-7800 and a replacement part will be sent to you immediately.

Read all instructions thoroughly from start to finish before beginning the installation. If these instructions are not properly followed severe frame, driveline and / or suspension damage may occur.

Check your local city and state laws prior to the installation of this system for legality. Do not install if not legal in your area.

Prior to the installation of this suspension system perform a front end alignment and record. Do not install this system if the vehicle alignment is not within factory specifications. Check for frame and suspension damage prior to installation.

The installation of this suspension system should be performed by two professional mechanics.

This suspension must be installed with Fabtech shock absorbers.

Use the provided thread locking compound on all hardware.

WARNING- Installation of this system will alter the center of gravity of the vehicle and may increase roll over as compared to stock.

Vehicles that receive oversized tires should check ball joints, uniballs, tie rods ends, pitman arm and idler arm every 2500-5000 miles for wear and replace as needed.

Verify differential fluid is at manufactures recommended level prior to kit installation. Installation of the kit will reposition the differential and the fill plug hole may be in a different position. (For example, if the manufacture recommends 3 quarts of fluid, make sure the diff has 3 quarts of fluid). Check your specific manual for correct amount of fluid.

RECOMMENDED TIRE/WHEEL SIZES -

Use 37x12.50/R17 tire w/ 17x9 wheels w/ 5" BS w/ minor trimming

Use 37x12.50/R18 tire w/ 18x9 wheels w/ 5" BS w/ minor trimming

Use 37x13.50/R20 tire w/ 20x9.5 wheels w/ 5" BS w/ minor trimming

Use 37x13.50/R22 tire w/ 22x11 wheels w/ 5" BS w/ minor trimming

- INSTRUCTIONS -

FRONT SUSPENSION

1. Disconnect the negative terminal on the battery. Jack up the front end of the truck and support the frame rails with jack stands. **NEVER WORK UNDER AN UNSUPPORTED VEHICLE!** Remove the front tires.
2. **DRIVER SIDE ONLY** - Starting on the driver side, remove the driver side fender liner.
3. Remove the factory shock and discard. Retain factory lower hardware.
4. Disconnect factory sway bar links.
5. Remove factory coil spring.
6. Remove the factory pitman arm and discard. Keep hardware.
7. Locate the new FT44172 Fabtech pitman arm and install. Do not reconnect the factory drag link at this time. Reinstall the factory lock washer plus thread locker. Torque to 220ft-lbs.
8. Unthread the factory drag link at the adjuster sleeve and remove adjuster sleeve. **SEE FIGURE 1**

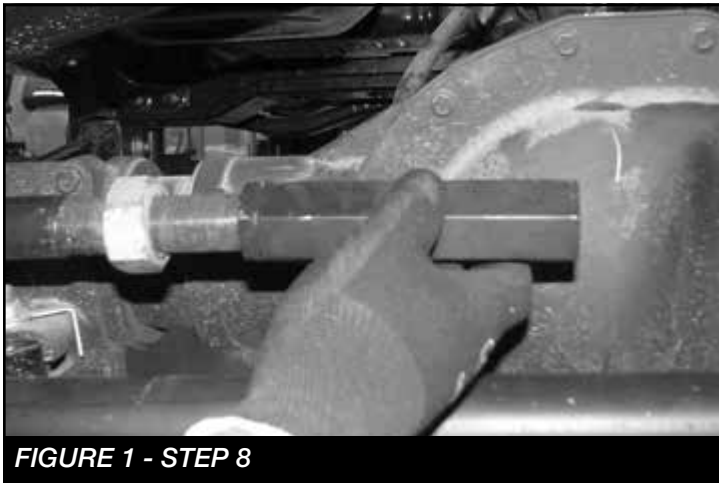

9. Using a die grinder remove the flat nonthreaded section from both ends of the drag link. This will allow you to rotate the drag link and line it up with the pitman arm. **SEE FIGURES 2-4**

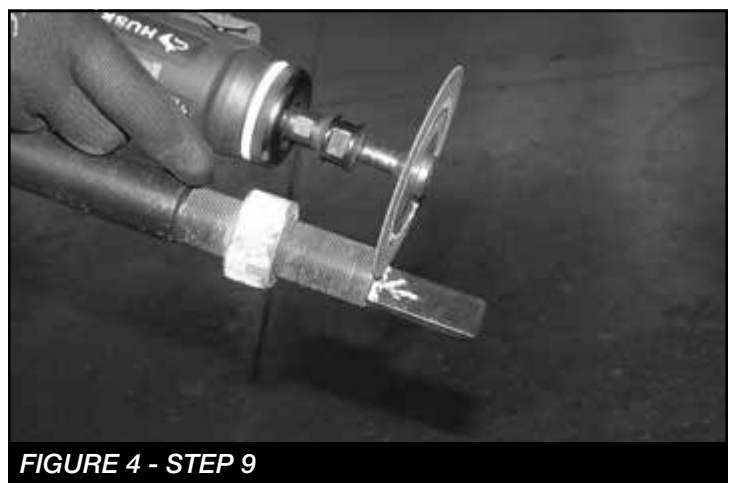

10. Reassemble the drag link and connect it to the new pitman arm. **SEE FIGURE 5**

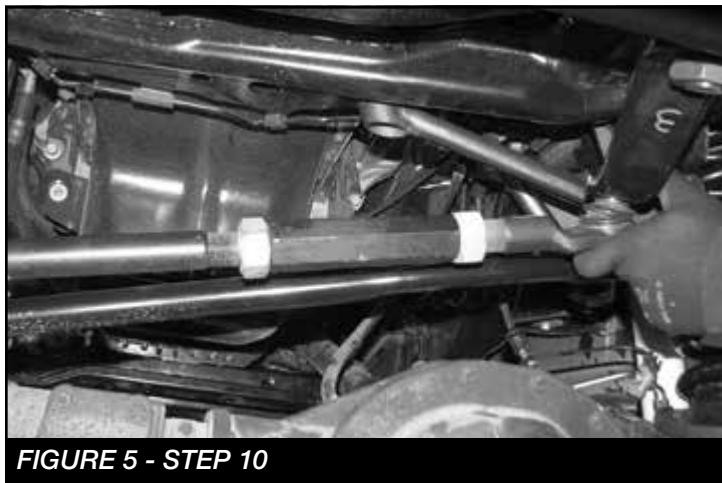

FIGURE 5 - STEP 10

11. Torque the drag link to 83 ft-lbs.
12. Remove the track bar from the frame side of the vehicle.
13. Locate the FT44236BK track bar bracket and M18-2.5 x 90mm bolt.
14. Slide the track bar bracket into the factory mount and insert the M18 bolt into the factory pivot hole. **SEE FIGURE 6**

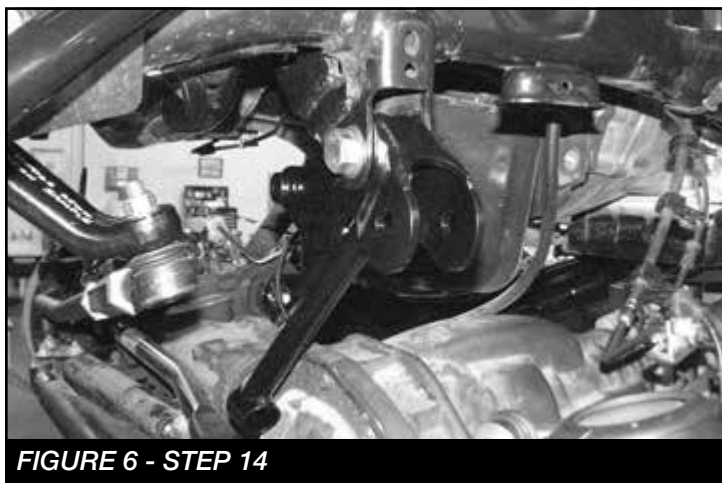

FIGURE 6 - STEP 14

15. Rotate the bracket up until the end of the bracket is flush with the crossmember under the motor.
16. Using the Fabtech bracket as a guide, mark the factory mount for the upper driver side mounting hole.

17. Swing the bracket back out of the way. Using a 1/2" drill bit, drill out the marked hole. **SEE FIGURE 7**



FIGURE 7 - STEP 17

18. Locate one FT44246 sleeve and two 1/2"-13 x 1-1/2" bolts, nuts and washers.
19. Rotate the track bar bracket back into place and bolt together using 1/2"-13 x 1-1/2" bolt and the sleeve. **SEE FIGURES 8-9**

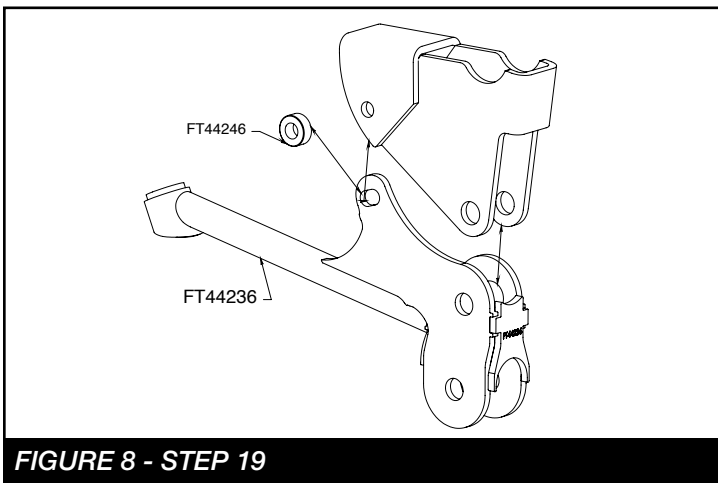

FIGURE 8 - STEP 19



FIGURE 9 - STEP 19

20. Using the Fabtech bracket as a guide, drill a 1/2" hole in the cross member under the motor. Next, mount using 1/2"-13x1.5" and washer. **SEE FIGURE 10**



FIGURE 10 - STEP 20

21. Remove the factory coil springs and lower rubber isolators. **SEE FIGURE 11**



FIGURE 11 - STEP 21

- **IF INSTALLING DIRT LOGIC 4.0 COILOVERS REFER TO THE COILOVER CONVERSION INSTRUCTIONS AT THIS TIME.**

22. Locate and remove the factory rubber bump stop. **SEE FIGURE 12**



FIGURE 12 - STEP 22

23. Using a die grinder, grind out the stamped in tabs on the inside of the bump stop housing. **SEE FIGURES 13-14**



FIGURE 13 - STEP 23



FIGURE 14 - STEP 23

24. Locate the FT44243BK driver front bump stop and the FT44135 nut tab.

25. Using a 1/2" drill bit, drill out the hole in the factory crossmember inline with the factory bump stop mount. **SEE FIGURE 15**



FIGURE 15 - STEP 25

26. Slide the bump stop into the factory bump stop mount. Using a 1/2"-13 x 1-1/4" bolt and the FT44135 (nut tab), bolt the bump stop to the crossmember. Torque the 1/2" bolt to 90 ft-lbs. **SEE FIGURES 16-18**
Using the outer tab on the bump stop as a drill guide, drill a 5/16" hole all the way through the factory bump stop mount. **SEE FIGURE 19**



FIGURE 16 - STEP 26

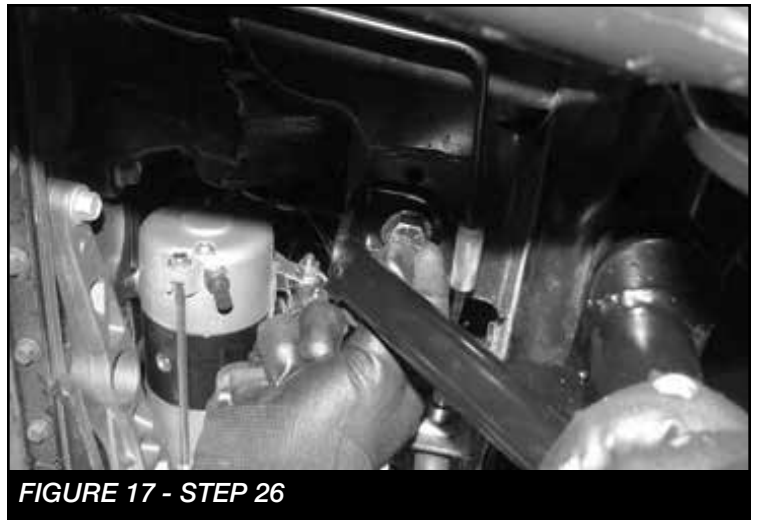

FIGURE 17 - STEP 26



FIGURE 18 - STEP 26

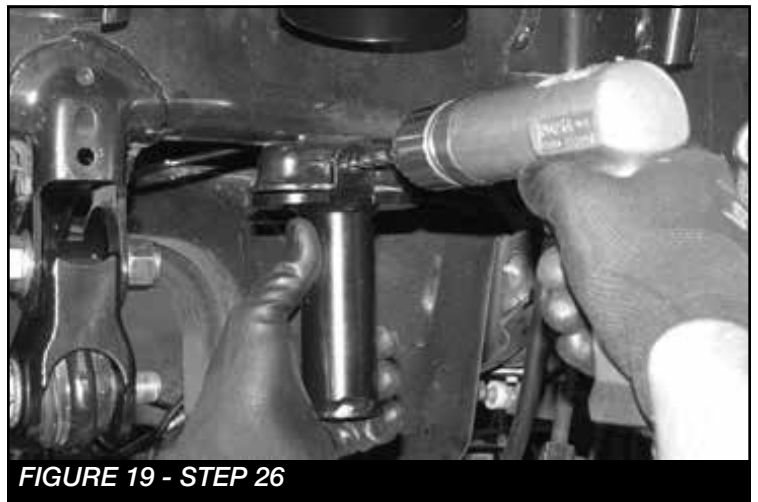

FIGURE 19 - STEP 26

27. Locate a 5/16"-18 x 2-1/2" bolt, nut and washers. Using this bolt, secure the bump stop to the factory bump stop mount and torque to 29 ft-lbs. **SEE FIGURE 20**



FIGURE 20 - STEP 27

28. Locate the FTS88 bump stop pad and thread it into the bottom of the Fabtech bump stop. **SEE FIGURE 21**



FIGURE 21 - STEP 28

29. Repeat steps 2-28 on the passenger side.

30. Secure the front diff. Remove the factory driver and passenger side Radius arm. Retain Hardware. **SEE FIGURES 22-23**



FIGURE 22 - STEP 30



FIGURE 23 - STEP 30

NOTE: SUPPORT THE TRANSFER CASE AT THIS TIME

31. Remove the factory crossmember and skid plate that is mounted between the factory radius arm pockets. Retain Hardware. **SEE FIGURES 24-26**



32. Trim a 2" radius off the inner front radius arm bracket. **SEE FIGURE 27**

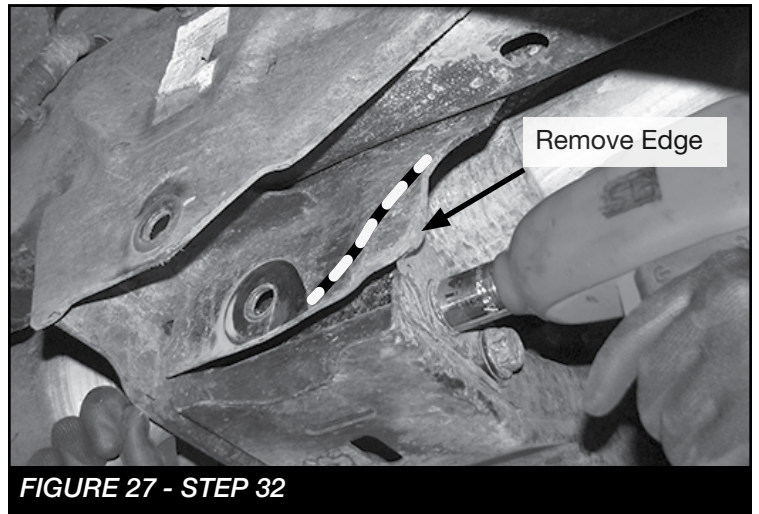

33. Once the crossmember is out. The inner support sleeve will need to be cut out on both sides. **SEE FIGURES 28-29**

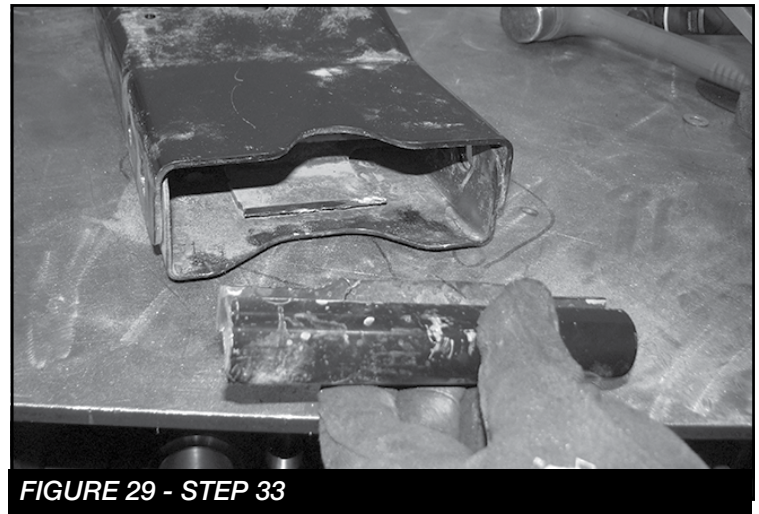

34. Locate and cut out the 4-Link templates on the last pages.

35. Starting on the driver side top of the crossmember. Place the correct template on the crossmember so the edge of the template lines up to the factory edge on the crossmember. Mark for cutting. Do the same with the Driver side bottom. Follow the mark around the side and connect with the mark on the top. **SEE FIGURES 30-31**



FIGURE 30 - STEP 35



FIGURE 31 - STEP 35

36. Carefully cut the crossmember where you made the marks. Sand to a smooth edge. **FIGURE 32** shows what the driver side should look like when complete.



FIGURE 32 - STEP 36

37. Moving to the passenger side of crossmember. Place the cut out templates on the crossmember and mark for cutting. **SEE FIGURES 33-34**



FIGURE 33 - STEP 37



FIGURE 34 - STEP 37

38. Carefully cut the crossmember where you made the marks. Sand to a smooth edge. **FIGURE 35** shows what the passenger side should look like when complete.



FIGURE 35 - STEP 38

39. Locate the factory driver side crossmember frame mount. On the front side only trim 1/2" off the bottom like shown. **SEE FIGURES 36-37**

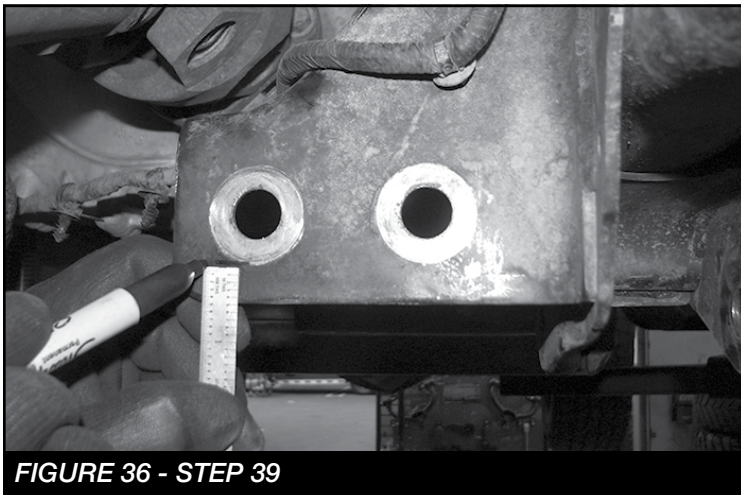

FIGURE 36 - STEP 39

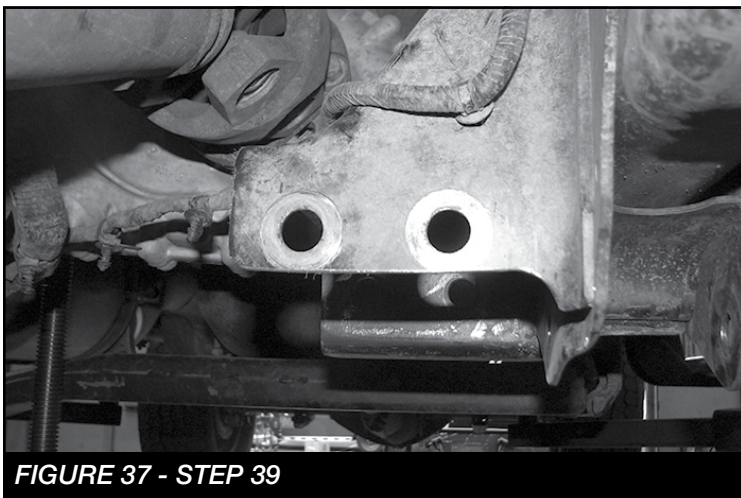

FIGURE 37 - STEP 39

40. Locate FT44300BK (4-Link Driver Bracket), starting on the driver side. Install the bracket like shown below using the 5/8"x 1-3/4" hardware and 3/4"x 1-1/4" hardware from Bag 5 in the hardware kit. Leave loose. **SEE FIGURES 38-39**

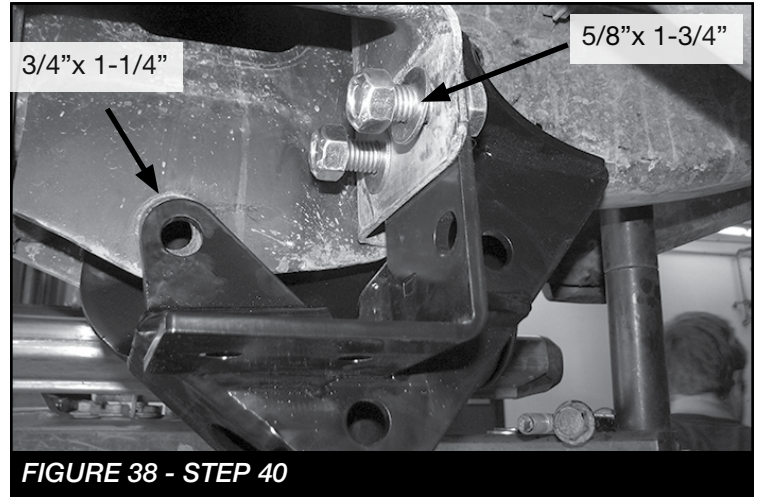

FIGURE 38 - STEP 40

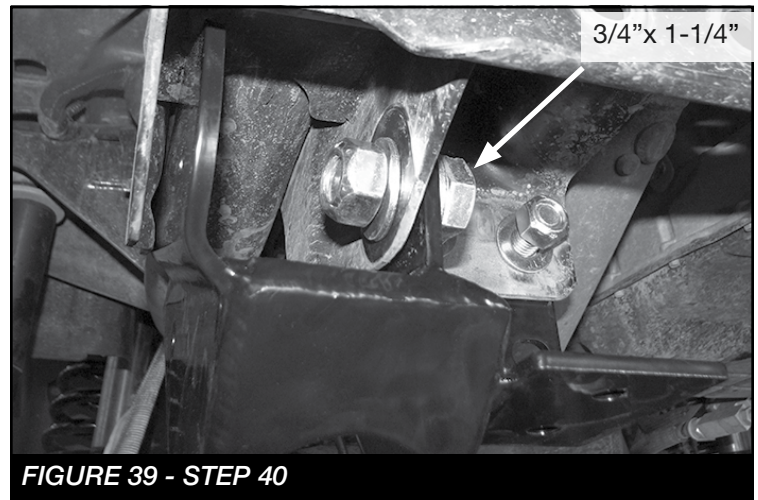

FIGURE 39 - STEP 40

41. From Bag 5, Locate the 3/4"-10 X 2" Bolt, 4 washers and nut. **NOTE: When installing the 3/4" bolt insert 2 washers between the factory bracket and the new Fabtech 4-link bracket.** Leave loose. **SEE FIGURE 40**

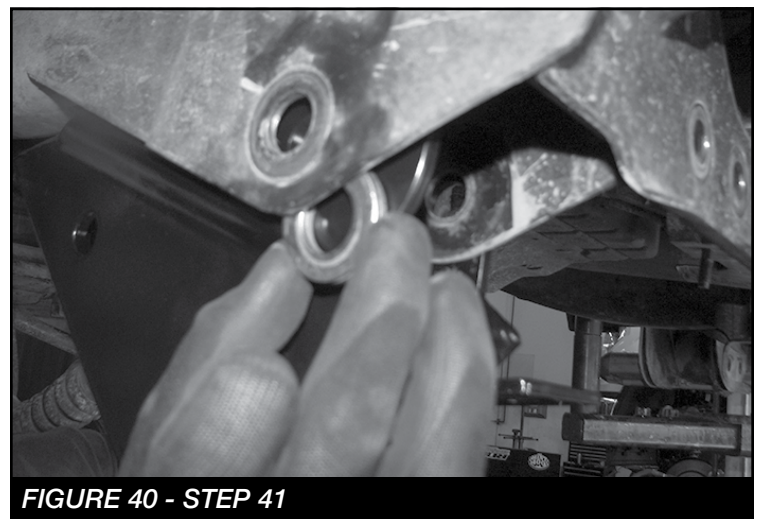

FIGURE 40 - STEP 41

42. Locate FT44324 (Nut Tab) and 7/16" X 1-3/4" bolt and washers. Insert the nut tab through the hole on the frame and install the 7/16" bolt and washers. Torque to 83 ft-lbs. Torque the hardware installed on the previous steps to the below specifications. **SEE FIGURES 41**



FIGURE 41 - STEP 42

- 5/8" - 254 ft-lbs
- 3/4" - 450 ft-lbs
- **REPEAT STEPS 39-42 ON PASSENGER SIDE**

43. Locate FT44318BK (Crossmember Back Plate) and 5/8" Hardware. Install the factory crossmember like shown in **FIGURES 42-44** using the FT44318BK bracket, 5/8" hardware and 1 of the factory bolts. Torque to 254 ft-lbs.

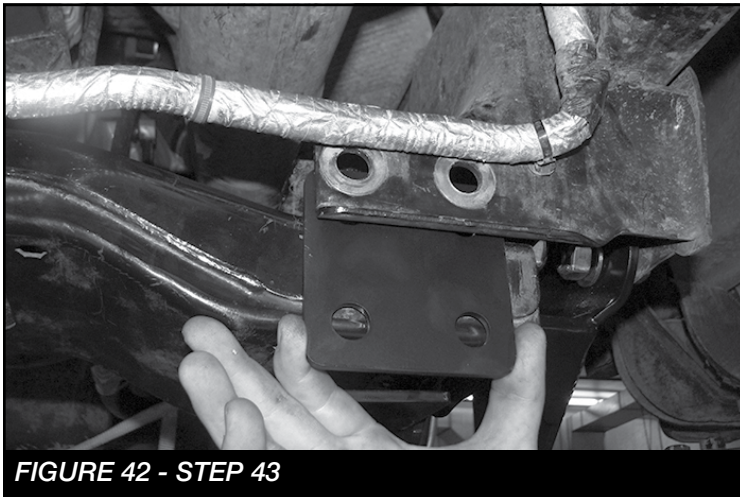

FIGURE 42 - STEP 43

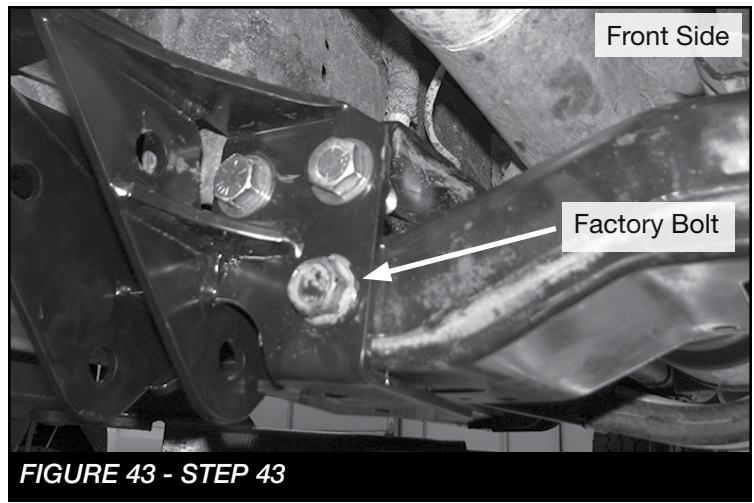

FIGURE 43 - STEP 43

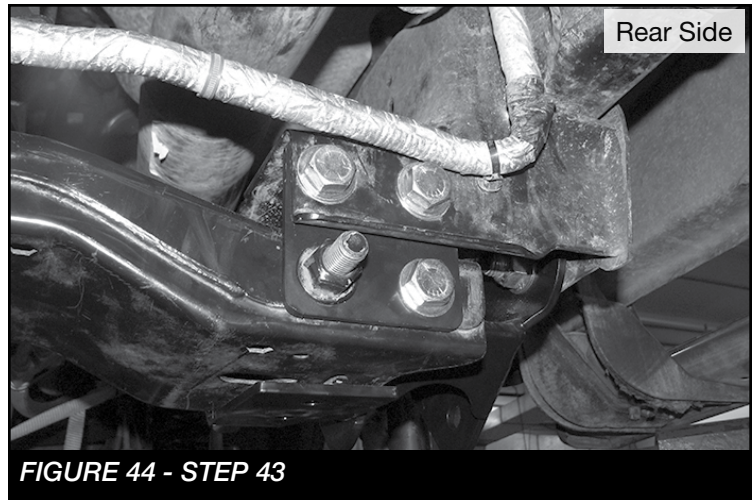

FIGURE 44 - STEP 43

44. Using a 17/32" drill bit. Drill 4 total holes, 2 on the driver side and 2 on the passenger side through the crossmember using the holes in the brackets as guides. **SEE FIGURE 45**

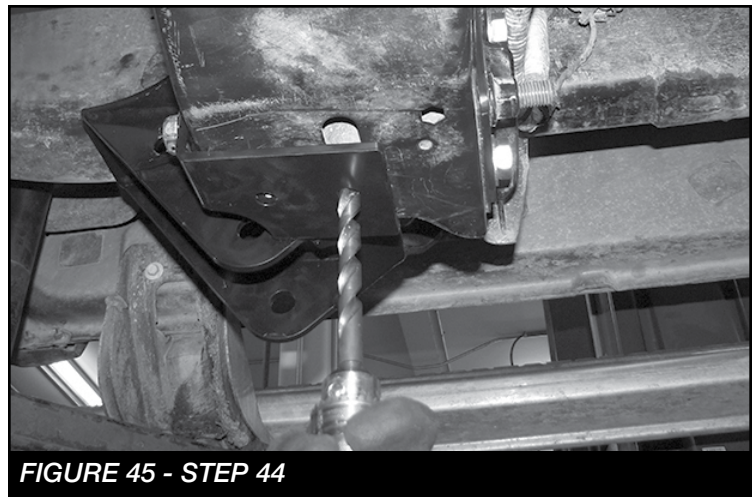

FIGURE 45 - STEP 44

45. Starting with the driver side locate FT44223 (nut tab) (2) 1/2-13 X 1-1/2", washers and (1) 1/2" C-lock nut. **NOTE: The nut tab will be used towards the front of the vehicle.** Torque to 90 ft-lbs. **SEE FIGURE 46**



FIGURE 46 - STEP 45

46. Next for the passenger side locate FT30182 (nut tab) (2) 1/2-13 X 1-1/2", washers and (1) 1/2" C-lock nut. Torque to 90 ft-lbs. **SEE FIGURE 47**

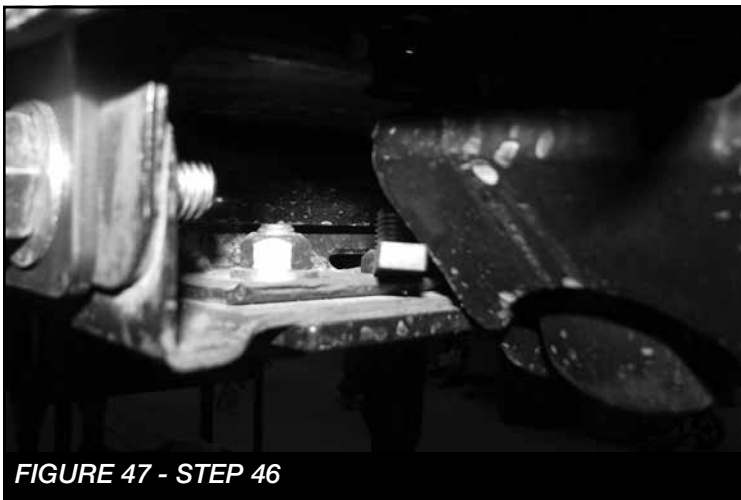

FIGURE 47 - STEP 46

47. Locate and install FT44302 (Outer misalignment spacer) and FT103 (Inner misalignment spacer) onto the new 4-link arms. Install the new arms with the provided 3/4" x 5" bolts and hardware. Re-use the factory hardware for the axle side. Torque to 317 ft-lbs. **SEE FIGURES 48-50**

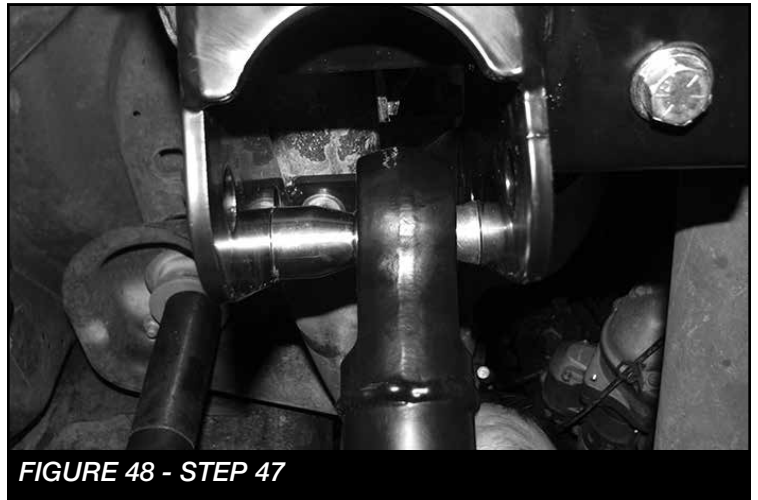

FIGURE 48 - STEP 47



FIGURE 49 - STEP 47



FIGURE 50 - STEP 47

- **Modify the lower H yoke on the front drive shaft as shown on the last page of these instructions. After complete reassembly of the front drive shaft, reinstall it using the original hardware and torque all fasteners to factory specs.**

48. Locate the factory rear crossmember. Remove and discard the exhaust rubber isolator and bracket from the crossmember. Next, with assistance remove the 6 bolts that holds the crossmember on the frame and lower the crossmember to the bottom factory holes. **NOTE: Only 3 bolts will be used to re-attach the crossmember. SEE FIGURE 51-52**

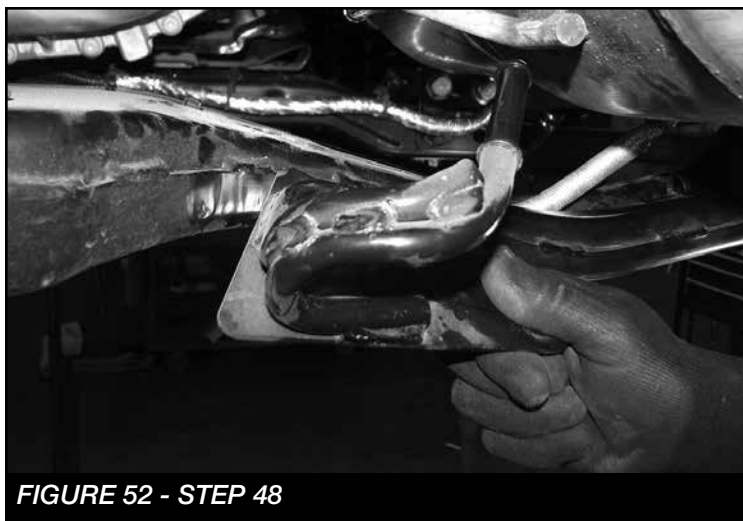

49. Locate the FT44245 Brake line extension, FT44258 nut tab and two 1/4"-20 x 1" bolts. Attach the brake line extension to the axle using one bolt and the nut tab. Attach the factory brake line bracket to the Fabtech extension. Torque to 10 ft-lbs. Repeat this step on the passenger side. **SEE FIGURES 53**



50. Reconnect the factory sway bar. Torque to 29 ft-lbs.

- **REAR SUSPENSION**

51. Jack up the rear end of the vehicle and support the frame rails with jack stands and remove wheels and tires. Remove the rear driver and passenger inner fender liners. **SEE FIGURE 54**



FIGURE 54 - STEP 51

52. Disassemble the rear track bar from the axle side and keep hardware for re-installation. Remove and discard factory sway bar end links and shocks, save lower shock hardware for re-installation. Slowly lower the rear axle and remove and save the rear factory springs and rubber isolators for re-installation. Remove bump stops and hardware from the vehicles frame and keep for re-installation.

53. Locate the hole on the front side of the rear drivers side axle bump stop pad. Drill out this hole to 7/8". **SEE FIGURES 55-56**



FIGURE 55 - STEP 53

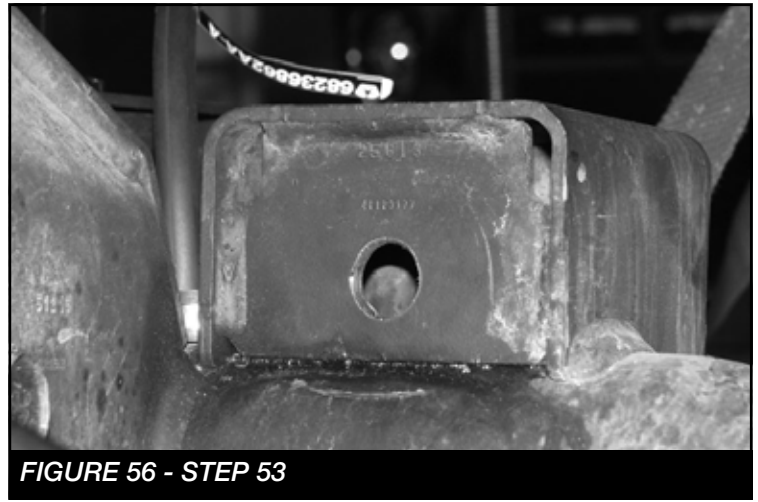

FIGURE 56 - STEP 53

54. Next, on the rear side of the same bump stop pad. Remove the factory brake line bracket and relocate it 3/4"- left and 1-1/4" down using a 17/64" bit. Drill another 17/64" hole 5/8" below to allow the factory bracket to set in. **NOTE: ONLY DRILL THROUGH BUMP STOP PAD, DRILLING TO FAR WILL RESULT IN DAMAGE TO AXEL TUBE. SEE FIGURES 57-58**



FIGURE 57 - STEP 54

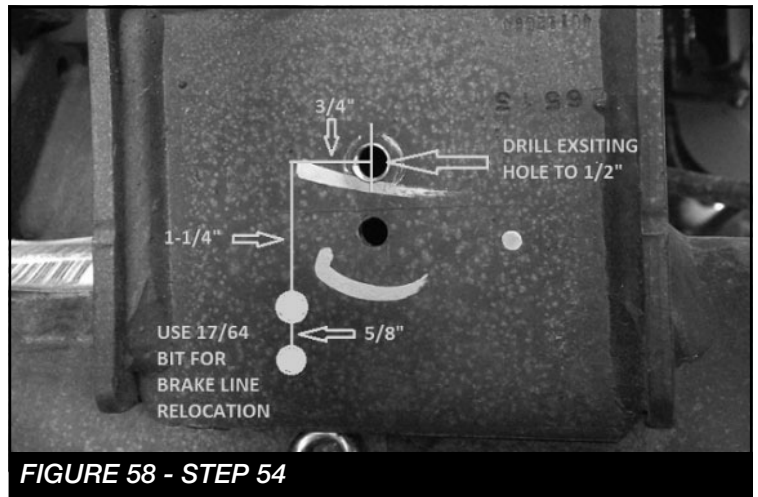

FIGURE 58 - STEP 54

55. Next, using a 1/2" bit, drill the old brake line bracket hole to allow for the new track bar support bracket in a future step. **SEE FIGURE 59**



FIGURE 59 - STEP 55

56. Locate the FT44269BK rear track bar support bracket. TRIMMING MAY BE REQUIRED TO INSTALL THE NEW FT44269BK REAR TRACK BAR SUPPORT BRACKET. **SEE FIGURE 60**

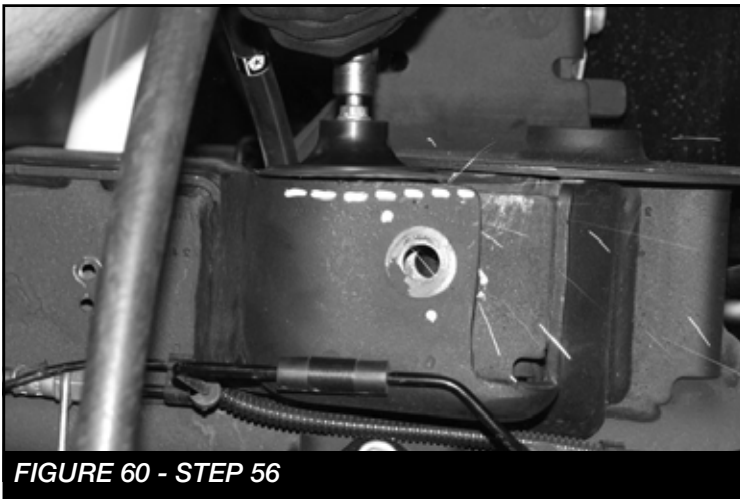

FIGURE 60 - STEP 56

57. Install the FT44269BK using the factory track bar bolt. Mark holes for drilling on the factory track bar bracket. Remove the bolt and drill out the hole on the factory track bar bracket using a 1/2" drill bit. **SEE FIGURES 61-63**



FIGURE 61 - STEP 57

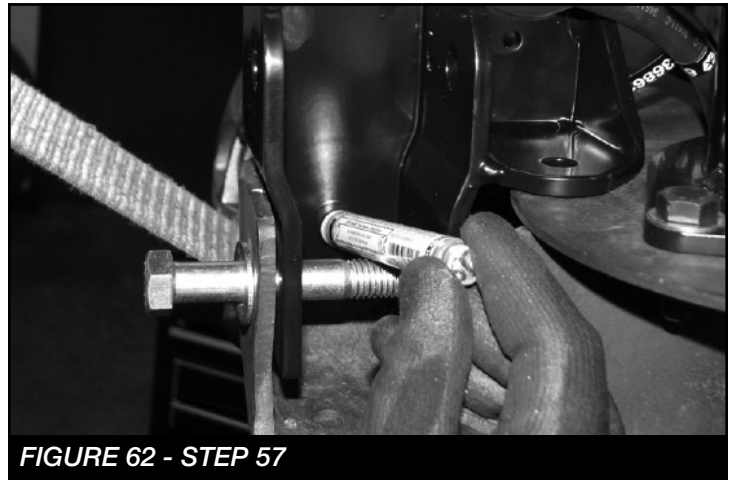

FIGURE 62 - STEP 57



FIGURE 63 - STEP 57

58. Install the supplied 1/2"-13x 2-1/4" bolt, nut, washers and FT606 sleeve as shown below. **DO NOT TIGHTEN.**
SEE FIGURES 64-65

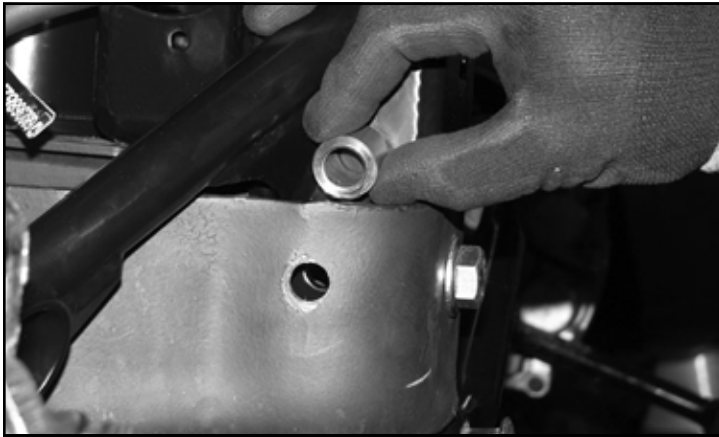

FIGURE 64 - STEP 58

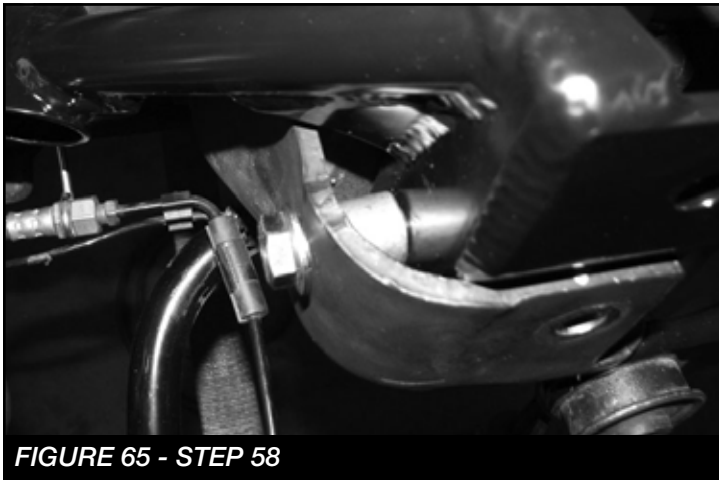

FIGURE 65 - STEP 58

59. Install the factory track bar pivot bolt and hardware along with FT605 Sleeve. Torque to 160 ft-lbs. Next, torque the 1/2" bolt on the same bracket to 127 ft-lbs.
SEE FIGURES 66-67

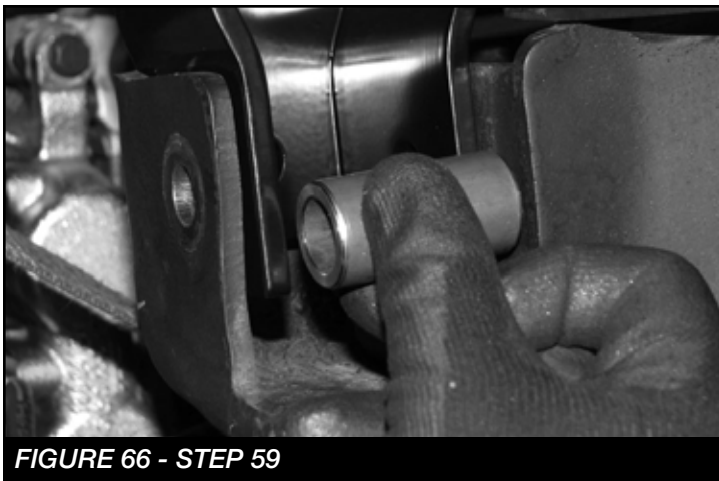

FIGURE 66 - STEP 59

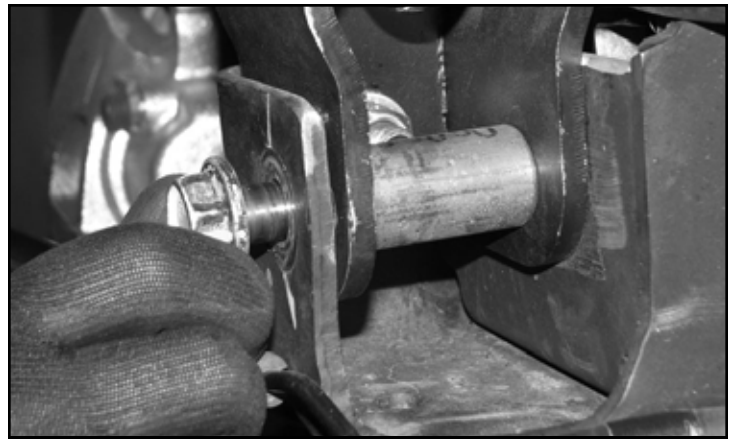

FIGURE 67 - STEP 59

60. Locate FT44270 nut tab, 1/2"-13x 1-1/4" bolt and washer and install into the track bar support bracket through the bump stop pad. Torque to 127 ft-lbs.
SEE FIGURES 68-70



FIGURE 68 - STEP 60



FIGURE 69 - STEP 60



FIGURE 70 - STEP 60

61. Using a 7/16" drill bit, drill through the existing hole on the track bar bracket into the top of the spring perch.

SEE FIGURE 71



FIGURE 71 - STEP 61

62. Locate and install the supplied 7/16"-14x 1-1/4" bolt, washer and FT50184 Track Bar Support Nut Tab. Torque to 83 ft-lbs. **SEE FIGURES 72-73**

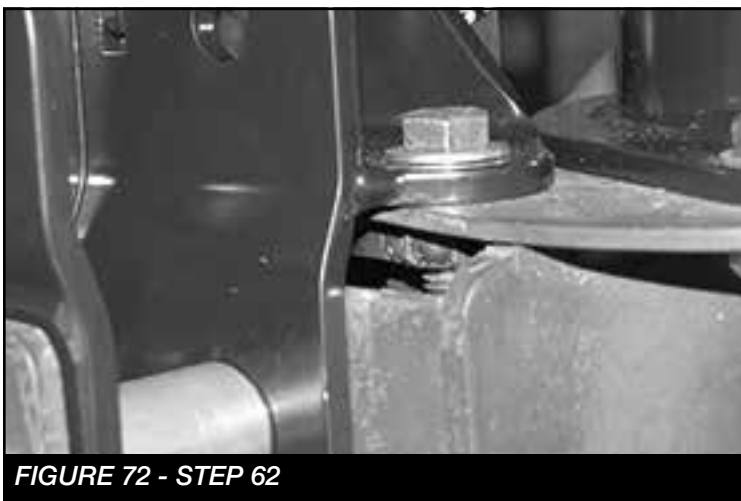

FIGURE 72 - STEP 62



FIGURE 73 - STEP 62

63. Locate the supplied 1/4"-20x 1" bolt, nut, washers and FTCLAMP-LB10 rubber cushioned clamp and install on the rear axle breather tube, mounting it to the hole provided on the new track bar bracket. Torque to 14 ft-lbs. **SEE FIGURE 74**

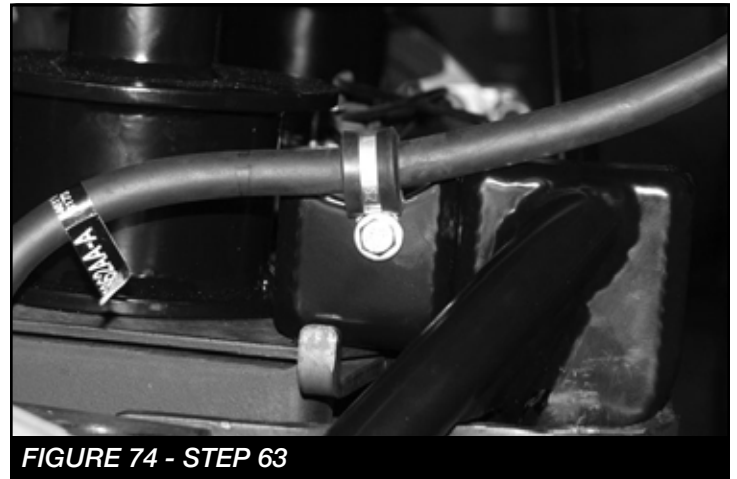

FIGURE 74 - STEP 63

64. Locate the FT44268BK rear bump stop spacer and supplied 7/16"-14x 1-1/4" bolts, nuts, and washers. Install the FT44268BK spacer with the factory bolts that were removed during disassembly. Then, install the factory bump stop onto the spacer bracket with the supplied 7/16" hardware. Torque to 58 ft-lbs. **SEE FIGURE 75**

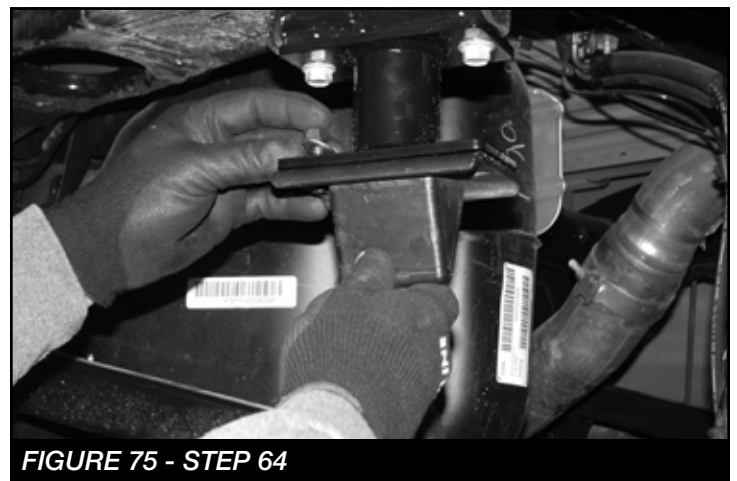

FIGURE 75 - STEP 64

65. Locate and Install (FT44279BK) Fabtech rear spring using the factory rubber isolators as shown. **SEE FIGURE 76**

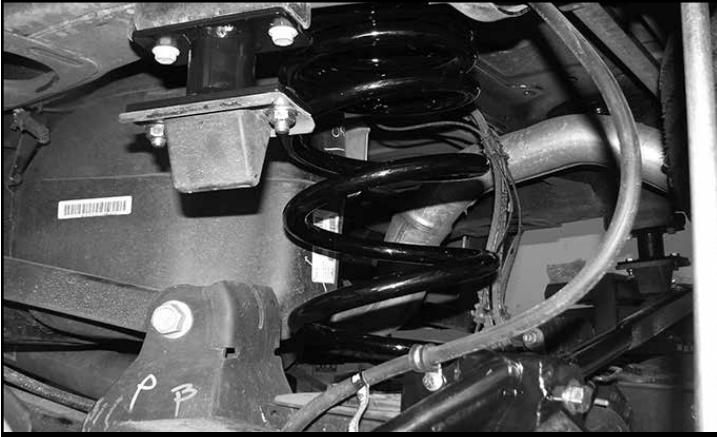

FIGURE 76 - STEP 65

66. Locate the supplied 9/16"-18x 3-1/2" bolt, nut and washers and install the rear track bar into the new location. Torque to 184 ft-lbs. **SEE FIGURE 77**

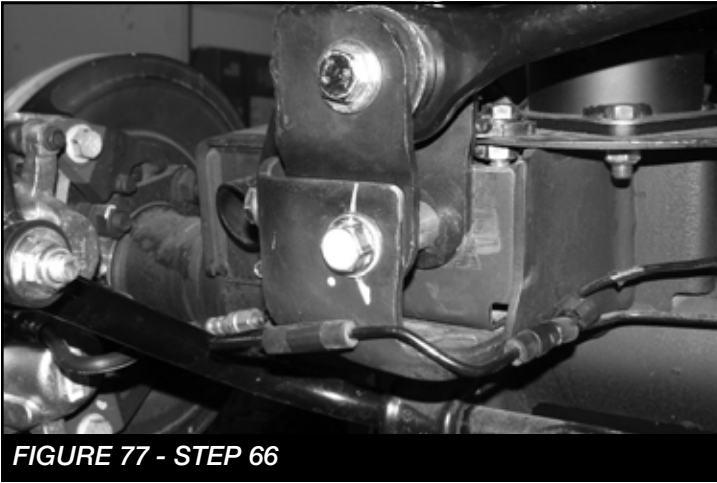

FIGURE 77 - STEP 66

67. Locate the FT1599-2-4 (5" zinc sway bar links) and supplied M12-1.75 x 70mm bolts, Nylok nuts and washers. Install the supplied bushings and sleeves. **SEE FIGURES 78-79**

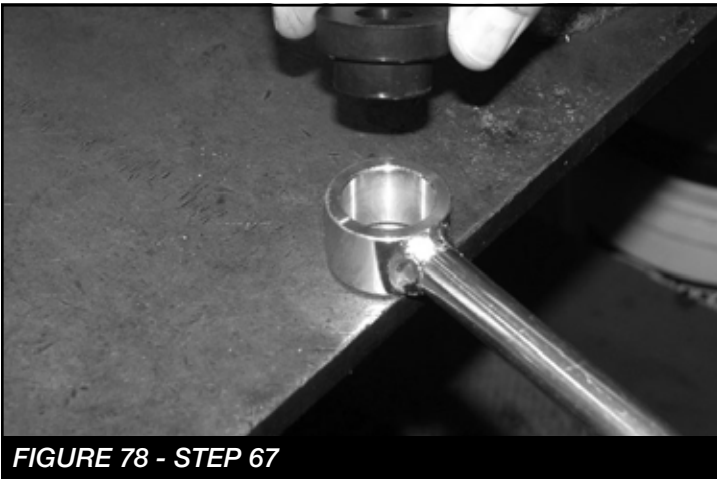

FIGURE 78 - STEP 67

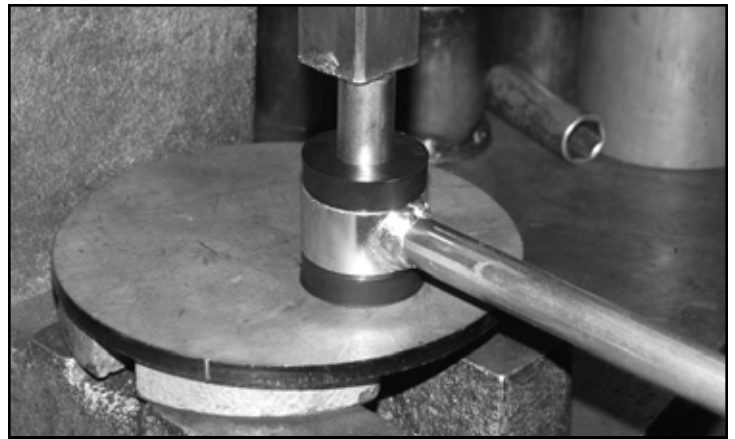

FIGURE 79 - STEP 67

68. Install the new end links with the supplied M12-1.75 x 70mm bolts, Nylok nuts and washers and torque to 100 ft-lbs. **SEE FIGURES 80-81**

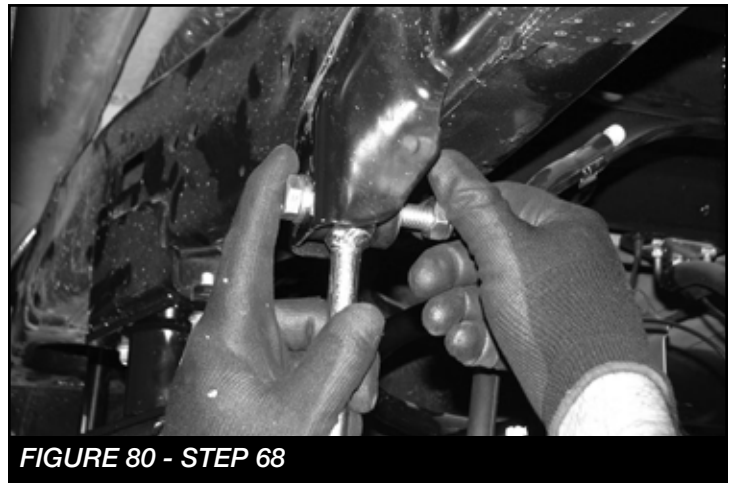

FIGURE 80 - STEP 68

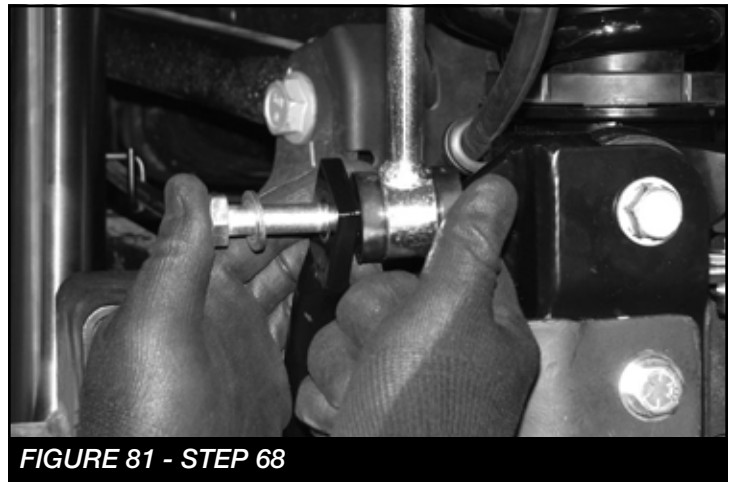

FIGURE 81 - STEP 68

69. Locate the rear shocks that were supplied with the kit: Part numbers vary between kits. FTS7188 (Performance), FTS6344 (Stealth) or FTS811041 (Dirt Logic 2.25 Shock)
70. Press the supplied sleeve into the lower bushing and install the rear shocks with the supplied washers and bushings. Next, torque the upper nut to 14 ft-lbs and the lower to 37 ft-lbs. **SEE FIGURES 82-83**

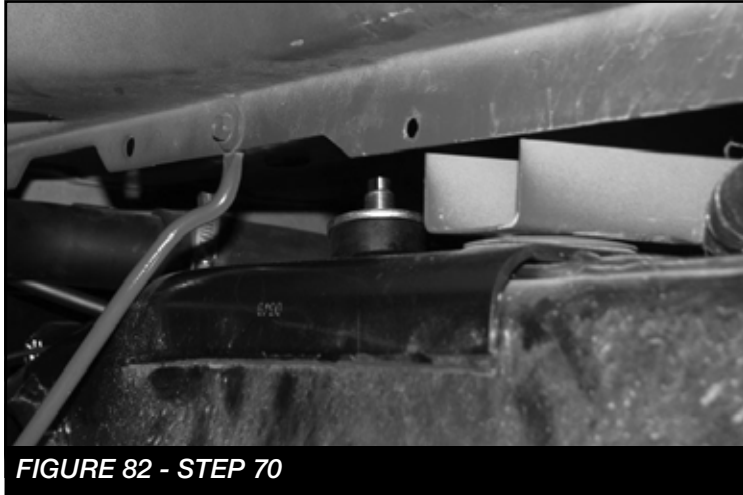

FIGURE 82 - STEP 70

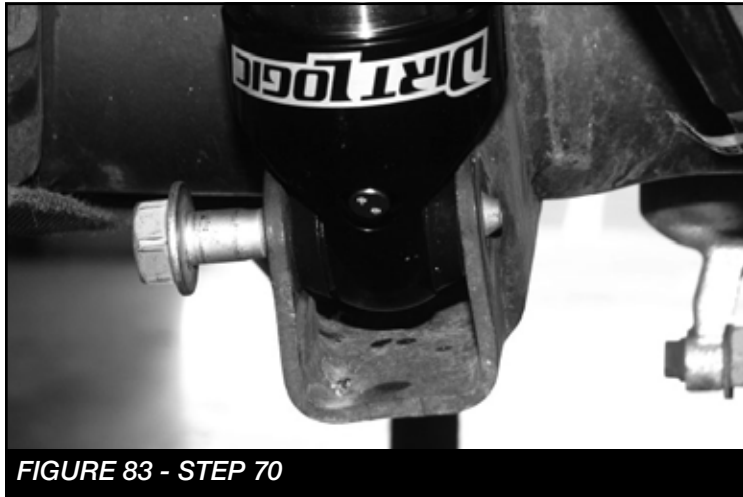

FIGURE 83 - STEP 70

71. Re-Install both front and rear inner fender liners.
72. Install tires and wheels and torque lug nuts to wheel manufacturer's specifications. Turn front tires left to right and check for appropriate tire clearance. **Note - Some oversized tires may require trimming of the front bumper & valance.**

73. Check front end alignment and set to factory specifications. Readjust headlights.
74. Recheck all bolts for proper torque.
75. Recheck brake hoses, ABS wires and suspension parts for proper tire clearance while turning tires fully left to right.
76. Check the fluid in the front and rear differential and fill if needed with factory specification differential oil. **Note - some differentials may expel fluid after filling and driving. This can be normal in resetting the fluid level with the new position of the differential/s.**
77. Install Driver Warning Decal. Complete product registration card and mail to Fabtech in order to receive future safety and technical bulletins on this suspension.

Vehicles that will receive oversized tires should check ball joints, uniballs and all steering components every 2500-5000 miles for wear and replace as required.

RE-TORQUE ALL NUTS, BOLTS AND LUGS AFTER 50 MILES AND PERIODICALLY THEREAFTER.

For technical assistance call: **909-597-7800**

- Product Warranty and Warnings -

Fabtech provides a Limited Lifetime Warranty to the original retail purchaser who owns the vehicle, on which the product was originally installed, for defects in workmanship and materials.

The Limited Lifetime Warranty excludes the following Fabtech items; bushings, bump stops, ball joints, tie rod ends, limiting straps, cross shafts, heim joints and driveshafts. These parts are subject to wear and are not considered defective when worn. They are warranted for 60 days from the date of purchase for defects in workmanship.

Dirt Logic and Performance Coilover take apart shocks are considered a serviceable shock with a one year warranty on leakage only. Service seal kits are available separately for future maintenance. All other shocks are covered under our Limited Lifetime Warranty.

Fabtech does not warrant any product for finish, alterations, modifications and/or installation contrary to Fabtech's instructions. Alterations to the finish of the parts including but not limited to painting, powder coating, plating and/or welding will void all warranties. Some finish damage may occur to parts during shipping, which is considered normal and is not covered under warranty.

Fabtech products are not designed nor intended to be installed on vehicles used in race applications or for racing purposes or for similar activities. (A "RACE" is defined as any contest between two or more vehicles, or any contest of one or more vehicle against the clock, whether or not such contest is for a prize). This warranty does not include coverage for police or taxi vehicles, race vehicles, or vehicles used for government or commercial purposes. Also excluded from this warranty are sales outside of the United States of America.

Installation of most suspension products will raise the center of gravity of the vehicle and will cause the vehicle to handle differently than stock. It may increase the vehicle's susceptibility to a rollover, on road and off road, at all speeds. Extreme care should be taken to operate the vehicle safely at all times to prevent rollover or loss of control resulting in serious injury or death. Fabtech front end Desert Guards may impair the deployment or operation of vehicles equipped with supplemental restraining systems/air bag systems and should not be installed if the vehicle is equipped as so.

Fabtech makes every effort to ensure suspension product compatibility with all vehicles listed on the website, but due to unknown auto manufacturer's production changes and/or inconsistencies by the auto manufacturer, Fabtech cannot be responsible for 100% compatibility, including the fitment of tire and wheel sizes listed. The Tire and Wheel sizes listed in Fabtech's website are only a guideline for street driving with noted fender trimming. Fabtech is not responsible for damages to the vehicle's body or tires. Fabtech is not responsible for premature wear of factory components due to the installation of oversized tires and wheels.

Fabtech's obligation under this warranty is limited to the repair or replacement, at Fabtech option, of the defective product only. All costs of removal, installation or re-installation, freight charges, incidental or consequential damages are expressly excluded from this warranty. Fabtech is not responsible for damages and/or warranty of other vehicle parts related or non related to the installed Fabtech product. This warranty is expressly in lieu of all other warranties expressed or implied. This warranty shall not apply to any product that has been subject to accident, negligence, alteration, abuse or misuse as determined by Fabtech.

Fabtech suspension components must be installed as a complete system including shocks as shown on our website. All warranties will become void if Fabtech parts are combined and/or substituted with other aftermarket suspension products. Combination and/or substitution of other aftermarket suspension parts may cause premature wear and/or product failure resulting in an accident causing injury or death. Fabtech does not warrant products not manufactured by Fabtech.

Depending on the condition of the factory suspension components retained after the installation of a Fabtech suspension not all vehicles may have the same ride stance front to rear as described in the website. The blue color of suspension components shown in all Fabtech photographs are for display purposes only. Majority of all Fabtech components will be black specifically where noted with part numbers ending in BK.

Installation of Fabtech product may void the vehicles factory warranty; it is the consumer's responsibility to check with their local vehicle's dealer for warranty disposition before the installation of the product. Some state laws may prohibit modification of suspension to a vehicle in whole or in part. It is the responsibility of the installer and consumer to consult local laws prior to the installation of any Fabtech suspension product to comply with such written laws.

It is the responsibility of the distributor and/or the retailer to review all warranties and warnings of Fabtech products with the consumer prior to purchase.

Fabtech reserves the right to super cede, discontinue, change the design, finish, part number and/or application of parts when deemed necessary without written notice. Fabtech is not responsible for misprints or typographical errors within the website or price sheet. For the most recent Product Warranty and Warnings visit our website www.fabtechmotorsports.com

4-LINK TEMPLATE

PRINT AT 100% - DO NOT SCALE TO PAGE

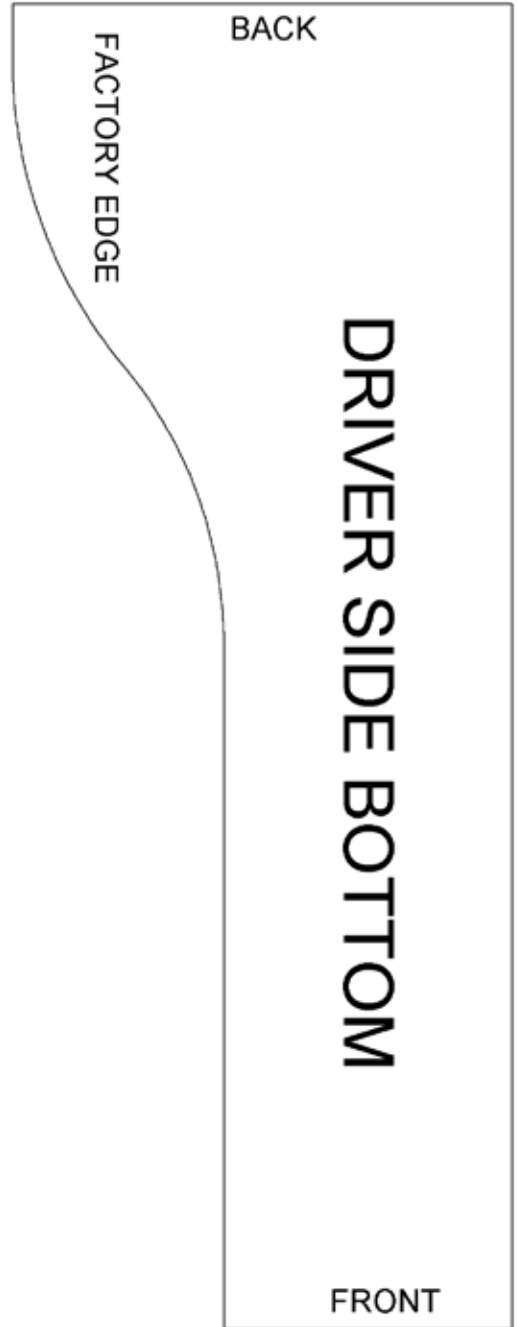
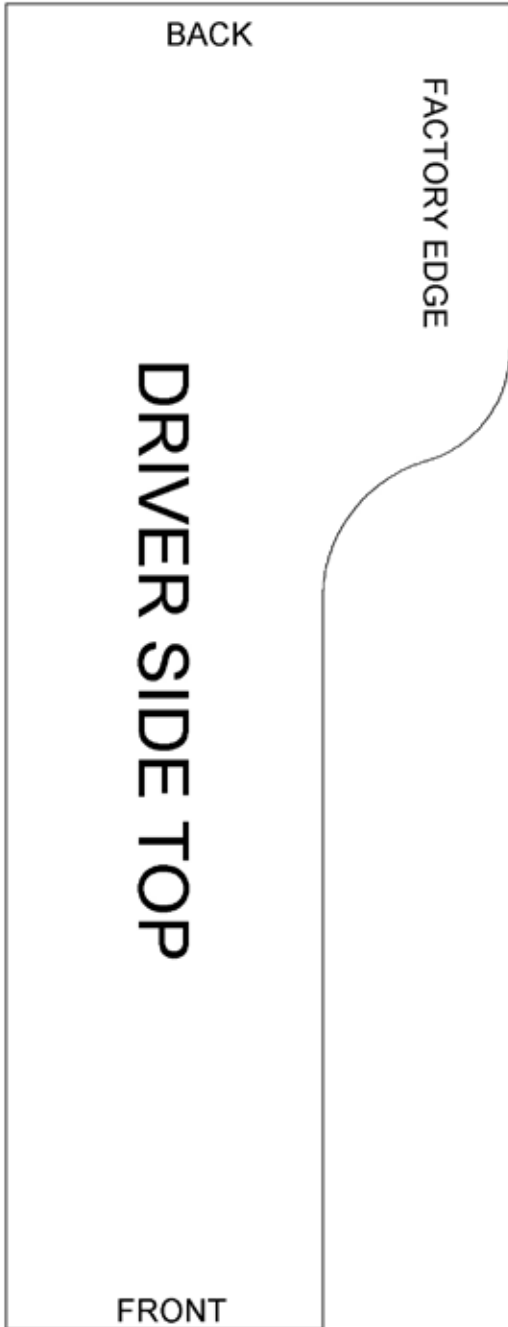

4-LINK TEMPLATE

PRINT AT 100% - DO NOT SCALE TO PAGE

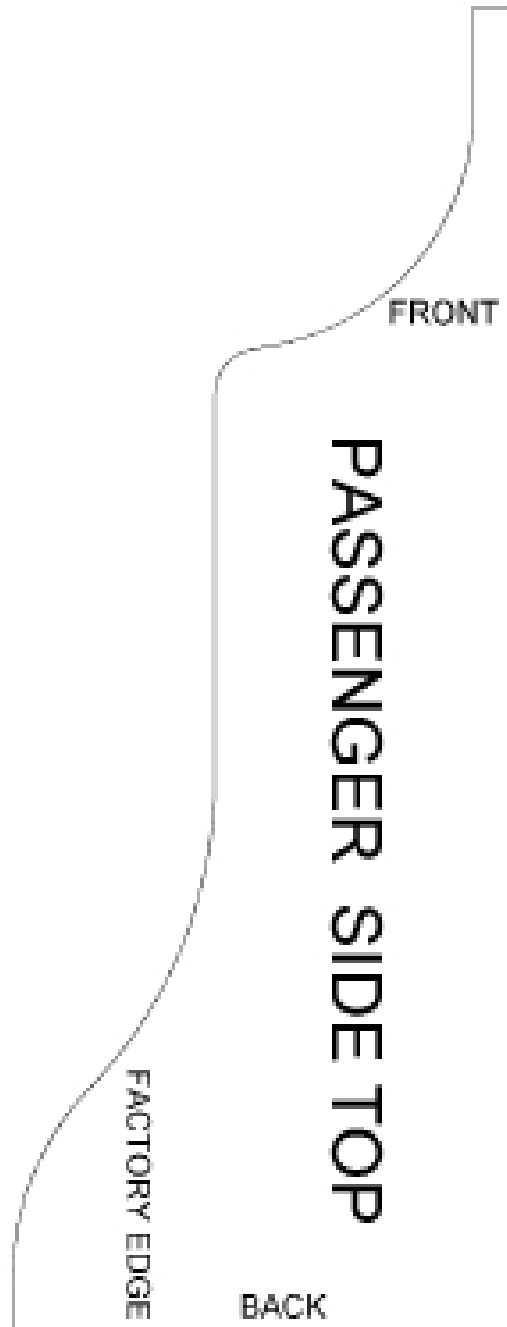
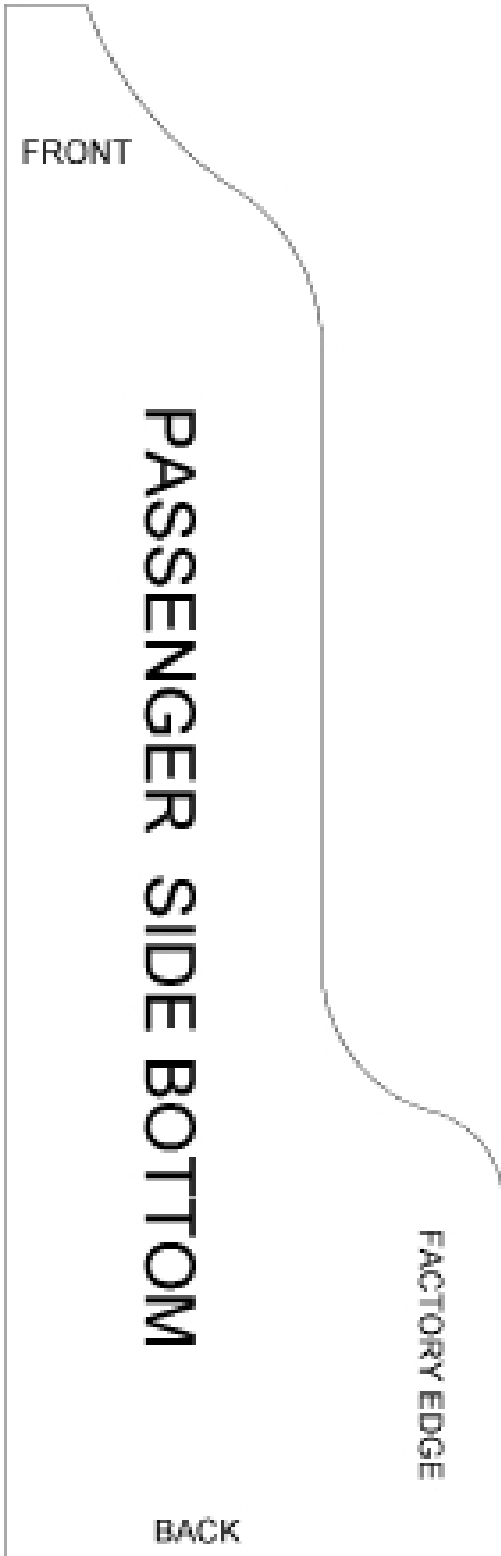



Before

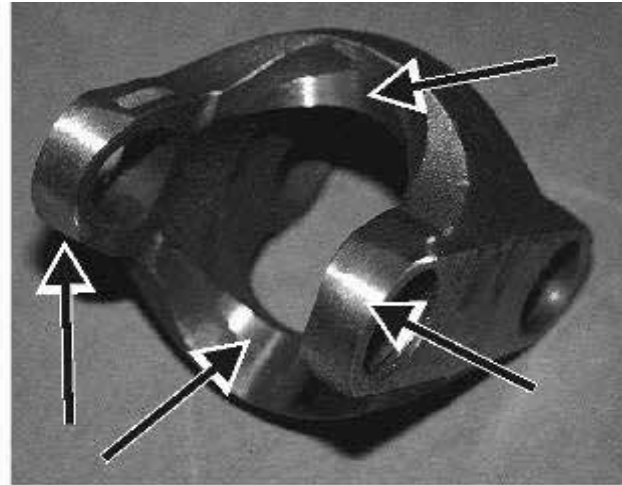

After

Both side of the H Yoke Must be cleared.



Before

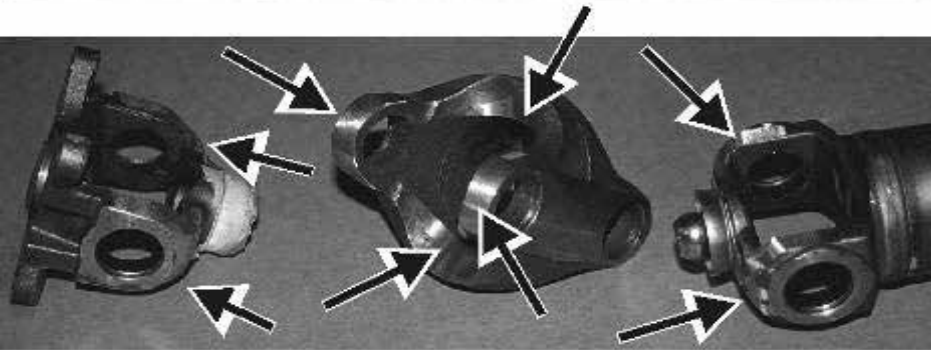

After

Remove material as shown in areas marked with arrows.