



INSTALLATION INSTRUCTIONS



2013-2017 DODGE 1500 4WD 6" BASIC & PERFORMANCE SYSTEMS

FTS23040

FT23040i

Fabtech Motorsports | 4331 Eucalyptus Ave. Chino, CA 91710

Tech Line: 909-597-7800 | **Fax:** 909-597-7185 | **Web:** www.fabtechmotorsports.com

- PARTS LIST -

	FTS23040	COMPONENT BOX 1
1	FT44020	DIFF MOUNT FRONT (PASSENGER)
1	FT44021	DIFF MOUNT OUTER (DRIVER)
1	FT44026	DIFF MOUNT REAR (PASSENGER)
1	FT44207	MOUNT INNER (PASSENGER)
1	FT44204	DIFF MOUNT REAR
2	FT44288	OUTER TIE ROD END
2	FT44073	LOWER SWAY BAR MOUNT
2	FT44075	SWAY BAR END LINK
1	FT44077	HARDWARE KIT
1	FT44078	HARDWARE KIT
1	FT44210	HARDWARE KIT
2	FT44133	SWAY BAR SPACER
2	FT44163BK	REAR UPPER LINK
2	FT44164BK	REAR LOWER LINK
1	FT44226	HARDWARE SUBASSEMBLY
1	FTS44115D	SPINDLE (DRIVER)
1	FTS44115P	SPINDLE (PASSENGER)

	FTS23041	COMPONENT BOX 2
2	FT1599-2-4	5" SWAY BAR LINK
1	FT44357BK	SKID PLATE
1	FT44203	SPACER DRIVE SHAFT
1	FT44358BK	FRONT CROSSMEMBER
1	FT44233BK	REAR CROSSMEMBER
1	FT44166BK	TRACK BAR SUPPORT TUBE
1	FT44187BK	TRACK BAR DROP BRACKET
1	FT44188BK	REAR BUMP STOP SPACER (DRIVER)
1	FT44189BK	REAR BUMP STOP SPACER (PASSENGER)
1	FT44191	HARDWARE KIT
1	FT44192	HARDWARE SUBASSEMBLY
2	FT44294BK	REAR COIL

	FTS23038	COMPONENT BOX 3
2	FT44209BK	6" SHOCK SPACER

	FT44226	HARDWARE SUBASSEMBLY
2	FT23040I	INSTRUCTIONS
2	FT50232	SLEEVE 1.000 X .531 X .450 (DIESEL)
2	FT44205	SLEEVE 1.000 X .563 X .665 (NON DIESEL)
1	FT44071	BRAKELINE MOUNT (DRIVER)
1	FT44072	BRAKELINE MOUNT (PASSENGER)
1	FT90084	SWAY BAR BUSHING KIT
2	FT90111	BUSHING KIT
1	FTAS16	DRIVER WARNING DECAL
2	FTLOCK	THREAD LOCKING COMPOUND 1 MIL
1	FTREGCARD	REGISTRATION CARD
4	FTS43	MISALIGNMENT 3/4" CLEAR ZINC
2	FTS98003	3/4" ROD END L.D.

	FT44192	HARDWARE SUBASSEMBLY
8	FT1004	SWAY BAR LINK BUSHING HALF
1	FT189	SLEEVE 1.000 X .625 X 1.7
4	FT404739	SLEEVE OD 0.62 ID 12MM L.1.48
1	FT44045	TRACK BAR NUT TAB CLEAR ZINC
1	FT44069	IMPACT MOUNT NUT TAB (DRIVER)
1	FT44070	IMPACT MOUNT NUT TAB (PASSENGER)
2	FT50136	NUT TAB LOWER MOUNT

- PARTS LIST CONTINUED -

	FT44191 - HARDWARE KIT	LOCATION
4	M12-1.75 X 70MM HEX C/S CL.10.9	FRONT SWAY BAR
4	M12 SPLIT LOCK WASHER	
4	M12 FLAT WASHER	
4	M12-1.75 X 70MM HEX C/S CL.10.9	REAR SWAY BAR
8	M12 FLAT WASHER	
4	M12-1.75 C - LOCK	
1	M14-2.0 X 100MM HEX HD C/S CL 10.9	TRACK BAR
2	14MM FLAT WASHER	
1	M14-2.0 GR C CROWNLOCK NUTS	
1	5/16-18 X 1" HEX	E-BRAKE BRACKET
2	5/16" SAE FLAT WASHER	
1	5/16-18 C - LOCK NUTS	
6	7/16-14 X 1 1/2 HEX HD C/S GRADE 8	BUMPSTOPS
10	7/16" SAE FLAT WASHER	
5	7/16-14 C -LOCK	
2	1/2-13 X 1" HEX HEAD	TRACK BAR BRACKET
2	1/2" SAE FLAT WASHER	
1	3/4-10 X 3 HEX HEAD	TRCK BAR SUPPORT TUBE
2	3/4" SAE FLAT WASHER	
1	3/4-10 C - LOCK	
8	1/4-28 TAPERED THRD STRAIGHT GREASE FITTING	LINK ARMS
1	LOCTITE #14500 2ML TUBE RED	
6	8" CABLE TIE BLACK	

	FT44210 - HARDWARE KIT	LOCATION
3	M12-1.75 X 35MM HEXT BOLT	FRONT DIFF/ REAR MOUNT
3	M12-1.75 GR C CROWNLOCK NUT	
3	1/2-13 X 1-3/4 HEX BOLT G8	REAR DIFF MOUNT
3	12 1/2 SAE WASHER G8	
3	1/2-13 C- LOCK NUT	
4	M12-1.75 X 55MM HEX BOLT G10.9	DRIVESHAFT SPACER
4	M12 LOCK WASHER	
4	M12 FLAT WASHER	
6	12 1/2 SAE WASHER	FRONT DIFF MOUNT

	FT44077 - HARDWARE KIT	LOCATION
4	M12-1.75 X 45MM HEX HEAD 10.9	DRIVE SHAFT SPACER
4	M12 FLAT WASHER	
6	7/16-14 GRADE C - LOCK	SHOCK SPACER
6	7/16" SAE FLAT WASHER	
4	1/2-13 X 2 3/4" HEX HEAD	PASSENGER DIFF MOUNT
8	1/2" SAE FLAT WASHER GRADE 8	
4	1/2-13 GRADE C LOCK NUT	
4	1/2-13 X 2 1/2" HEX HEAD	FRONT DIFF MOUNT
8	1/2" SAE FLAT WASHER GRADE 8	
4	1/2-13 GRADE C OVAL LOCK NUT	
3	9/16-12 X 2 1/4 HEX HEAD	REAR PASS DIFF MOUNT
3	9/16" SAE FLAT WASHER	
3	9/16-12 C LOCK NUTS	
4	5/8-11 X 5 1/2 HEX	CONTROL ARM PIVOT BOLT
8	5/8" SAE FLAT WASHER	
4	5/8-11 GRADE C LOCK NUT	

	FT44078 - HARDWARE KIT
6	1/4" SAE FLAT WASHER ZINC PLATED
2	1/4-20 GR C CROWNLOCK NUT
4	1/4-20 X 3/4 HEX HD C/S GRADE 5
2	3/8" SAE FLAT WASHER GRADE 8
2	3/8-16 GRADE C CROWNLOCK NUTS
12	7/16" SAE FLAT WASHER GRADE 8
4	7/16" SPLIT LOCK WASHER
4	7/16-14 GRADE C CROWNLOCK NUTS
4	7/16-14 X 1 1/4 HEX HD C/S GRADE 8
4	7/16-14 X 3 1/2 HEX HD C/S GRADE 8
7	1/2" SAE FLAT WASHER GRADE 8
1	1/2" SPLIT LOCK WASHER GRADE 8
3	1/2-13 GRADE C OVAL LOCK NUT
1	1/2-13 X 1 1/4 HEX HD C/S GRADE 8
3	1/2-13 X 2 3/4" HEX HEAD C/S GRADE 8
2	1/2-13 X 3" BUTTON SOCKET CAP SCREW
2	3/4-16 HEX JAM NUT
2	S325-G6 CUSHIONED CLAMP

- TOOL LIST -

Required Tools (Not Included)

Floor Jack, Jack Stands, Torque Wrench, Drill/Drill Bits, Arbor Press or vise, Sawzall, Assorted Metric and S.A.E sockets, and Allen wrenches, Die Grinder w/ Cutoff Wheel and Grinding Wheel, Large Dead Blow Hammer

- PRE-INSTALLATION NOTES -

Read this before you begin installation-

Check all parts to the parts list above before beginning installation. If any parts are missing contact Fabtech at 909-597-7800 and a replacement part will be sent to you immediately.

Read all instructions thoroughly from start to finish before beginning the installation. If these instructions are not properly followed severe frame, driveline and / or suspension damage may occur.

Check your local city and state laws prior to the installation of this system for legality. Do not install if not legal in your area.

Prior to the installation of this suspension system perform a front end alignment and record. Do not install this system if the vehicle alignment is not within factory specifications. Check for frame and suspension damage prior to installation.

The installation of this suspension system should be performed by two professional mechanics.

Use the provided thread locking compound on all hardware.

Do not combine this suspension system with any other lift device or parts.

This suspension must be installed with Fabtech shock absorbers.

WARNING- Installation of this system will alter the center of gravity of the vehicle and may increase roll over as compared to stock.

For technical assistance call: 909-597-7800 or e-mail: info@fabtechmotorsports.com

OEM Wheels and tires cannot be used after the installation of this kit. Larger tire cannot be installed on the OEM wheels.

This suspension system is designed to fit 4WD models only. Will not work with All Wheel Drive (AWD) models.

Rear springs may reduce load carrying capacity.

Will not fit 1500 Mega Cab models.

Will not fit models equipped with factory air-ride suspension.

Verify differential fluid is at manufactures recommended level prior to kit installation. Installation of the kit will reposition the differential and the fill plug hole may be in a different position. (For example, if the manufacture recommends 3 quarts of fluid, make sure the diff has 3 quarts of fluid). Check your specific manual for correct amount of fluid.

Recommend Tires and Wheels:

Use 325/65R18 tire w/ 18x9 wheels w/ 4 1/2" BS w/ minor trimming

Use 35/13.50R18 tire w/ 18x9 wheels w/ 4 1/2" BS w/ minor trimming

Use 35/12.50R20 tire w/ 20x9 wheels w/ 4 1/2" BS w/ minor trimming

- INSTRUCTIONS -

FRONT SUSPENSION

1. Disconnect the negative terminal on the battery.
2. Jack up the front end of the truck and support the frame rails with jack stands. **NEVER WORK UNDER AN UNSUPPORTED VEHICLE!** Remove the front tires.
3. Remove the factory transfer case skid plate and discard.
4. Disconnect the front drive shaft from the differential and discard the hardware. (Do not allow to hang freely)
5. Locate the sway bar end links and disconnect them from the lower control arms and the sway bar. Discard the end links and hardware. Leave the factory sway bar on the truck attached to the frame mounts.
6. Working from the driver side of the vehicle, disconnect the tie rod end from the steering knuckle by striking the knuckle to dislodge the tie rod end. Do not remove the factory Jam Nut from the inner tie rod. Discard the outer tie rod as a new Fabtech tie rod end will be installed later. **SEE FIGURE 1**

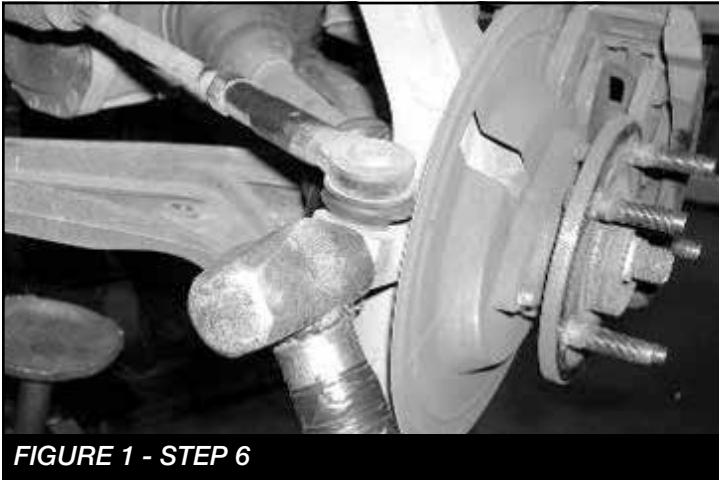

FIGURE 1 - STEP 6

7. Remove the brake caliper and place it next to the frame. Do not overstretch the brake hose when doing so. **DO NOT LET THE BRAKE CALIPER HANG FROM THE BRAKE HOSE.** Retain the hardware for reinstallation. Remove the brake rotor and save. Unplug the ABS wire at the plug behind the inner fender well and remove the ABS line clamp where it is attached to the steering knuckle.
8. Remove the axle nut from the center of the hub and save.
9. Remove the upper and lower ball joint nuts and save. Using a large hammer, strike the steering knuckle to dislodge the ball joints from the steering knuckle. **USE CARE NOT TO DAMAGE THE THREADS ON THE BALL JOINTS.** Remove the steering knuckle from the truck.

10. Remove the bolts attaching the hub bearing to the steering knuckle and save. Remove hub assembly along with the ABS sensor wire and dust shield from the steering knuckle as one and save. **NOTE:** Do not disconnect the ABS sensor from the hub at anytime. Note position of the hub in the steering knuckle for later re-installation. Discard the steering knuckle.
11. Remove the three upper shock assembly bolts from the truck and save. Remove the lower shock bolt and save. Remove the shock assembly from the truck and save. The factory shock assembly will be reused if you are installing the 6" Basic System. If you are installing the 6" Performance System, you can discard the factory shock assembly and hardware.
12. Remove the factory lower control arm bolts / alignment cams and save. Remove the lower control arm and save.
13. Remove the C.V. half shaft from the differential. This can be done by using a rubber mallet and striking the backside of the inner C.V. joint housing. Save the half shaft. **NOTE:** The differential may leak some gear oil.
14. Repeat steps 6-13 on the passenger side of the truck.
15. Remove the factory rear crossmember from the truck and discard the crossmember and hardware.
16. **IF INSTALLING ON VEHICLES EQUIPPED WITH GAS ENGINE PROCEED TO STEP 19.**
17. **FOR DIESEL ENGINES ONLY:** Removal of steering rack is required to access bolt on top of differential. Unplug connectors on steering rack. Remove bolt that secures the steering shaft to the rack **SEE FIGURE 2**

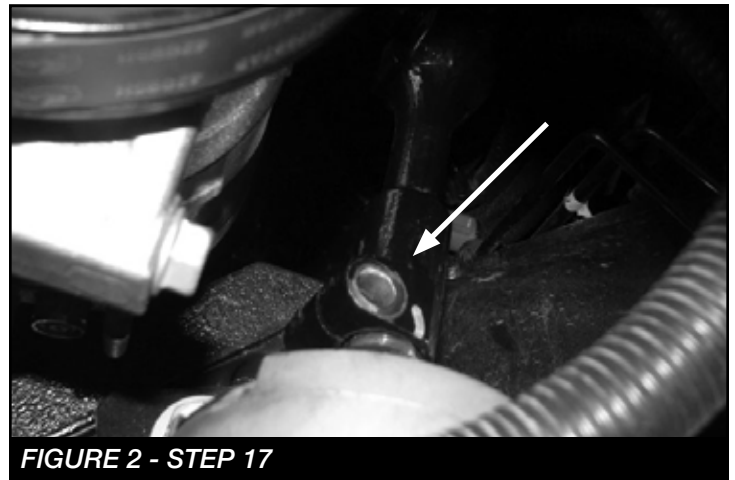
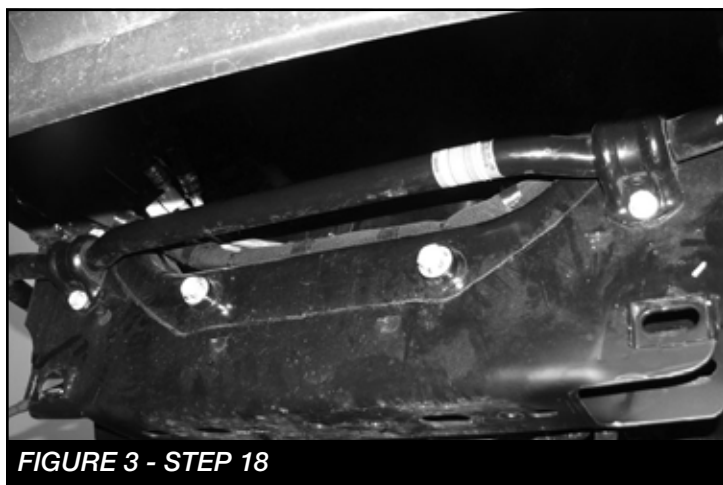

FIGURE 2 - STEP 17

18. Supporting the steering rack, Remove the (2) bolts. **SEE FIGURE 3.** Gently remove the rack and set aside.



19. Support the differential with a floor jack or transmission jack, disconnect solenoid and remove the differential from the truck. Save the hardware some will be re-used.
20. Locate the driver side rear lower control arm mount where the factory rear crossmember was previously removed. As shown in the picture below, using a die grinder cut a 1" section from the side of the frame and 1/2" from the bottom of the frame. **SEE FIGURES 4-5.**

DUE TO VARIANCES IN EACH TRUCK, ADDITIONAL CUTTING / GRINDING MAY BE REQUIRED FOR PROPER FITMENT OF THE CROSSMEMBERS AND DIFFERENTIAL. USE THESE MEASUREMENTS AS A STARTING POINT AND CLEARANCE THE FRAME POCKETS AS NEEDED FOR PROPER FITMENT OF THE CROSSMEMBERS & DIFFERENTIAL.



21. Locate the Passenger side rear lower control arm mount where the factory rear crossmember was previously removed. As shown in the picture below cut a 1" section from the side of the frame and 1/2" from the bottom of the frame. **SEE FIGURES 6-7**



22. Locate the factory front lower control arm pockets. Grind $\frac{1}{4}$ " section from both pockets as shown in the photo.

SEE FIGURES 8-9



FIGURE 8 - STEP 22

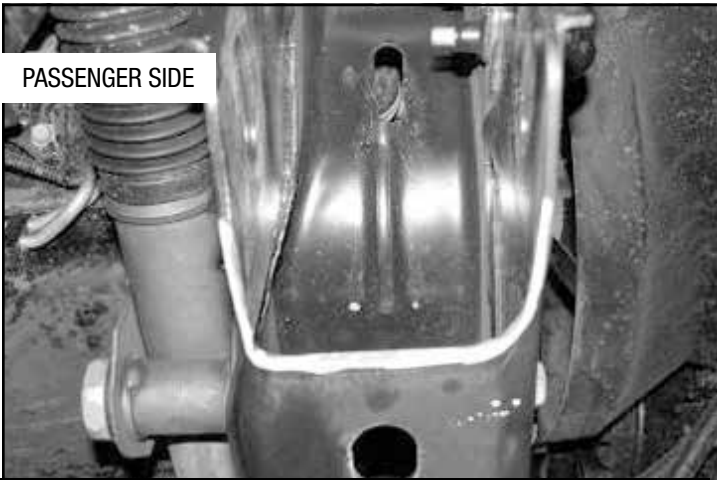

FIGURE 9 - STEP 22

23. Locate FT44020 and FT44026 passenger side differential mounts. Using the supplied $\frac{1}{2}$ " x $2\frac{3}{4}$ " hardware attach the brackets to the differential using **(FOR GAS ENGINES)** FT44205 (1.000X.563X.665-larger spacer). The spacers will provide space between the FT44020 bracket and the differential. **SEE FIGURE 10**. Leave loose at this time. **FOR DIESEL MODELS:** Locate FT50232 (1.000X.531X.450 smaller spacer) and remount the harmonic dampener to the the differential. **SEE FIGURE 11.**

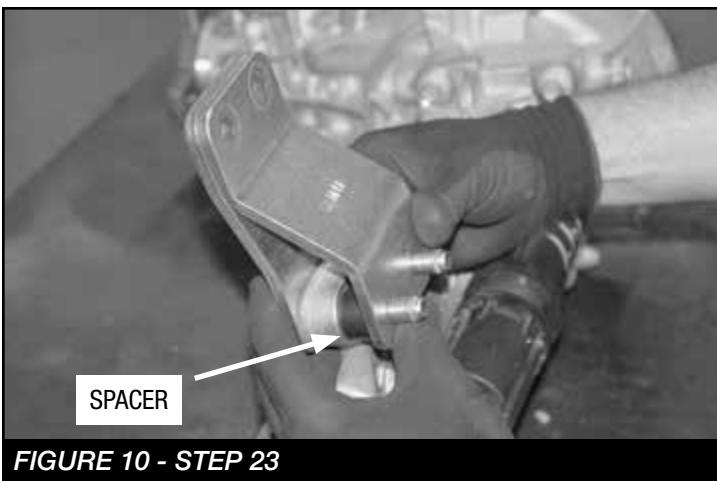

FIGURE 10 - STEP 23

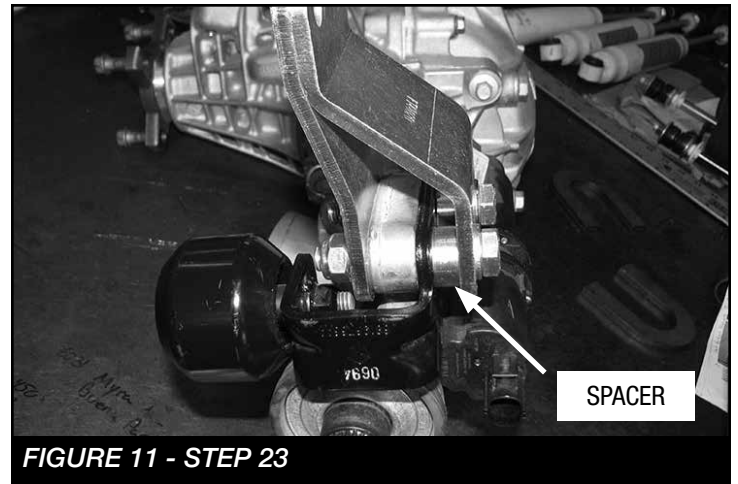

FIGURE 11 - STEP 23

24. Locate FT44021, FT44207 Driver front diff mounts and 6 $\frac{1}{2}$ " SAE Washers. Using the supplied $\frac{1}{2}$ "X $2\frac{1}{2}$ " hardware attach the brackets to the differential as shown in the diagram. Leave loose at this time.

SEE FIGURES 12-14



FIGURE 12 - STEP 24



FIGURE 13 - STEP 24

25. Locate FT44204 Driver rear diff mount. Using the M12x35mm bolts, lock washers and flat washers attach the bracket to the original diff mount. Leave loose at this time. **SEE FIGURES 13-14**

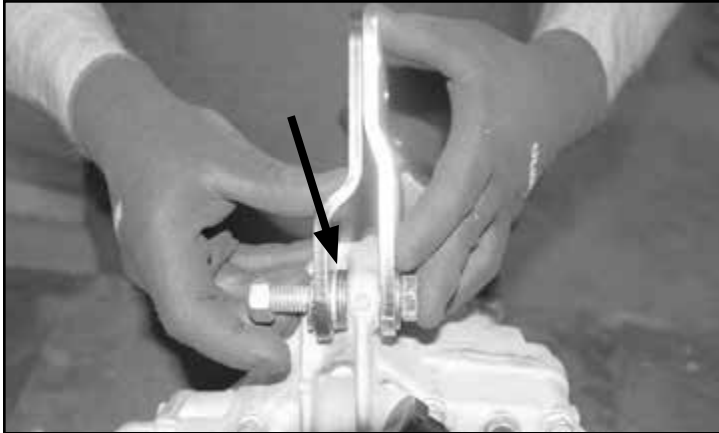

FIGURE 14 - STEP 24

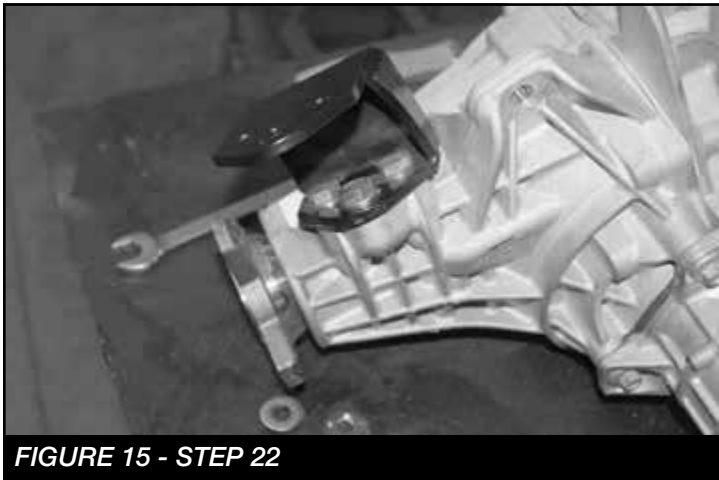

FIGURE 15 - STEP 22

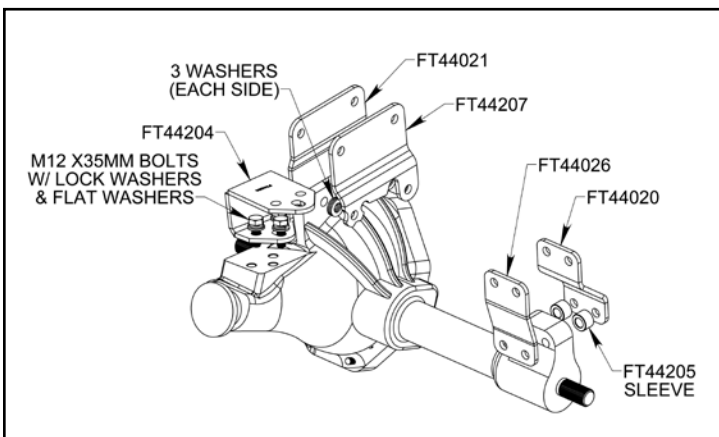

FIGURE 16 - STEP 23 - 25

26. Install the differential back into the truck attaching the new Fabtech drop brackets to the factory frame mounts. Use the factory hardware on the passenger side bracket and use the supplied $\frac{1}{2}$ -13 x $1 \frac{3}{4}$ bolt, nuts, and washer on the driver rear brackets. **DO NOT** mount the Driver front diff mount at this time. **LEAVE ALL HARDWARE LOOSE AT THIS TIME.**

27. Locate FT44358BK front crossmember and install it into the front lower control arm pockets using the supplied $\frac{5}{8}$ " x $5 \frac{1}{2}$ " bolts, nuts, and washers. Leave loose at this time. **SEE FIGURE 17**



FIGURE 17 - STEP 27

28. Locate FT44089BK rear crossmember and install it into the frame pockets using the $\frac{5}{8}$ " x $5 \frac{1}{2}$ " bolts, nuts, and washers. Leave loose at this time. **SEE FIGURE 18**



FIGURE 18 - STEP 28

29. Install the factory hardware on the driver side front diff bracket. Torque all differential hardware to 100 ft lbs. **SEE FIGURE 19**



FIGURE 19 - STEP 29

30. **DIESEL MODELS ONLY:** Once the differential is in and torqued, proceed with re-installing the steering rack. Use steps 17,18 in reverse order. Torque the steering shaft bolt to 36 ft-lbs. and the (2) crossmember bolts to 235 ft-lbs.

31. Working from the driver side of the truck, install the factory lower control arm to the Fabtech crossmembers using the original alignment cam bolts. Leave loose at this time. **SEE FIGURE 20**



FIGURE 20 - STEP 31

32. Install the C.V. half shaft back onto the differential by pushing the half shaft onto the splines until the snap ring locks. **SEE FIGURE 21**

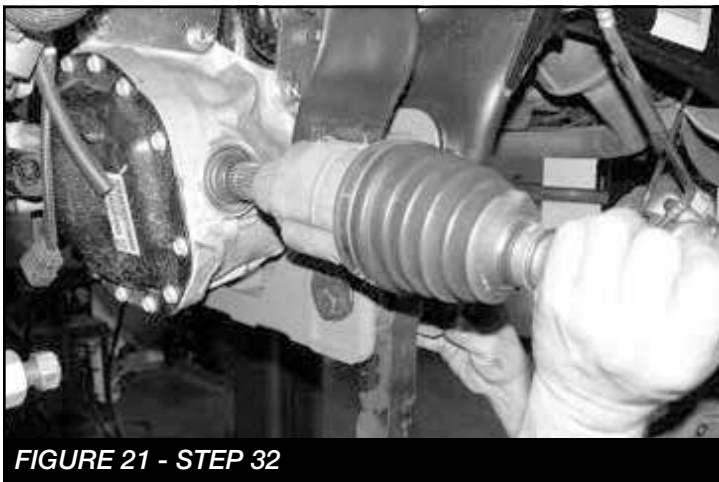

FIGURE 21 - STEP 32

**FOLLOW STEPS 33-34 FOR BASIC KIT ONLY.
IF INSTALLING THE PERFORMANCE SYSTEM
WITH DIRT LOGIC 2.5 COILOVERS, INSTALL THE
COILOVER SO IT IS OFFSET AWAY FROM THE
AXLE.**

33. Locate the previously removed shock assembly and attach FT44209BK spacer to the top of the shock assembly using the stock hardware. Use a small amount of the supplied thread locking compound on the supplied shock to spacer hardware. Torque to 35 ft-lbs. You will need to mount the spacer so that it aligns properly with the coilover. **SEE FIGURES 22-23**



FIGURE 22 - STEP 33



FIGURE 23 - STEP 33

34. Install the complete shock assembly into the truck attaching the three upper bolts first using the supplied 7/16" C-lock and flat washers, leave loose. Torque upper hardware to 83 ft. lbs. **SEE FIGURE 24**



FIGURE 24 - STEP 34

35. Locate FT44115D (driver) Steering Knuckle. Attach the previously removed hub bearing and dust shield to the knuckle in the same position as when removed using the original hardware and a small amount of the supplied thread locking compound on each bolt. Torque to 95 ft. lbs. Use the supplied adel clamp, and 1/4" x 3/4" hardware and a small amount of thread locking compound and attach the A.B.S. line to the front of the knuckle. Torque to 10 ft-lbs. **SEE FIGURES 25-26**



36. Attach the steering knuckle to the lower ball joint first, and then slide the C.V. shaft end through the hub bearing, followed by the upper ball joint to the steering knuckle. Torque the lower ball joint nut to 82 ft-lbs and the upper ball joint nut to 50 ft lbs. Using the original C.V. axle nut, attach the C.V. axle to the hub assembly. Torque to 100 ft lbs. Then attach the lower shock mount to the original mount on the lower control arm using the original hardware and torque to 90 ft.-lbs. **SEE FIGURES 27-28**

37. Repeat steps 35-40 on Passenger side of truck.



38. Locate FT44019BK skid plate and attach to the front crossmember using the supplied 1/2" X 2 3/4" bolt, nut, and washer, and to the rear crossmember using the supplied 1/2" x 1 1/4" bolt and flat and split washer. Torque to 90 ft-lbs. **SEE FIGURE 29**



39. Torque the Fabtech crossmember bolts to 100 ft lbs and control arm pivot bolts / Alignment Cams to 110 ft. lbs. Set the cams in the middle of their adjustment.

40. Locate the factory brake line in the coilover tower. Carefully cut the tower to remove the brake line. Remove the bracket from the frame saving the hardware. Carefully pull the brake line down from the frame approximately 4" (use care to not damage the hard line). Locate FT44071 Driver Brake Line Drop Mount Bracket and attach in original brake line mounting position. Locate the supplied $\frac{1}{4}$ " x $\frac{3}{4}$ " hardware and attach the factory brake line bracket to the new drop bracket. Torque to 10 ft-lbs.

SEE FIGURE 30

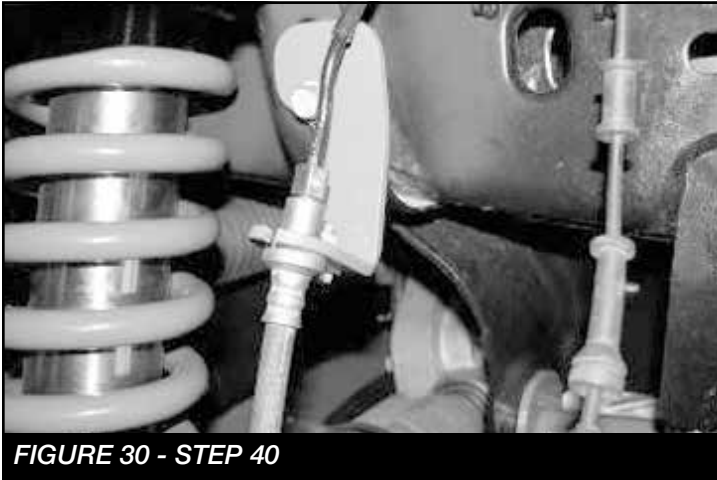

41. Working from the drivers side, install the factory brake rotor and caliper. Use a small amount of the supplied thread lock compound on the caliper bolts and torque to 145 ft. lbs.

42. Locate the ABS plug on the inside of the fender well liner and remove the plastic clip holding it to the liner (use care not to damage connector). Route the ABS wire up from the knuckle parallel with brake lines and attach to the brake lines with the supplied zip ties.

SEE FIGURES 31-32

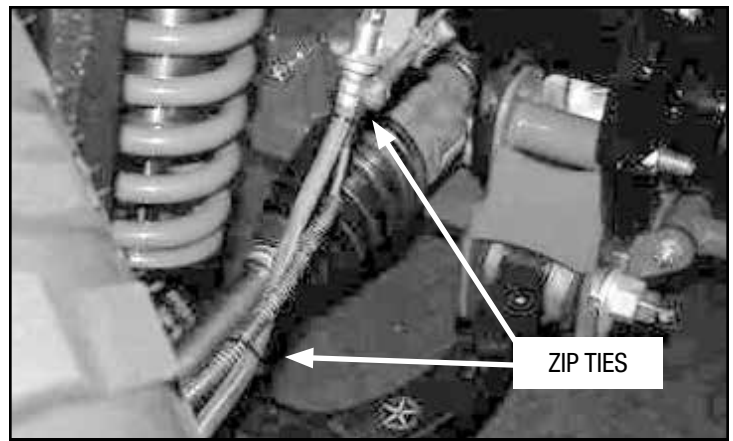
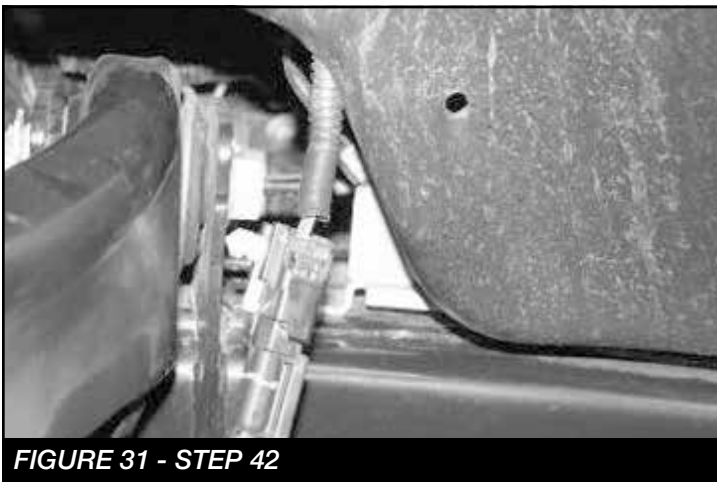

FIGURE 32 - STEP 42

43. Locate the inner tie rod ends. Mark a $\frac{3}{4}$ " in from the end of the tie rod. Using a die grinder with a cutoff wheel, cut a $\frac{3}{4}$ " off of the end of the inner tie rod. Next using a die grinder with a sanding disc, clean up the threads on the inner tie rod so that the new Fabtech outer tie rod threads on without any binding of the threads.

SEE FIGURES 33-34

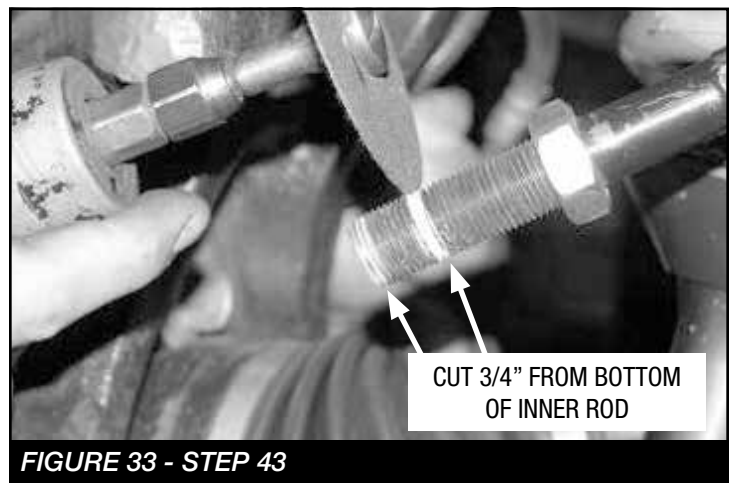

FIGURE 33 - STEP 43



44. Locate FT44288 tie rod end and thread it onto the factory inner tie rod end. Note: This is just a starting point, the toe adjustment will need to be set during the final alignment. Tighten the jam nut up to the tie rod end. Attach the tie rod end to the steering knuckle using the supplied 14mm nut. Torque to 85 ft lbs.
45. Repeat steps 44-48 on the passenger side of the truck.
46. Locate FT44029 (09-11) or FT44203 (2012) front drive shaft spacer. Using the supplied thread-locking compound, 12mm bolts, and washer, attach the spacer and drive shaft to the front differential. Torque to 135 ft. lbs. **SEE FIGURE 35**



47. Locate FT44073 Lower Sway Bar Mounts and supplied 3/8" C-lock nuts and flat washers. Attach the mounts to the lower A-Arm in the factory sway bar location. Leave loose at this time.
48. Loosen the four bolts holding the Sway Bar to the factory crossmember, Remove the two bolts from the driver side and discard. Locate and insert the FT44133 Sway Bar Spacer with the supplied M12-1.75 x 70mm bolts and washers. Repeat on the passenger side leaving hardware loose. **SEE FIGURE 36**



49. Locate both FT44075 Billet Sway Bar End Links and both of the supplied FTS98003 heim joints along with the supplied jam nuts. Thread the jam nuts all the way onto the heim joints, then thread the heim joints into the large end of the end links. Leave the jam nuts loose at this time. Locate the supplied 1/2" button head bolts and the FT90084 sway bar bushings along with the cup washers. Attach the bushing end of the sway bar end links to the factory sway bar, leave loose at this time. Attach the other end of the link using the supplied FT43 mis-alignments and supplied 1/2" x 2 3/4" hardware to the new mount on the lower arm. Torque upper and lower hardware to 60 ft. lbs. At times this may be easier to attach when the truck is completed and on the ground. **SEE FIGURES 37-38**

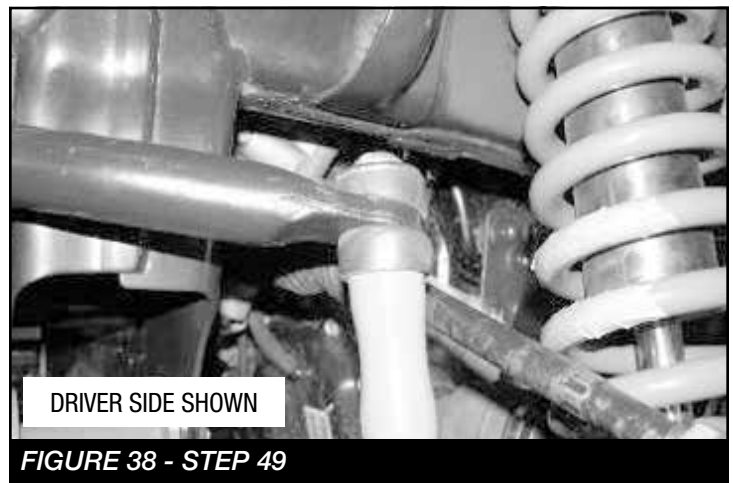

50. Install front tires and wheels. Torque lug nuts to wheel manufacturer's specifications

Double Check That All Nuts And Bolts Are Now Tight Before Proceeding To The Rear.

REAR SUSPENSION

51. Disconnect the sway bar end links from the frame and sway bar; discard the end links and the hardware.
52. Remove the upper pivot bolt that attaches the track bar to the frame and save.
53. Remove the fender wells.
54. Using a floor jack, raise the differential just enough to slightly compress the rear shocks. Remove the bolts securing the top of the shocks to the frame.
55. Loosen and remove brake lines from frame, make sure they are clear and have enough slack when removing the rear coils.
56. Lower the floor jack to release the coil springs. Remove the coil springs from the vehicle and save the rubber coil insulators.
57. Remove the lower shock bolts and discard the shocks.
58. Remove the factory lower links arms. Discard the links and save the hardware.
59. Locate 44163BK Rear Upper Link, FT44164BK Rear Lower Links, FT1038 Bushing and FT77 Sleeves. Using an arbor press, press the bushings and sleeves (use supplied bushing lube) into each end of the links and install the supplied zerks fittings.
60. Install the new Lower Link Arms into the factory rear axle mounts with the factory hardware. Then attach the arm to the frame mounts also with the factory hardware. Leave loose at this time. **SEE FIGURE 39**



FIGURE 39 - STEP 60

61. Locate FT44188BK (driv) & FT44189BK (pass) Rear Bumpstop Brackets and the supplied 7/16"x1 1/2" hardware. Place the bump stop extension mounts onto the existing pads on the top of the differential. Mark and drill the front and rear 7/16" hole in the bumpstop and attach using the 7/16" hardware. Using the 7/16" bolts, washers and C-lock nuts and FT44045 nut tab, secure the mount to the differential. There should be a flat washer on each side of the bolt. Torque to 83 ft lbs.

SEE FIGURES 40-42



FIGURE 40 - STEP 61

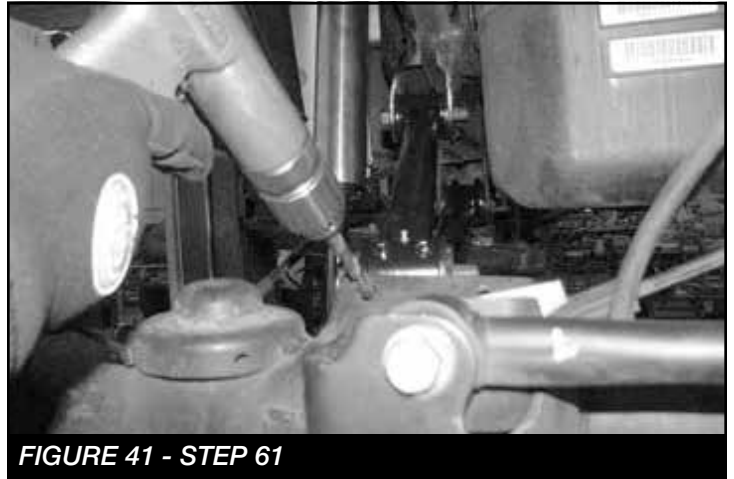

FIGURE 41 - STEP 61

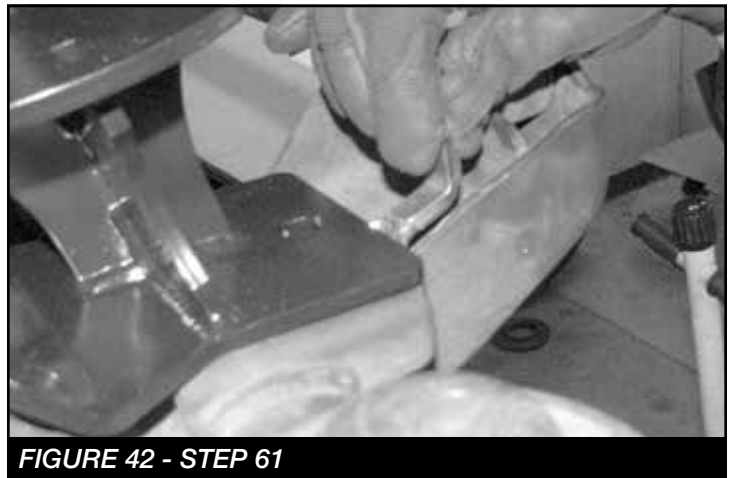

FIGURE 42 - STEP 61

62. Attach the E brake cable to the tab on the link arm using 5/16" hardware. **SEE FIGURE 43**



63. Remove the factory upper links arms and discard the links. Save the hardware. Install the new Upper Link Arms into the factory rear axle mounts with the factory hardware. Then attach the arm to the frame mounts also with the factory hardware. Torque to 160 ft.-lbs. **SEE FIGURE 44**



64. Locate FT44187BK Track Bar Bracket, FT44166BK Track Bar Bracket Support, Track bar sleeve FT189 and the 3/4", 1/2" and 14mm hardware. Cutting of the factory bracket is required. Measure and cut 1/4" off the factory bracket. **SEE FIGURE** Insert the sleeve into the factory track bar bracket. Position the track bar bracket onto the factory mount on the frame and install the 14mm bolt and hardware. **SEE FIGURES 45-47**

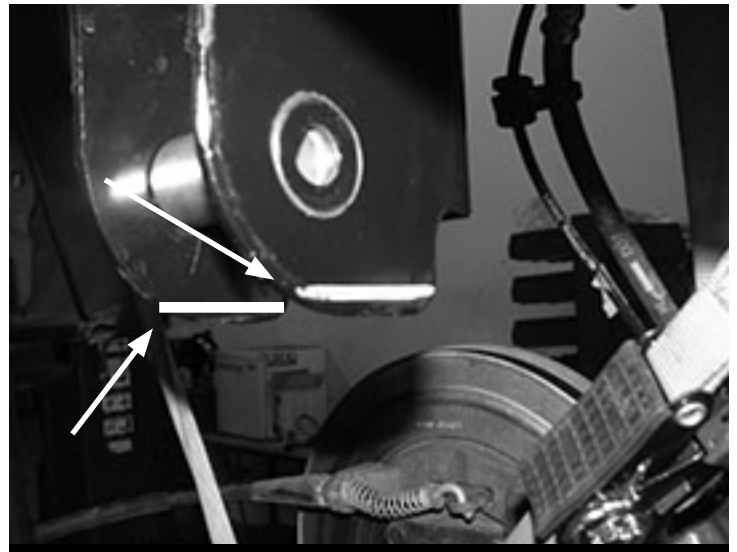

65. Mount the track bar support tube to the rear crossmember using the supplied 3/4" x 3" bolt, nut, and washers. Leave loose at this time. **SEE FIGURES 52**



FIGURE 52 - STEP 65

66. Use the open 1/2" holes in the Fabtech bracket as guide to drill out the two holes for the locking bolts in the factory bracket. Insert the two 1/2" x 1" bolts into the new holes with nuts tabs FT5036. Torque to 90 ft-lbs. Torque the 14mm bolt in the stock pivot hole to a 160 ft-lbs. Torque the frame side of the trac bar support tube to 317 ft-lbs. **SEE FIGURE 48**



FIGURE 48 - STEP 66

67. Insert the track bar into the Fabtech track bar bracket and install the factory hardware. Torque the factory bolt 160 ft-lbs. **SEE FIGURE 49**



FIGURE 49 - STEP 67

68. Install the Fabtech coil springs FT50302BK using the factory coil isolator. **SEE FIGURE 50**

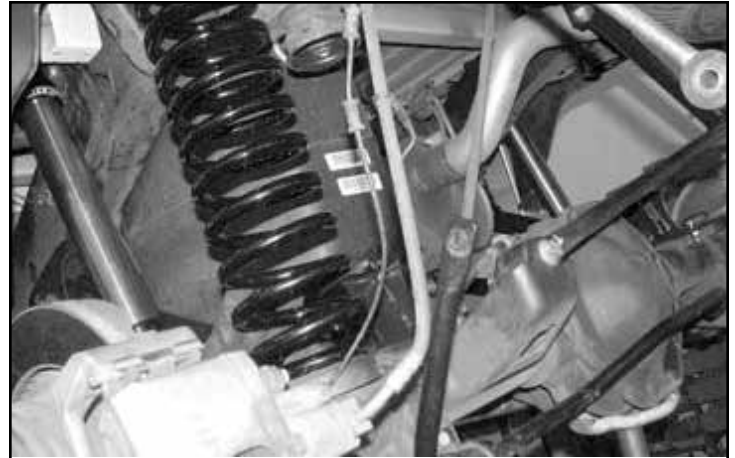

FIGURE 50 - STEP 68

69. Locate the new sway bar links FT1599-2-4 and insert 2 bushing halves and a sleeve into each end (use the supplied lube). Install one end of the link into the frame mount and insert the M12 x 70mm bolt through the sleeve. Attach the sway bar to other end of the link with M12 x 70mm bolt, nut and washer. Torque to 65 ft-lbs. **SEE FIGURE 51**

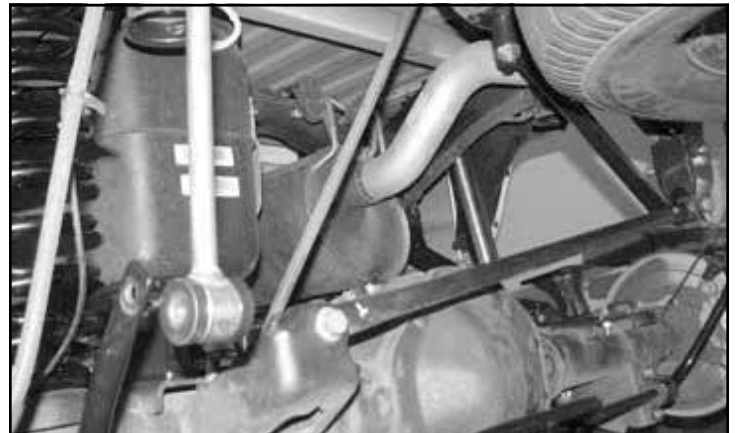

FIGURE 51 - STEP 69

70. Install the rear shocks FTS7333 or FTS6333 using the stock hardware.

71. Re-install the rear fender wells.

72. Install tires and wheels and torque lug nuts to wheel manufacturer's specifications. Turn front tires left to right and check for appropriate tire clearance. **Note - Some oversized tires may require trimming of the front bumper & valance.**

73. Check front end alignment and set to factory specifications. Readjust headlights.

74. Recheck all bolts for proper torque.

75. Recheck brake hoses, ABS wires and suspension parts for proper tire clearance while turning tires fully left to

right.

76. Check the fluid in the front and rear differential and fill if needed with factory specification differential oil. **Note - some differentials may expel fluid after filling and driving. This can be normal in resetting the fluid level with the new position of the differential/s.**
77. Install Driver Warning Decal. Complete product registration card and mail to Fabtech in order to receive future safety and technical bulletins on this suspension

Vehicles that will receive oversized tires should check ball joints and all steering components every 2500-5000 miles for wear and replace as required.

RE-TORQUE ALL NUTS, BOLTS AND LUGS AFTER 50 MILES AND THEREAFTER UNTIL FASTENERS RETAIN TORQUE SETTING.

For technical assistance call: 909-597-7800

- Product Warranty and Warnings -

Fabtech provides a Limited Lifetime Warranty to the original retail purchaser who owns the vehicle, on which the product was originally installed, for defects in workmanship and materials.

The Limited Lifetime Warranty excludes the following Fabtech items; bushings, bump stops, ball joints, tie rod ends, limiting straps, cross shafts, heim joints and driveshafts. These parts are subject to wear and are not considered defective when worn. They are warranted for 60 days from the date of purchase for defects in workmanship.

Dirt Logic and Performance Coilover take apart shocks are considered a serviceable shock with a one year warranty on leakage only. Service seal kits are available separately for future maintenance. All other shocks are covered under our Limited Lifetime Warranty.

Fabtech does not warrant any product for finish, alterations, modifications and/or installation contrary to Fabtech's instructions. Alterations to the finish of the parts including but not limited to painting, powder coating, plating and/or welding will void all warranties. Some finish damage may occur to parts during shipping, which is considered normal and is not covered under warranty.

Fabtech products are not designed nor intended to be installed on vehicles used in race applications or for racing purposes or for similar activities. (A "RACE" is defined as any contest between two or more vehicles, or any contest of one or more vehicle against the clock, whether or not such contest is for a prize). This warranty does not include coverage for police or taxi vehicles, race vehicles, or vehicles used for government or commercial purposes. Also excluded from this warranty are sales outside of the United States of America.

Installation of most suspension products will raise the center of gravity of the vehicle and will cause the vehicle to handle differently than stock. It may increase the vehicle's susceptibility to a rollover, on road and off road, at all speeds. Extreme care should be taken to operate the vehicle safely at all times to prevent rollover or loss of control resulting in serious injury or death. Fabtech front end Desert Guards may impair the deployment or operation of vehicles equipped with supplemental restraining systems/air bag systems and should not be installed if the vehicle is equipped as so.

Fabtech makes every effort to ensure suspension product compatibility with all vehicles listed on the website, but due to unknown auto manufacturer's production changes and/or inconsistencies by the auto manufacturer, Fabtech cannot be responsible for 100% compatibility, including the fitment of tire and wheel sizes listed. The Tire and Wheel sizes listed in Fabtech's website are only a guideline for street driving with noted fender trimming. Fabtech is not responsible for damages to the vehicle's body or tires. Fabtech is not responsible for premature wear of factory components due to the installation of oversized tires and wheels.

Fabtech's obligation under this warranty is limited to the repair or replacement, at Fabtech option, of the defective product only. All costs of removal, installation or re-installation, freight charges, incidental or consequential damages are expressly excluded from this warranty. Fabtech is not responsible for damages and/or warranty of other vehicle parts related or non related to the installed Fabtech product. This warranty is expressly in lieu of all other warranties expressed or implied. This warranty shall not apply to any product that has been subject to accident, negligence, alteration, abuse or misuse as determined by Fabtech.

Fabtech suspension components must be installed as a complete system including shocks as shown on our website. All warranties will become void if Fabtech parts are combined and/or substituted with other aftermarket suspension products. Combination and/or substitution of other aftermarket suspension parts may cause premature wear and/or product failure resulting in an accident causing injury or death. Fabtech does not warrant products not manufactured by Fabtech.

Depending on the condition of the factory suspension components retained after the installation of a Fabtech suspension not all vehicles may have the same ride stance front to rear as described in the website. The blue color of suspension components shown in all Fabtech photographs are for display purposes only. Majority of all Fabtech components will be black specifically where noted with part numbers ending in BK.

Installation of Fabtech product may void the vehicles factory warranty; it is the consumer's responsibility to check with their local vehicle's dealer for warranty disposition before the installation of the product. Some state laws may prohibit modification of suspension to a vehicle in whole or in part. It is the responsibility of the installer and consumer to consult local laws prior to the installation of any Fabtech suspension product to comply with such written laws.

It is the responsibility of the distributor and/or the retailer to review all warranties and warnings of Fabtech products with the consumer prior to purchase.

Fabtech reserves the right to super cede, discontinue, change the design, finish, part number and/or application of parts when deemed necessary without written notice. Fabtech is not responsible for misprints or typographical errors within the website or price sheet. For the most recent Product Warranty and Warnings visit our website www.fabtechmotorsports.com