



INSTALLATION INSTRUCTIONS

2017 FORD F250/350 4WD 4" BUDGET SYSTEM

FTS22212

Fabtech Motorsports | 4331 Eucalyptus Ave. Chino, CA 91710

Tech Line: 909-597-7800 | **Fax:** 909-597-7185 | **Web:** www.fabtechmotorsports.com

- PARTS LIST -

FTS22212		4" BUDGET SYSTEM
1	FT30463BK	TRAC BAR DROP 4"
2	FT30651	RADIUS ARM DROP
2	FT30653	4" BUMP STOP EXT
1	FT30678	HARDWARE KIT
1	FT30680	HARDWARE SUBASSEMBLY
2	FT30542BK	COIL SPACER 4"
1	FT30664	ABS EXTENSION BRACKET
1	FT30583BK	STEERING STABILIZER BRACKET
4	FT728U	UBOLT RD 5/8-18 X 16.50 X 3.50
2	FTBK43	4" BLOCK W/BUMPSTOP

FT30680		HARDWARE SUBASSEMBLY
1	FT22212i	INSTRUCTIONS
1	FT30663	COIL WASHER
1	FT30677	WASHER W/BEND
2	FT30659	BRAKE LINE TAB
2	FT50290	BUMP STOP NUT TAB
1	FT30688	ABS TAB
1	FTAS12	STICKER FT BLUE 10X4 DIE CUT
1	FTAS16	DRIVER WARNING DECAL
1	FTREGCARD	REGISTRATION CARD

K2213		4" BUDGET SYSTEM W/PERFORMANCE SHOCKS
1	FTS22212	4" BUDGET SYSTEM
2	FTS7236	PERFORMANCE SHOCK (FRONT)
2	FTS7266	PERFORMANCE SHOCK (REAR)

K2213M		4" BUDGET SYSTEM W/ STEALTH SHOCKS
1	FTS22212	4" BUDGET SYSTEM
2	FTS6236	STEALTH MONOTUBE (FRONT)
2	FTS6063	STEALTH MONOTUBE (REAR)

K2213DL		4" BUDGET SYSTEM W/ DLSS SHOCKS
1	FTS22212	4" BUDGET SYSTEM
2	FTS810962	2.25 DIRT LOGIC SS N/R (FRONT)
2	FTS810052	2.25 DIRT LOGIC SS N/R (REAR)

FT30678 - HARDWARE KIT		LOCATION
2	3/8-16 X 1" HEX BOLT	BRAKE LINE
4	3/8" SAE WASHER	
2	3/8-16 NYLOCK NUT	
2	1/4 SAE WASHER	
1	1/4-20 GR C CROWNLOCK NUT	
1	1/4-20 X 3/4 HEX BOLT G5 ZINC	
2	1/2-13 X 1-1/4 HEX BOLT	BUMP STOP
2	1/2-13 X 1-1/2 HEX BOLT	
6	1/2 SAE WASHER	
2	1/2-13 C-LOCK NUT	
8	3/4-10 X 1-1/4" HEX BOLT	RADIUS ARM DROP
20	3/4 SAE WASHER	
8	5/8-18 NYLOCK NUT	UBOLTS
8	5/8" WASHER	
2	3/4 X 6" HEX BOLT	COIL SPACER
4	3/4 SAE WASHER	
10	3/4-10 C-LOCK NUT	
1	M12-1.75 X 70MM HEX BOLT	STEERING STABILIZER
2	M12 WASHER	
1	M12-1.75 C-LOCK	
2	3/8-16 X 1-1/4" HEX BOLT	ABS BRACKET
4	3/8 SAE WASHER	
2	3/8-16 NYLOCK NUT	
1	7/16-14 X 1" HEX BOLT	
2	7/16 SAE WASHER	
1	7/16-14 C-LOCK NUT	
1	THREAD LOCKING COMPOUND 1 MIL	
1	HOSE CLAMP	



- TOOL LIST -

Required Tools (Not Included)

- | | |
|--|-------------------|
| -Basic Hand Tools | -Basic Hand Tools |
| -Assorted Metric and S.A.E sockets, and Allen wrenches | -Floor Jack |
| -Torque Wrench | -Jack Stands |
| -Die Grinder w/ Cutoff Wheel or Sawzall | -Drill |
| - 1-1/4" Hole Saw | |

- PRE-INSTALLATION NOTES -

For technical assistance call: **909-597-7800** or e-mail: **info@fabtechmotorsports.com**

READ THIS BEFORE YOU BEGIN INSTALLATION -

Check all parts to the parts list above before beginning installation. If any parts are missing contact Fabtech at 909-597-7800 and a replacement part will be sent to you immediately.

Read all instructions thoroughly from start to finish before beginning the installation. If these instructions are not properly followed severe frame, driveline and / or suspension damage may occur.

Check your local city and state laws prior to the installation of this system for legality. Do not install if not legal in your area.

Prior to the installation of this suspension system perform a front end alignment and record. Do not install this system if the vehicle alignment is not within factory specifications. Check for frame and suspension damage prior to installation.

The installation of this suspension system should be performed by two professional mechanics.

This suspension must be installed with Fabtech shock absorbers.

Use the provided thread locking compound on all hardware.

WARNING- Installation of this system will alter the center of gravity of the vehicle and may increase roll over as compared to stock.

Vehicles that receive oversized tires should check ball joints, uniballs, tie rods ends, pitman arm and idler arm every 2500-5000 miles for wear and replace as needed.

Verify differential fluid is at manufactures recommended level prior to kit installation. Installation of the kit will reposition the differential and the fill plug hole may be in a different position. (For example, if the manufacture recommends 3 quarts of fluid, make sure the diff has 3 quarts of fluid). Check your specific manual for correct amount of fluid.

Recommend Tires and Wheels:

- Use 35/12.50R18 tire w/ 18x9.5 wheels w/ 4-3/4" BS w/ required fenderwell trimming
- Use 35/12.50R20 tire w/ 20x9 wheels w/ 5" BS w/ required fenderwell trimming

FOOTNOTES -

- INSTRUCTIONS -

FRONT SUSPENSION

1. Disconnect the negative terminal on the battery. Jack up the front end of the truck and support the frame rails with jack stands. **NEVER WORK UNDER AN UNSUPPORTED VEHICLE!** Remove the front tires.
2. Disconnect the sway bar from the sway bar end links. Save hardware. **SEE FIGURE 1**



FIGURE 1 - STEP 2

3. Disconnect the brake line from the frame and axle on both driver and passenger sides. Save hardware. **SEE FIGURES 2-3**

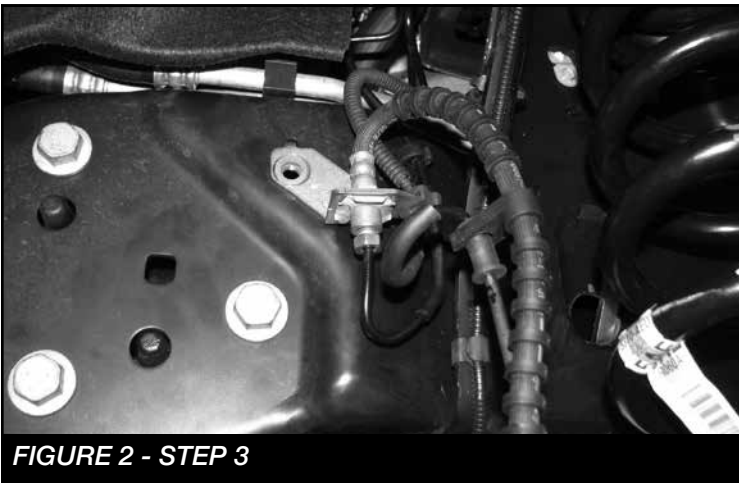

FIGURE 2 - STEP 3



FIGURE 3 - STEP 3

4. Remove the front shocks and discard, save hardware.
5. Lower the front axle allowing the coil springs to come free of tension and remove the coil springs. **EXERCISE EXTREME CAUTION WHEN WORKING WITH COIL SPRINGS UNDER LOAD!**
6. Disconnect the factory steering stabilizer from the frame mount. Remove the steering stabilizer frame bracket. Discard the frame bracket. Leave the steering stabilizer connected to the drag link. Save all hardware.
7. Disconnect the trac bar from the frame bracket. Remove the trac bar bracket from the frame, save the original hardware and discard the factory trac bar bracket.
8. Locate FT30463BK (Track Bar Bracket). Attach to the frame using the original hardware in the same position. Torque bolts to 120 ft-lbs. **DO NOT ATTACH THE TRAC BAR TO THE FRAME BRACKET AT THIS TIME. SEE FIGURE 4-5**

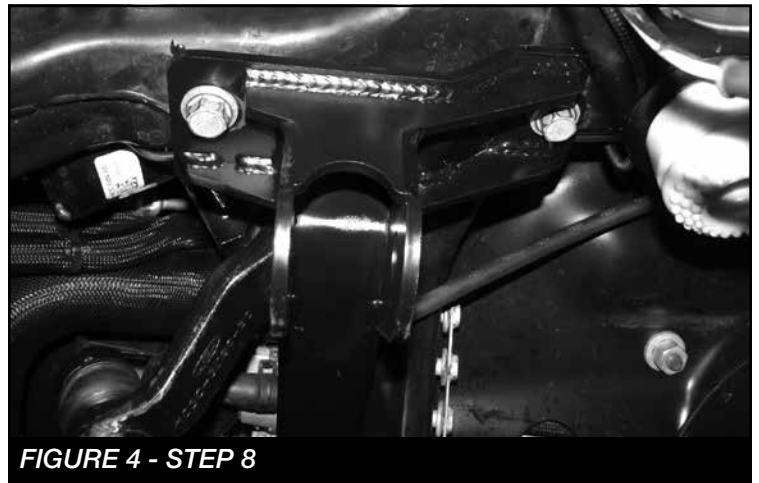

FIGURE 4 - STEP 8



FIGURE 5 - STEP 8

9. Working from both sides of the truck, locate and remove the factory front bump stops and save. Pull on the bump stop itself to free from the cup. Remove the factory mounting cup from the frame and discard the hardware. Drill out the center hole on the factory cup to 1/2". **SEE FIGURES 6-7**

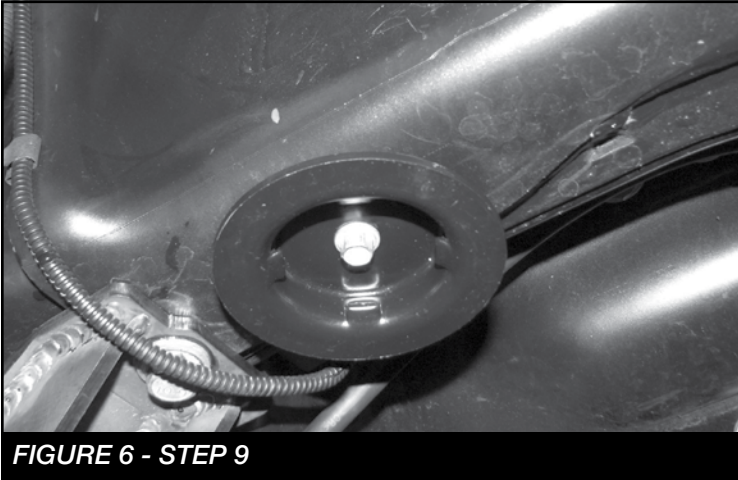

FIGURE 6 - STEP 9



FIGURE 7 - STEP 9

10. Install FT30653 (Bump Stop Extension) onto the factory cup using the supplied 1/2" x 1-1/4" hardware and set aside. Torque to 127 ft-lbs. **SEE FIGURE 8**

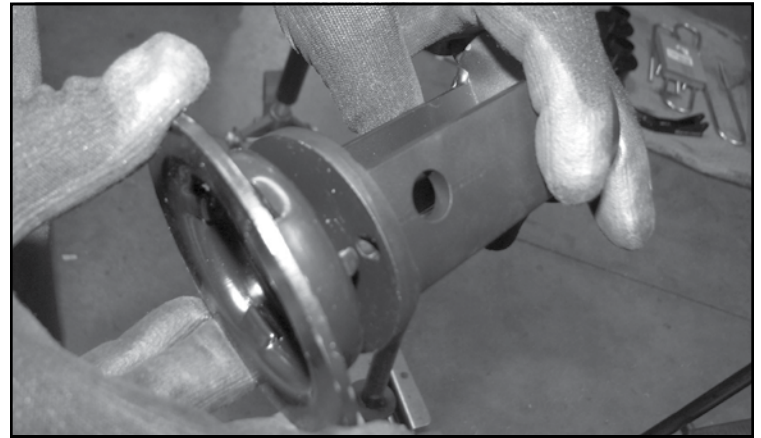

FIGURE 8 - STEP 10

11. Locate the factory bump stop mounting hole. Measure 3" straight up from the bottom of the frame. Mark and drill a 1-1/4" hole using a hole saw into the frame. **SEE FIGURES 9-10**

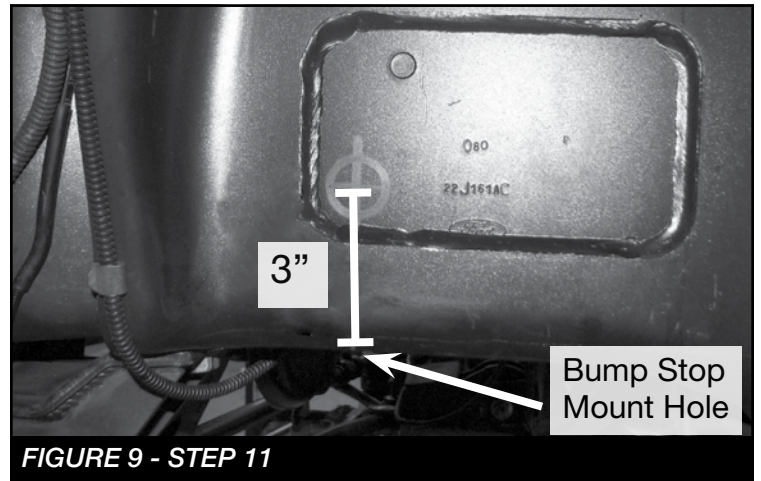
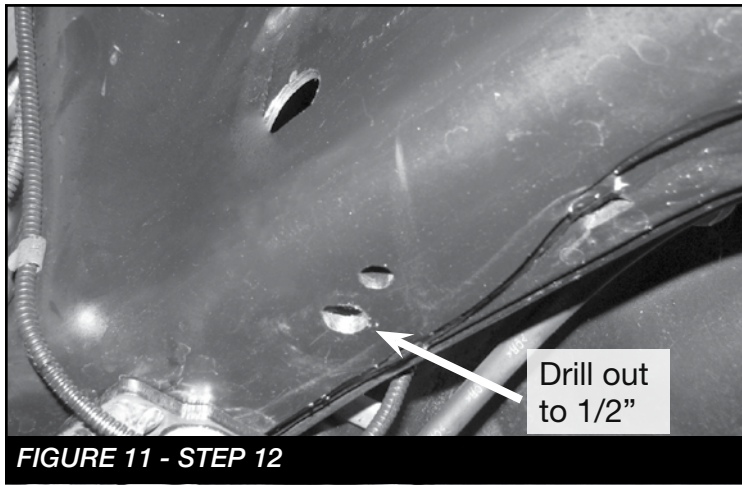

FIGURE 9 - STEP 11

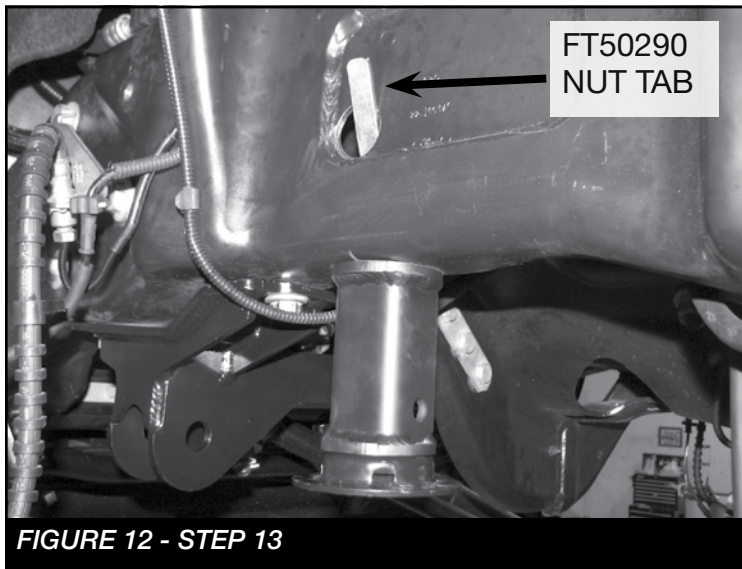

FIGURE 10 - STEP 11

12. Drill out the factory bump stop mount hole to 1/2". **SEE FIGURE 11**



13. Using FT50290 (Nut Tab) and 1/2" X 1-1/2" bolt and washer. Mount the new bump stop extension to the frame. Route the Nut tab through the 1-1/4" hole that was made in Step 11. Torque to 127 ft-lbs. **SEE FIGURE 12**



REPEAT BUMP STOP INSTALLATION ON PASSENGER SIDE

14. Remove the driver side inner fender liner. Locate the ABS module mounted to the factory spring perch. Remove and save the bolt attaching the bracket to the front of the spring perch. Using a 13mm wrench remove the (2) nuts that attach the L bracket together. Then using the same 13mm wrench remove the nuts attaching the same bracket to the back side of the factory spring perch. Discard the factory bracket and save the hardware. **SEE FIGURE 13**

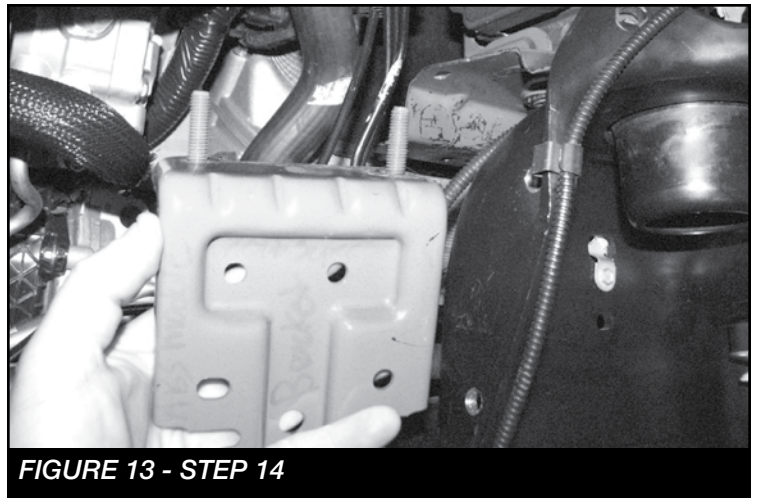

15. With the front axle still supported by the floor jack, remove both of the front factory radius arms from the factory frame mounts. Remove the upper bolt at the axle and allow the radius arm to hang. Save the factory hardware.
16. Install FT30651 (radius arm drop brackets). Place the brackets into the factory radius arm pockets. Attach the bracket to the factory bracket using the supplied 3/4" x 1-1/4" bolts, nuts and washers through the original holes in the frame. Torque bolts to 317 ft-lbs. **SEE FIGURE 14**

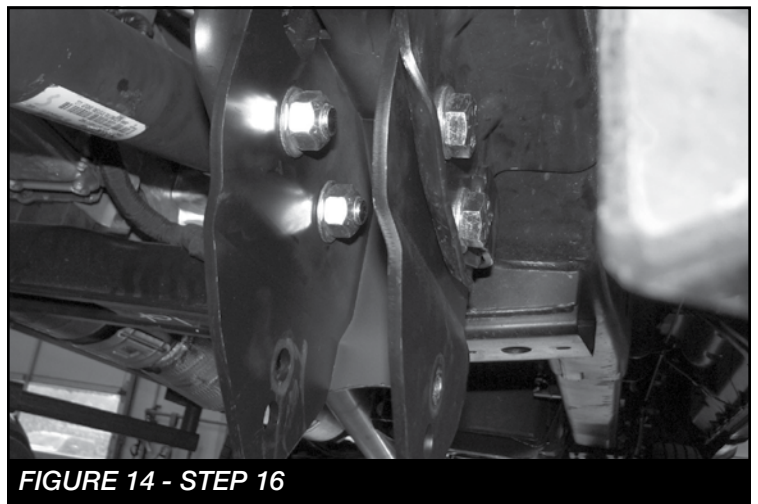

17. Reinstall the radius arms into the new drop down bracket using the factory hardware. Attach to the axle first then to the new drop bracket using the upper most hole. Torque to 200 ft-lbs. **SEE FIGURE 15**

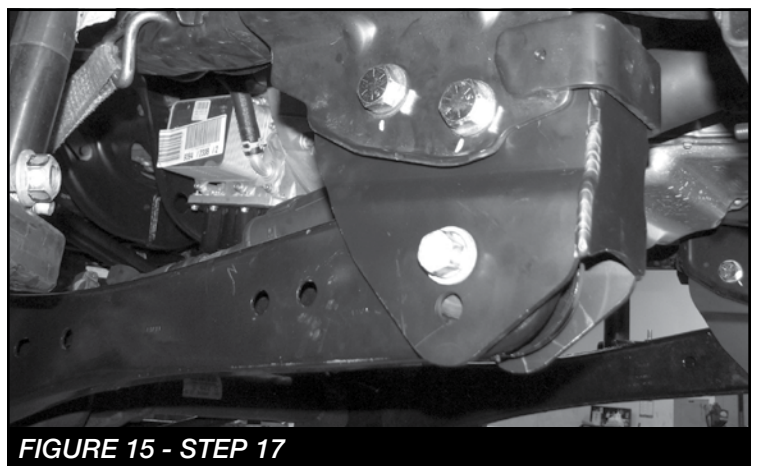

18. Locate the FT30542BK (Coil spacer), 3/4"-10 x 6" bolt and the FT30663 washer. Install all the components into the factory coil bucket in the order shown below using the original factory upper coil isolator. Torque the 3/4" bolt to 129 ft-lbs. **SEE FIGURE 16**

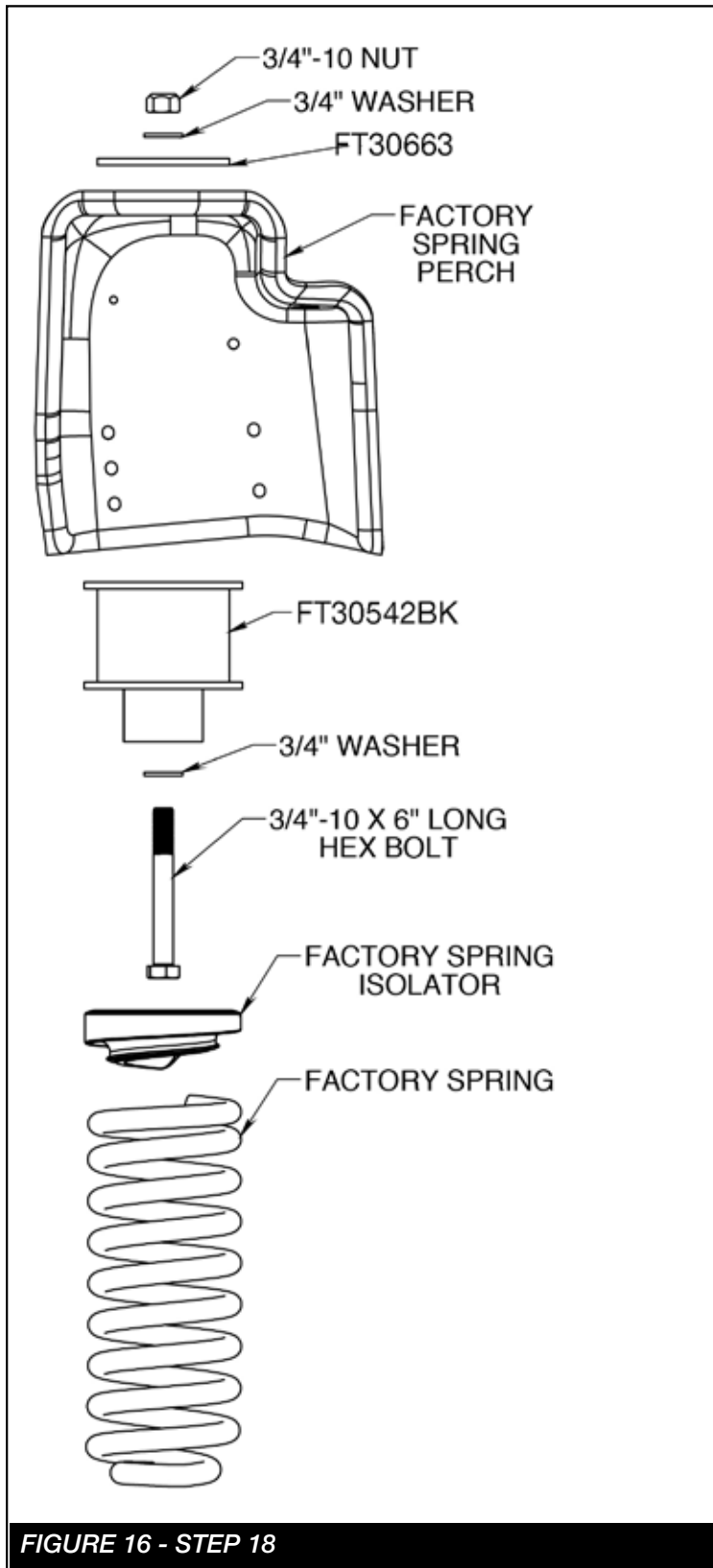

19. Locate and install FT30664 (ABS Bracket) in the same location as the factory bracket previously removed using the factory nuts on the spring perch and the supplied 3/8" X 1-1/4" hardware. Torque to 52 ft-lbs. **SEE FIGURE 17**

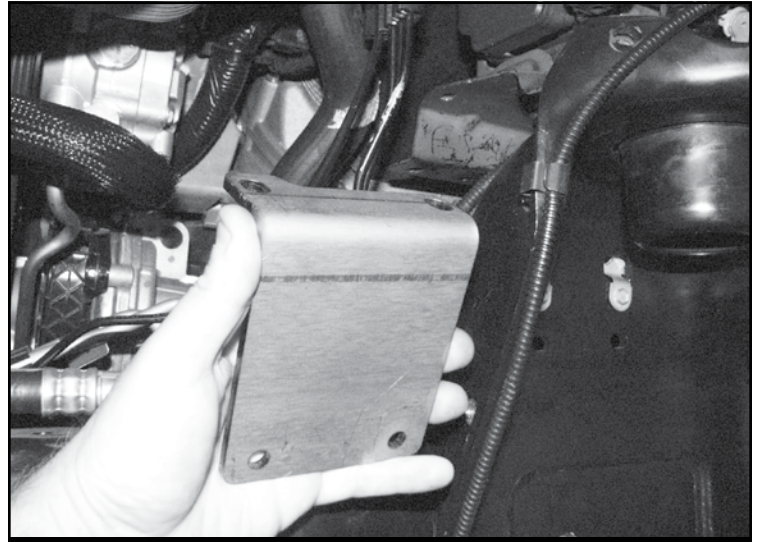

20. Install FT30688 (ABS Tab) using the factory and 5/16" hardware. Torque to 29 ft-lbs. **SEE FIGURE 18**



- Reinstall Driver fender liner-

21. Locate the passenger side factory spring perch. The factory ABS line tab will need to be removed. Remove the ABS line from the tab and cut using a cut off wheel. **SEE FIGURE 19-20**



FIGURE 19 - STEP 21



FIGURE 20 - STEP 21

22. Repeat STEP 18 using FT30677 (washer) on the top of the factory spring perch. **SEE FIGURE 21**



FIGURE 21 - STEP 22

23. Install the new front shocks FTS7236, FTS6236 or FTS810962 with the supplied bushing kits. Use the factory hardware at the lower mount.
24. Position the factory trac bar into the new trac bar bracket. **Note:** You may need to raise the axle up or down to align the hole. Using the original bolt, insert it from the front side of the bracket towards the back. Torque the trac bar bolt to 400 ft-lbs.

25. **(DRIVER SIDE)** Install FT30659 (Brake line bracket) to the factory brake line tab using the supplied 3/8" hardware. Next, install the bracket to the frame using the factory hardware. Torque hardware to 52 ft-lbs. **SEE FIGURE 22**



FIGURE 22 - STEP 25

26. **(PASSENGER SIDE)** Install FT30659 (Brake line bracket) to the factory brake line tab using the supplied 3/8" hardware (Use lower hole). Next, using the supplied rubber clamp and 1/4" hardware, attach the ABS line to the upper hole on the FT30659 bracket. Re attach to the frame using the factory hardware. Torque 3/8" & factory hardware to 52 ft-lbs. Torque 1/4" hardware to 14 ft-lbs. **SEE FIGURE 23**

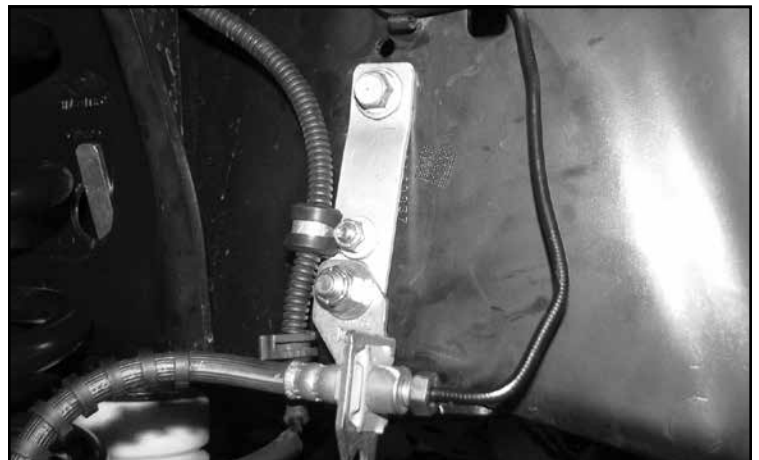

FIGURE 23 - STEP 26

27. Install FT30583BK (steering stabilizer drop bracket) in the factory location using the factory hardware. Torque to 127 ft-lbs. Reattach the factory stabilizer to the frame bracket using the factory hardware. **SEE FIGURE 24**



28. Reconnect the front sway bar to the end links using the factory hardware and torque to 59 ft-lbs.
29. Install the lower brake line bracket to the lower spring perch using the factory hardware. Torque to 29 ft-lbs.
30. Install the front tires and wheels. Torque lug nuts to wheel manufacturer's specifications.

REAR SUSPENSION

31. Locate and install the 4" rear lift blocks FTBK43. The factory block will need to be removed. The short end of the blocks should face to the front of the vehicle. Using the supplied u-bolts, nuts and washers align axle, lift blocks and springs and torque to U-Bolts to 254 ft-lbs.
32. Install the new rear shocks FTS7266, FTS6063 or DL FTS810052 using the factory hardware, torque to 90 ft-lbs.
33. Install tires and wheels and torque lug nuts to wheel manufacturer's specifications. Turn front tires left to right and check for appropriate tire clearance. **Note - Some oversized tires may require trimming of the front bumper & valance.**
34. Check front end alignment and set to factory specifications. Readjust headlights.
35. Recheck all bolts for proper torque.
36. Recheck brake hoses, ABS wires and suspension parts for proper tire clearance while turning tires fully left to right.
37. Check the fluid in the front and rear differential and fill if needed with factory specification differential oil. **Note - some differentials may expel fluid after filling and driving. This can be normal in resetting the fluid level with the new position of the differential/s.**
38. Install Driver Warning Decal. Complete product registration card and mail to Fabtech in order to receive future safety and technical bulletins on this suspension.

Vehicles that will receive oversized tires should check ball joints, uniballs and all steering components every 2500-5000 miles for wear and replace as required.

RETORQUE ALL NUTS, BOLTS AND LUGS AFTER 50 MILES AND PERIODICALLY THEREAFTER.

For technical assistance call: **909-597-7800**

- Product Warranty and Warnings -

Fabtech provides a Limited Lifetime Warranty to the original retail purchaser who owns the vehicle, on which the product was originally installed, for defects in workmanship and materials.

The Limited Lifetime Warranty excludes the following Fabtech items; bushings, bump stops, ball joints, tie rod ends, limiting straps, cross shafts, heim joints and driveshafts. These parts are subject to wear and are not considered defective when worn. They are warranted for 60 days from the date of purchase for defects in workmanship.

Dirt Logic and Performance Coilover take apart shocks are considered a serviceable shock with a one year warranty on leakage only. Service seal kits are available separately for future maintenance. All other shocks are covered under our Limited Lifetime Warranty.

Fabtech does not warrant any product for finish, alterations, modifications and/or installation contrary to Fabtech's instructions. Alterations to the finish of the parts including but not limited to painting, powder coating, plating and/or welding will void all warranties. Some finish damage may occur to parts during shipping, which is considered normal and is not covered under warranty.

Fabtech products are not designed nor intended to be installed on vehicles used in race applications or for racing purposes or for similar activities. (A "RACE" is defined as any contest between two or more vehicles, or any contest of one or more vehicle against the clock, whether or not such contest is for a prize). This warranty does not include coverage for police or taxi vehicles, race vehicles, or vehicles used for government or commercial purposes. Also excluded from this warranty are sales outside of the United States of America.

Installation of most suspension products will raise the center of gravity of the vehicle and will cause the vehicle to handle differently than stock. It may increase the vehicle's susceptibility to a rollover, on road and off road, at all speeds. Extreme care should be taken to operate the vehicle safely at all times to prevent rollover or loss of control resulting in serious injury or death. Fabtech front end Desert Guards may impair the deployment or operation of vehicles equipped with supplemental restraining systems/air bag systems and should not be installed if the vehicle is equipped as so.

Fabtech makes every effort to ensure suspension product compatibility with all vehicles listed on the website, but due to unknown auto manufacturer's production changes and/or inconsistencies by the auto manufacturer, Fabtech cannot be responsible for 100% compatibility, including the fitment of tire and wheel sizes listed. The Tire and Wheel sizes listed in Fabtech's website are only a guideline for street driving with noted fender trimming. Fabtech is not responsible for damages to the vehicle's body or tires. Fabtech is not responsible for premature wear of factory components due to the installation of oversized tires and wheels.

Fabtech's obligation under this warranty is limited to the repair or replacement, at Fabtech option, of the defective product only. All costs of removal, installation or re-installation, freight charges, incidental or consequential damages are expressly excluded from this warranty. Fabtech is not responsible for damages and/or warranty of other vehicle parts related or non related to the installed Fabtech product. This warranty is expressly in lieu of all other warranties expressed or implied. This warranty shall not apply to any product that has been subject to accident, negligence, alteration, abuse or misuse as determined by Fabtech.

Fabtech suspension components must be installed as a complete system including shocks as shown on our website. All warranties will become void if Fabtech parts are combined and/or substituted with other aftermarket suspension products. Combination and/or substitution of other aftermarket suspension parts may cause premature wear and/or product failure resulting in an accident causing injury or death. Fabtech does not warrant products not manufactured by Fabtech.

Depending on the condition of the factory suspension components retained after the installation of a Fabtech suspension not all vehicles may have the same ride stance front to rear as described in the website. The blue color of suspension components shown in all Fabtech photographs are for display purposes only. Majority of all Fabtech components will be black specifically where noted with part numbers ending in BK.

Installation of Fabtech product may void the vehicles factory warranty; it is the consumer's responsibility to check with their local vehicle's dealer for warranty disposition before the installation of the product. Some state laws may prohibit modification of suspension to a vehicle in whole or in part. It is the responsibility of the installer and consumer to consult local laws prior to the installation of any Fabtech suspension product to comply with such written laws.

It is the responsibility of the distributor and/or the retailer to review all warranties and warnings of Fabtech products with the consumer prior to purchase.

Fabtech reserves the right to super cede, discontinue, change the design, finish, part number and/or application of parts when deemed necessary without written notice. Fabtech is not responsible for misprints or typographical errors within the website or price sheet. For the most recent Product Warranty and Warnings visit our website www.fabtechmotorsports.com