



**2008-10 FORD F250 / F350 2WD  
6" BASIC KIT  
FTS22122BK**



**4331 EUCALYPTUS AVE. ~ CHINO, CA 91710  
909-597-7800 FAX 909-597-7185**



**2008-10 FORD F250 / F350**

**6" BASIC KIT**

<b>FTS22122BK 6" Basic Kit</b>		
<b>QTY.</b>	<b>PART #</b>	<b>DESCRIPTION</b>
2	FT30467BK	Radius Arm Drop brackets
1	FT410-109BK	Driver I-Beam Bracket
1	FT410-103BK	Pass. I-Beam Bracket
1	FT30217	Hardware Kit
4	43141751081	7/16"-14X1 3/4" Hex Bolt
7	43141501081	7/16"-14X1 1/2" Hex Bolt
2	FT22122i	Instruction Sheet

<b>FT30217 HARDWARE KIT</b>	
<b>QTY.</b>	<b>DESCRIPTION</b>
2	1/4"-20 X 1" Hex Head Bolt
2	1/4"-20 nylock nut
4	1/4" SAE flat washer
6	7/16"-14 x 1 1/2" hex head bolt
6	7/16"-14 nylock nut
12	7/16" SAE flat washer
1	1/2"-13 x 1" hex head bolt
7	1/2"-13 x 1 1/4" hex head bolt
4	1/2"-13 x 1 1/2" hex head bolt
3	1/2"-13 x 3 1/2" hex head bolt
2	1/2"-13 x 4" hex head bolt
17	1/2"-13 nylock nut
36	1/2" SAE flat washer
4	1/2" USS flat washer
8	3/4"-10 x 1 1/2" bolts
8	3/4"-10 C-lock nut
16	3/4" flat washer
1	1/8" x 2" cotter pin
1	Thread lock

<b>FTS22121BK 6" COIL KIT V10 SAND DIESEL</b>		
<b>QTY.</b>	<b>PART #</b>	<b>DESCRIPTION</b>
2	FT137BK	Coil 6" Lift
2	FT410-108	Coil Spacer
1	FT3400-112P	Sway Bar Drop
1	FT3400-112D	Sway Bar Drop
2	FT410-107BK	Bump Stop Drop
1	FT30205	Steering Stabilizer Drop
1	FT30122	Pitman Arm
1	FT30206	Pitman Arm Spacer
2	FT594	Alignment Cam
2	FT30303	Brake Line Bracket
2	FT30409	8" Brake Line
2	FT30410	Brake Line Union
1	FTAS12	Fabtech Warning
1	FTAS16	Driver Warning

<b>FTS22128BK 6" COIL KIT V8 GAS 5.4</b>		
<b>QTY.</b>	<b>PART #</b>	<b>DESCRIPTION</b>
2	FT136BK	Coil 6" Lift
2	FT410-108	Coil Spacer
1	FT3400-112P	Sway Bar Drop
1	FT3400-112D	Sway Bar Drop
2	FT410-107BK	Bump Stop Drop
1	FT30205	Steering Stabilizer Drop
1	FT30122	Pitman Arm
1	FT30206	Pitman Arm Drop
1	FT30258	Sector Shaft Arm Nut
2	FT594	Alignment Cam
2	FT30303	Brake Line Bracket
2	FT30409	8" Brake Hard Line
2	FT30410	Brake Line Union



**2008 - 2010 FORD F250 / F350  
6" BASIC KIT**

**TOOL LIST:**

- FLOOR JACKS
- JACK STANDS
- DRILL WITH ASSORTED BITS
- ASSORTED METRIC & SAE WRENCHES & SOCKETS
- TORQUE WRENCH
- AIR HAMMER WITH CHISEL & PUNCH BITS
- DIE GRINDER WITH CUT -OFF WHEEL

**READ BELOW BEFORE INSTALLING THIS KIT**

**CHECK ALL PARTS INCLUDED IN THIS KIT TO THE PARTS LIST ABOVE BEFORE BEGINNING INSTALLATION OF THE KIT. IF ANY PIECES ARE MISSING, CONTACT FABTECH AT 909-597-7800.**

**THIS SUSPENSION SYSTEM MUST BE INSTALLED WITH FABTECH SHOCK ASBORBERS**

**VEHICLES THAT WILL RECEIVE OVERSIZED TIRES SHOULD CHECK BALL JOINTS, TIE RODS ENDS AND IDLER ARM EVERY 2500-5000 MILES FOR WEAR AND REPLACE AS NEEDED**

**PRIOR TO THE INSTALLATION OF THIS SUSPENSION SYSTEM A FRONT END ALIGNMENT MUST BE PERFORMED AND RECORDED. DO NOT INSTALL THIS SYSTEM IF THE VEHICLE ALIGNMENT IS NOT WITHIN FACTORY SPECIFICATIONS. CHECK FOR FRAME AND SUSPENSION DAMAGE PRIOR TO INSTALLATION.**

**READ ALL INSTRUCTIONS THOROUGHLY FROM START TO FINISH BEFORE BEGINNING INSTALLATION.**

**FABTECH RECOMMENDS THAT YOU EXERCISE EXTREME CAUTION WHEN WORKING WITH COIL SPRINGS TO AVOID ANY POSSIBILITY OF INJURY.**

## INSTRUCTIONS:

1. Disconnect the negative terminal on the battery. Jack up the front end of the truck and support the frame at the front frame rails with jack stands. **NEVER WORK UNDER AN UNSUPPORTED VEHICLE.** Remove the front tires. Disconnect the negative terminal on the battery.
2. Working on both sides of the truck, disconnect the A.B.S. sensor at its connection point at the back of the wheel liner and from the plastic clamps along the brake line (do not remove from the spindle). Next remove the brake caliper and tie it up out of the way and save the hardware. **DO NOT ALLOW THE CALIPERS TO HANG FROM THE BRAKE LINES!** Remove the front shocks and the sway bar with the end links from the truck. Save the shock and the sway bar and hardware. Loosen the I-Beam pivot bolts, **DO NOT REMOVE THE BOLTS FROM THE I-BEAM BRACKET.** SEE PHOTO BELOW

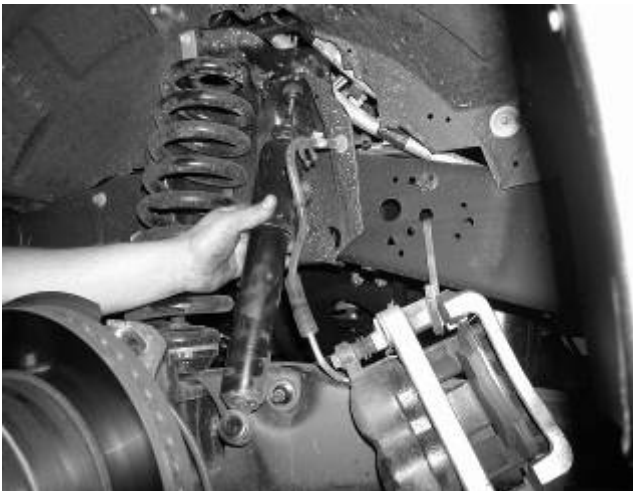

3. Working from the driver side of the truck, support the I-beam with a jack and remove the J clip at the top of the coil spring. **EXERCISE EXTREME CAUTION WHEN WORKING WITH COIL SPRINGS UNDER LOAD!** Lower the floor jack supporting the I-beam and remove the nut at the bottom of the coil spring. Discard the coil spring, and save all hardware.
4. Remove the nut and bolt at the end of the radius arm and the bolt securing the radius arm to the I Beam. Separate the radius arm from the I Beam and save all of the hardware and the radius arm.
5. Supporting the factory I-beam with a floor jack, remove the factory I-beam pivot bolt and save. Lower the floor jack removing the I beam from the truck.
6. Repeat steps three through five on the passenger side of the truck.

7. Working from both sides of the truck, locate and remove the factory front bump stops and save. These can be removed by pulling on the bump stop itself from the cup. Remove the factory mounting cup from the frame and save it and the hardware. SEE PHOTO BELOW



8. Locate the two rivets on the bottom of the coil bucket. Using a die grinder with a cutoff wheel, make an X cut on the face of the rivet. Next, using an air chisel, remove the rivets from the bucket and frame. Using a drill, drill the two holes out to 1/2".
9. Locate FT410-106 and FT410-107 front bump stop drop brackets and 1/2" x 1 1/2" bolt and hardware. Attach the bump stop brackets to the frame to the two holes that you previously removed the rivets from and torque the bolts to 50lbs. Now attach the bump stop cup to the new brackets using the factory hardware. Press the factory bump stop back into the cup. SEE PHOTO BELOW.



10. Separate the drag link from the pitman arm. Remove the factory pitman arm from the steering box using a large pitman arm puller or large two-jaw puller. Save

the hardware and discard the pitman arm. SEE PHOTO ON NEXT PAGE.



11. Locate FTS30122 new drop pitman arm. Attach to the steering box in the same indexed position as the factory pitman arm was when removed. **Install the provided FT30258 Sector Shaft Nut and torque to 350 ft. lbs. (Note: this is a one-time only use nut, once it is tightened on the sector shaft and removed, it must be discarded. SEE PHOTO BELOW.**



12. Remove the factory steering stabilizer from the frame bracket and save the hardware. Remove the bracket from the frame and discard and save the hardware.
13. Remove the factory I beam brackets from the frame. Discard the brackets and hardware.
14. Locate FT410-104 & FT410-103 I-beam drop brackets and place the brackets against the frame in the factory I-beam pivot location. Attach the new drop brackets to the frame using the included hardware. You will reuse most of the factory holes and have to drill some new ones. Locate the existing holes with the supplied bolts and mark the new holes that must be drilled with a center punch. Drill the holes with a pilot drill (1/8") and follow through with a 1/2" drill. **BE SURE THERE IS NOTHING BEHIND THE FRAME SECTIONS YOU ARE DRILLING**

**THROUGH, PLACE A PIECE OF PLATE STEEL ABOVE THE FRAME BELOW THE OIL PAN TO PREVENT DRILLING INTO THE PAN.** Tighten all the fasteners securing the brackets to the frame and torque to 75lbs. SEE PHOTOS BELOW.



**Driver Side I-beam Bracket**  
*Passenger I-Beam connection point*



**Passenger Side I-beam Bracket**  
*Driver I-Beam connection point*

15. Attach the factory I-beams to the new drop brackets in the bottom holes re-using the factory bolts, leave loose at this time.
16. Working from the driver side of the truck, locate FT30467 radius arm drop bracket. Place the bracket into the factory radius arm pockets on the frame. Attach the bracket to the factory pocket using the supplied 3/4" x 1 1/2" bolts, nuts, and washers through the original holes in the frame. Torque bolts to 100 ft. lbs.
17. Once the new brackets are bolted in the stock pockets, locate the 7/16" hole in the bottom of the new bracket. Using a drill with a 7/16" drill bit, drill through the bracket into the stock pocket. Attach using the supplied 7/16" x 1 1/2" bolts, nuts, and hardware. SEE PHOTOS ON NEXT PAGE.

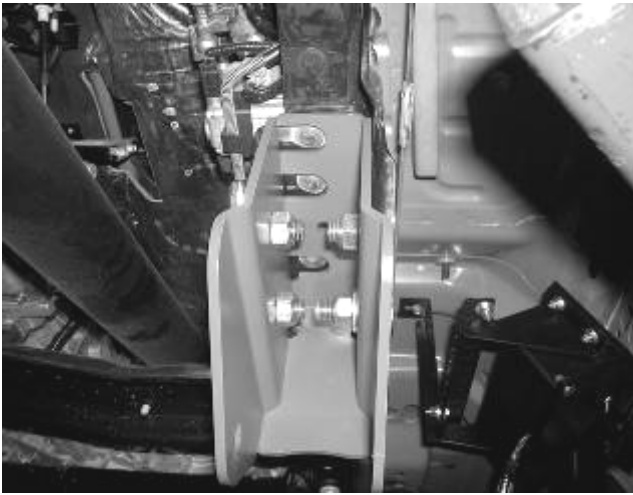
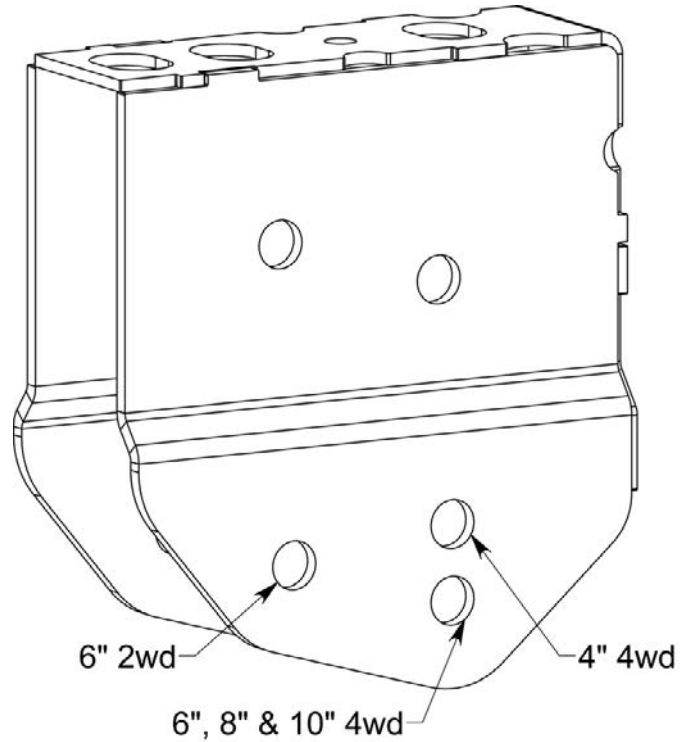

Photo Shown w/Radius Arm Installed

18. Locate both driver and passenger side factory radius arms and radius arm bolts. Attach both the driver and passenger radius arms to the I- Beams using the original hardware, just insert the bolt at this time with no nut. Attach the other end of the radius arms to the frame mounts using the original hardware. When mounting the radius arm to the new drop bracket you will use forward hole. Leave loose at this time. SEE DRAWING BELOW.



19. Locate the FT410-108 Coil Spacers. Place the spacer on the bolt that connects the I-beam and radius arm that was previously installed. Then place the factory nut on the bolt and torque to 150 ft. lbs. SEE PHOTOS BELOW.



Picture Shown w/Optional Radius Arm

20. Locate the lift coil springs and factory lower coil spring perch. Place the perch on top of the coil spacer along with the factory nylon lower coil seat. Seat the coil on the perch first, then into the coil bucket on the frame. Using the original nut and coil retainer attach the coil spring to the I Beam. Using the original "J" clip and original hardware attach the top of coil to the coil bucket. **NOTE-when installing the "J" clip, it will only grab the coil spring and not the bucket like it was factory.** SEE PHOTOS BELOW AND ON NEXT PAGE.

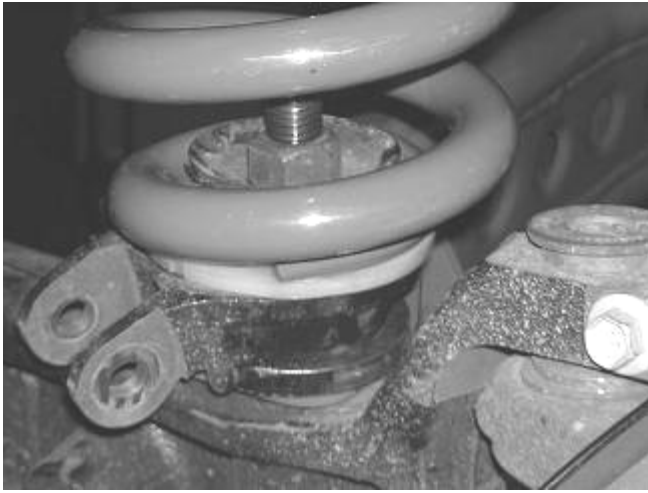

21. Using a floor jack, raise the front I-Beam enough to compress the front coils approx. 1". Locate the FTS7236 front shocks ( not included in kit ). The factory upper shock bushings must be removed from the coil bucket prior to installing the shocks. Install the top of the shocks using the supplied bushings and hardware and attach the lower mount with the original hardware. Tighten the top shock nuts until the bushings start to bulge and torque the lower bolts to 35 ft lbs. Torque the Radius Arm bolts to 200 lbs and the I-Beam pivot bolts to 150 lbs.
22. Locate the factory brake line mount on the front side of the frame. Remove the bracket from the frame and save the hardware. Locate FT30276 Front Brake Line Drop Bracket and attach to the frame using the original hardware in the factory brake line hole (with the offset of the bracket to the front of the truck). Locate the supplied 5/16" thread forming bolt. Use a drill with a 17/64<sup>th</sup> drill bit and drill the new hole from the drop bracket into the frame. Install the 5/16" thread-forming bolt into the new hole. Locate FT30409 Hard Brake Line Extension and separate the factory hose from the hard line. Install the supplied FT30410 union and hard line to the factory hard line. Connect the factory hose to the new hard line. Using the supplied 5/16" hardware, attach the factory brake line to the new drop bracket. You will need to carefully bend the hard line down to meet the new brake line bracket. **USE CARE NOT TO DAMAGE**

**THE HARD LINE.** SEE PHOTOS IN NEXT COLUMN.

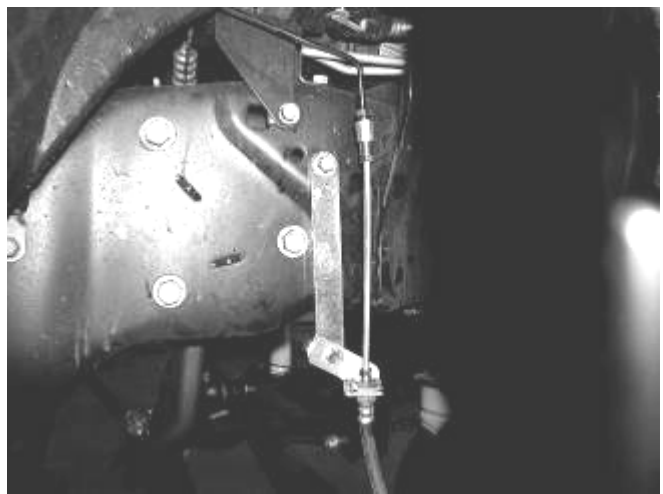

23. Locate the ABS sensor connection point in the back of the plastic wheel well. The end of the plug is slid into a clip on the liner that is mounted by two push in plastic plugs. Use care in removing the clip and the plastic plugs, they will be re-used. Using a drill with a 1/4" bit, drill the upper hole to 1/4". Re-insert the clip with the socket inverted, that way the end of the plug is now facing upward. Re-connect the sensor and continue to route the ABS line back into the stock mounting locations. Using WD-40, adjust the rubber grommets on the lines so they fit into the clamps on the frame and brake hose properly. **SEE PHOTO BELOW AND ON NEXT PAGE.**

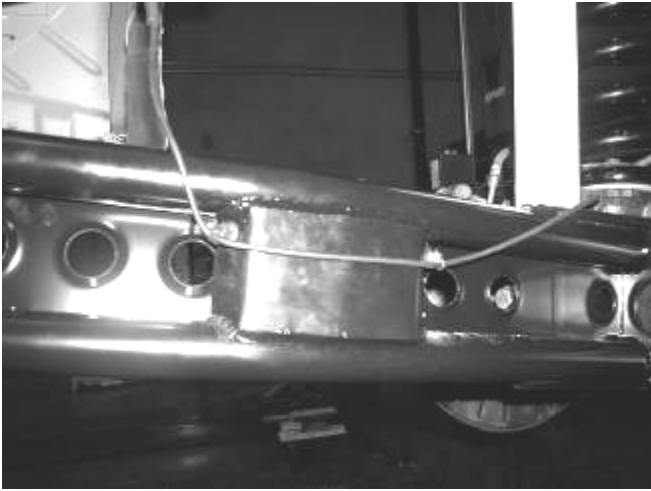
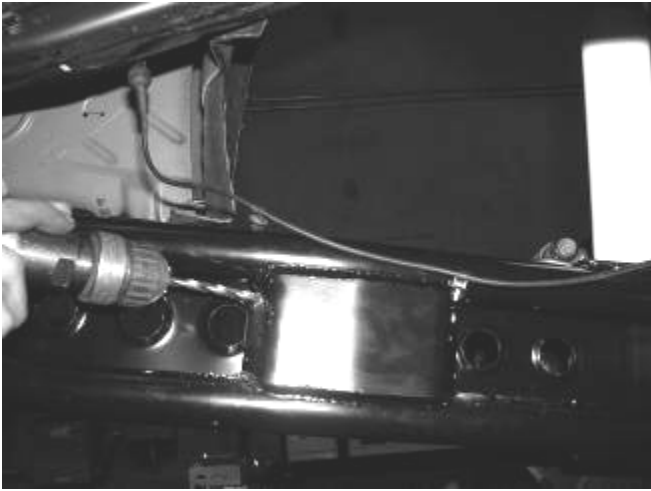

24. Locate the driver side tie rod end and cut off the adjusting sleeve bracket. Once free rotate the tie rod adjusting sleeve so the bolts are now on top of the tie rod. This will allow it to clear the sway bar. SEE PHOTOS BELOW.

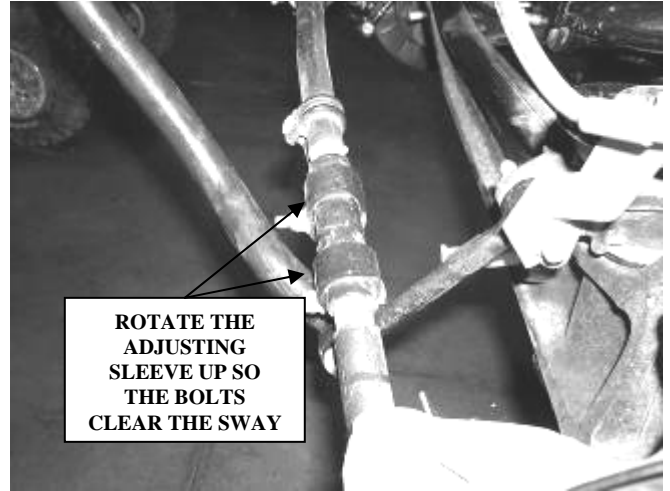

25. Locate FT3400-110D & P sway bar frame drop brackets and attach to the frame (AS SHOWN IN PHOTOS) where the sway bar was originally attached using the factory hardware. **MOUNT THE DRIVER SIDE BRACKET ON THE PASSENGER SIDE, AND THE PASSENGER SIDE ON THE DRIVER SIDE.** Using the supplied 7/16" X 1 1/4" hardware, attach the sway bar to the new drop brackets. Reattach the factory sway bar end links to the axle mounts using the original hardware (Torque to 40 ft. lbs. once the truck is on the ground; do not tighten while the suspension is in the air). The new drop brackets are slotted at both mounting points. For the 6" lift, position the frame mount and sway bar all the way forward toward the front of the truck and torque to 35 ft. lbs. For the 8" lift, position the frame mount and sway bar all the way rearward toward the back of the truck and torque to 35 ft. lbs. SEE PHOTO BELOW.



26. Locate FT30206 pitman arm spacer. Place the drag link through the bottom of the new pitman arm. Place the spacer on top of the pitman arm, followed by the factory nut. Torque the nut to 90 ft lbs and install the factory nut keeper and the new cotter pin. SEE PHOTO BELOW.



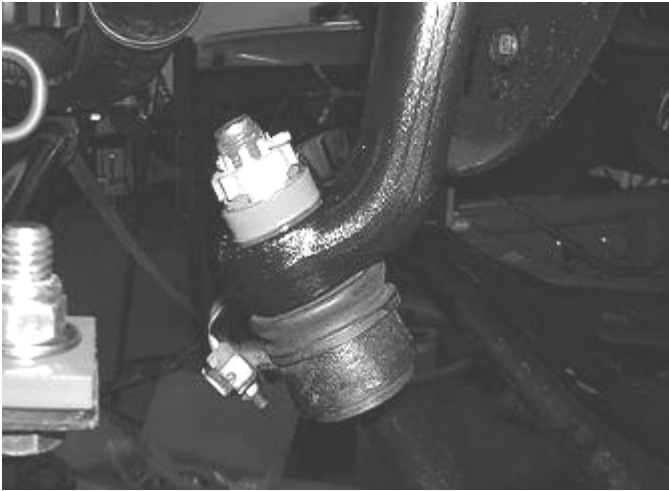

27. Locate the supplied FT30205 stabilizer bracket and install it in the factory location using the original hardware and torque to 65 ft. lbs. Re-connect the stabilizer to the new drop bracket and tighten to 45lbs. SEE PHOTO ON NEXT PAGE.

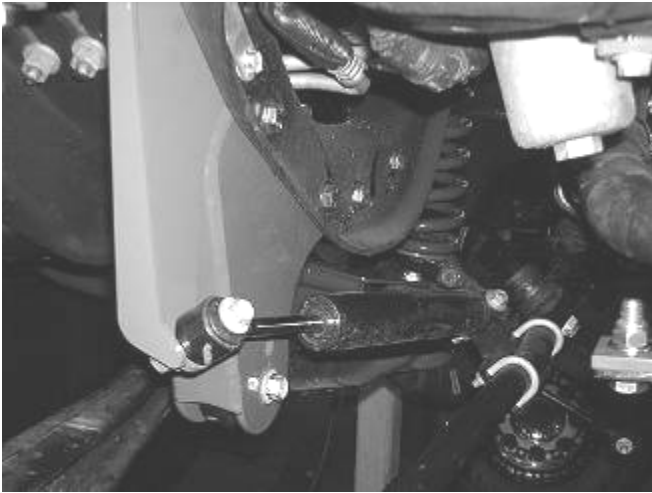

28. Locate the factory alignment cam. Completely remove the pinch bolt on the I-Beam and remove the factory alignment cam and discard. Locate the supplied FT594 alignment cam and place it into the I-Beam where the stock cam was. Re-install and tighten the pinch bolt. SEE PHOTO BELOW.



29. Install the front wheels and tires and torque to factory specs. Set the truck back on the ground. Re-torque all the hardware to recommended specs. Double check the toe-in and reset it to factory specs if necessary.
30. Recheck all bolts for proper torque. Recheck brake hoses and lines for proper clearances.
31. Grease all I-Beam pivot fittings and ball joints.
32. Torque lug nuts to wheel manufacturers specifications. Turn front tires left to right and check for appropriate tire clearance. Note- some oversized tires may require trimming of the front bumper & valance.
33. Check front-end alignment and set to factory specifications. We recommend driving the truck for fifty miles and then have it aligned to factory specs. Readjust headlights.
34. Reconnect the negative terminal of the battery.

## REAR INSTRUCTIONS

Follow the instructions included in the rear kit

**RETORQUE ALL NUTS, BOLTS AND LUGS AFTER 50 MILES AND PERIODICALLY THEREAFTER.**

For technical assistance call: 909-597-7800

## Product Warranty and Warnings-

Fabtech provides a Limited Lifetime Warranty to the original retail purchaser who owns the vehicle, on which the product was originally installed, for defects in workmanship and materials.

The Limited Lifetime Warranty excludes the following Fabtech items; bushings, bump stops, ball joints, tie rod ends, limiting straps, cross shafts, heim joints. These parts are subject to wear and are not considered defective when worn. They are warranted for 60 days from the date of purchase for defects in workmanship.

Take apart shocks are considered a serviceable shock with a one year warranty on leakage only. Service seal kits are available separately for future maintenance. All other shocks are covered under our Limited Lifetime Warranty.

Fabtech does not warrant any product for finish, alterations, modifications and/or installation contrary to Fabtech's instructions. Alterations to the finish of the parts including but not limited to painting, powdercoating, plating and/or welding will void all warranties. Some finish damage may occur to parts during shipping which is considered normal and is not covered under warranty.

Fabtech products are not designed nor intended to be installed on vehicles used in race applications or for racing purposes or for similar activities. (A "RACE" is defined as any contest between two or more vehicles, or any contest of one or more vehicle against the clock, whether or not such contest is for a prize). This warranty does not include coverage for police or taxi vehicles, race vehicles, or vehicles used for government or commercial purposes. Also excluded from this warranty are sales outside of the United States of America.

Installation of most suspension products will raise the center of gravity of the vehicle and will cause the vehicle to handle differently than stock. It may increase the vehicle's susceptibility to a rollover, on road and off road, at all speeds. Extreme care should be taken to operate the vehicle safely at all times to prevent rollover or loss of control resulting in serious injury or death. Fabtech front end Desert Guards may impair the deployment or operation of vehicles equipped with supplemental restraining systems/air bag systems and should not be installed if the vehicle is equipped as so.

Fabtech makes every effort to ensure suspension product compatibility with all vehicles listed in the catalog, but due to unknown auto manufacturers production changes and/or inconsistencies by the auto manufacturer, Fabtech cannot be responsible for 100% compatibility, including the fitment of tire and wheel sizes listed. The Tire and Wheel sizes listed in Fabtech's catalog are only a guideline for street driving with noted fender trimming. Fabtech is not responsible for damages to the vehicle's body or tires.

Fabtech's obligation under this warranty is limited to the repair or replacement, at Fabtech option, of the defective product only. All costs of removal, installation or re-installation, freight charges, incidental or consequential damages are expressly excluded from this warranty. Fabtech is not responsible for damages and/or warranty of other vehicle parts related or non related to the installed Fabtech product. This warranty is expressly in lieu of all other warranties expressed or implied. This warranty shall not apply to any product that has been subject to accident, negligence, alteration, abuse or misuse as determined by Fabtech.

Fabtech suspension components must be installed as a complete system including shocks as shown in our current catalog. All warranties will become void if Fabtech parts are combined and/or substituted with other aftermarket suspension products. Combination and/or substitution of other aftermarket suspension parts may cause premature wear and/or product failure resulting in an accident causing injury or death. Fabtech does not warrant products not manufactured by Fabtech.

Installation of Fabtech product may void the vehicles factory warranty; it is the consumer's responsibility to check with their local vehicle's dealer for warranty disposition before the installation of the product.

It is the responsibility of the distributor and/or the retailer to review all warranties and warnings of Fabtech products with the consumer prior to purchase.

Fabtech reserves the right to supercede, discontinue, change the design, finish, part number and, or application of parts when deemed necessary without written notice. Fabtech is not responsible for misprints or typographical errors within the catalog or price sheet.