



## INSTALLATION INSTRUCTIONS



### 2011-16 GM K2500HD 4WD DEF SKID PLATE

**FTS21225**

**Fabtech Motorsports** | 4331 Eucalyptus Ave. Chino, CA 91710

**Tech Line:** 909-597-7800 | **Fax:** 909-597-7185 | **Web:** [www.fabtechmotorsports.com](http://www.fabtechmotorsports.com)



## PARTS LIST

	<b>FTS21225</b>	<b>DEF TANK SKID PLATE</b>
1	FT20732BK	DEF TANK SKID PLATE
1	FT20497BK	FRAME MOUNT
1	FT20501	DUAL NUT TAB
1	FT30201	NUT TAB
1	FT20566	SHIM PLATE
1	FT20502	HARDWARE KIT
1	FT21225i	INSTRUCTIONS
1	FTAS12	STICKER FT BLUE 10X4
1	FTAS16	DRIVER WARNING DECAL
1	FTREGCARD	REGISTRATION CARD

	<b>FT20502</b>	<b>HARDWARE KIT</b>
3	50131251081	1/2-13 X 1.25 HEX BOLT
8	50000005081	1/2 SAE WASHER
3	50130004152	1/2-13 C-LOCK
2	43141001081	7/16-14 X 1" HEX BOLT G8
2	43000005081	WASHER 7/16 SAE G8 Z2
2	37161251081	3/8-16 X 1.25 HEX BOLT
4	37000005081	3/8 SAE WASHER
2	37160004152	3/8-16 C-LOCK
1	FTLOCK	THREAD LOCKING COMPOUND

## - TOOL LIST -

### Required Tools (Not Included)

Basic Hand Tools

Floor Jack, Jack Stands

Assorted Metric and S.A.E sockets, and Allen wrenches

Torque Wrench

Drill & Drill Bits

## - PRE-INSTALLATION NOTES -

**For technical assistance call: 909-597-7800 or e-mail: [info@fabtechmotorsports.com](mailto:info@fabtechmotorsports.com)**

### *Read this before you begin installation-*

Check all parts to the parts list above before beginning installation. If any parts are missing contact Fabtech at 909-597-7800 and a replacement part will be sent to you immediately.

Read all instructions thoroughly from start to finish before beginning the installation. If these instructions are not properly followed severe frame, driveline and / or suspension damage may occur.

## - INSTRUCTIONS -

1. Disconnect the negative terminal on the battery. Jack up the front end of the truck and support the frame rails with jack stands. **NEVER WORK UNDER AN UNSUPPORTED VEHICLE!**

**REFER TO FIGURE 7 FOR STEPS 2-9**

2. Locate the skid plate (FT20732BK) and the frame mount (FT20497BK). Connect the frame mount to the skid plate using the supplied 3/8" hardware, leave loose. **SEE FIGURE 1**

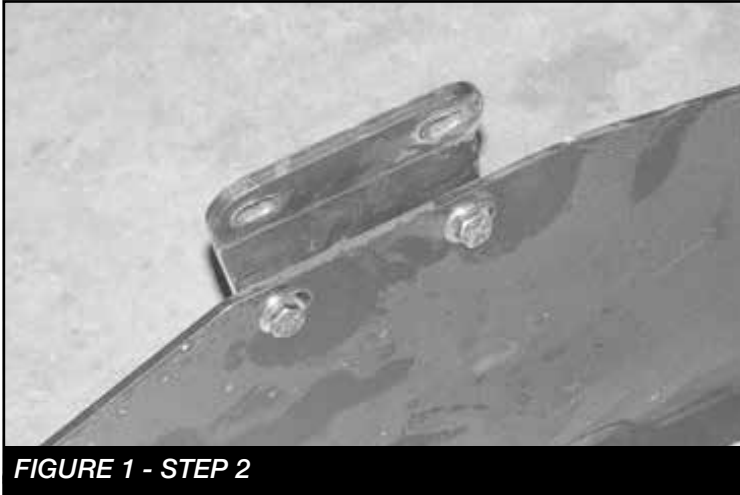

**FIGURE 1 - STEP 2**

3. Support the skid plate under the DEF tank with jack stands and locate the FT20501 Nut plate. **SEE FIGURE 2**

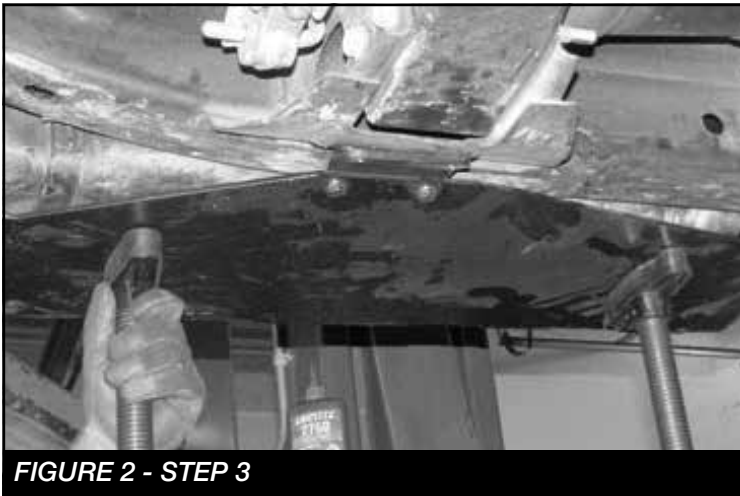

**FIGURE 2 - STEP 3**

4. Using the FT20501 Nut plate, mount the skid plate to the factory crossmember using the supplied 7/16" hardware. Leave loose at this time **SEE FIGURE 3**



**FIGURE 3 - STEP 4**

5. Using the FT30201 (Nut Tab) mount the front of the skid plate to the frame with a 1/2" bolt and washer. **SEE FIGURE 4**

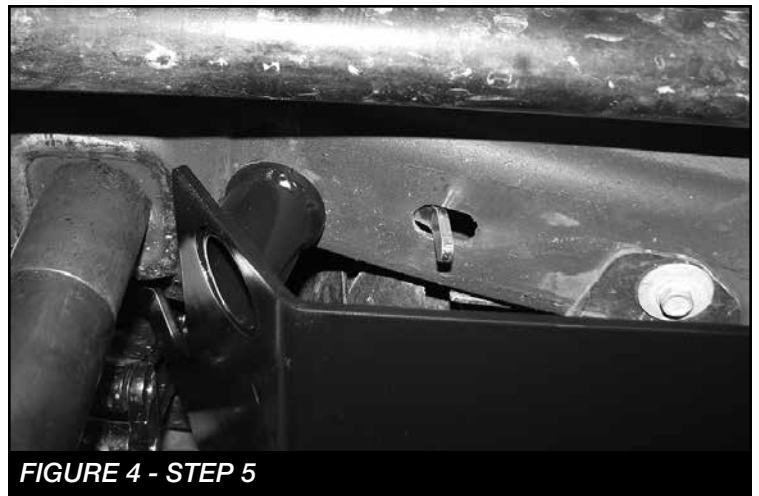

**FIGURE 4 - STEP 5**

6. Mark and Drill the front 1/2" hole in the body mount using the skid plate as a drill guide. **SEE FIGURE 5**



**FIGURE 5 - STEP 6**

7. Mount the front of the skid plate using 1/2" Bolt, nut and washers on the location you previously drilled. **SEE FIGURE 6**

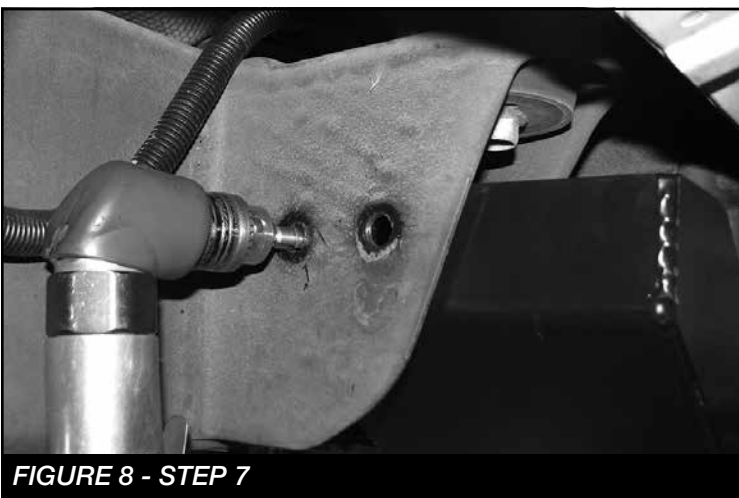

**FIGURE 6 - STEP 7**

8. Locate the rear body mount drilling template and cut it out. Place the template on the body mount to mark the driller holes. Drill the 1/2 holes and bolt it up with 1/2"x hardware. **SEE FIGURES 7-9**



**FIGURE 7 - STEP 7**



**FIGURE 8 - STEP 7**

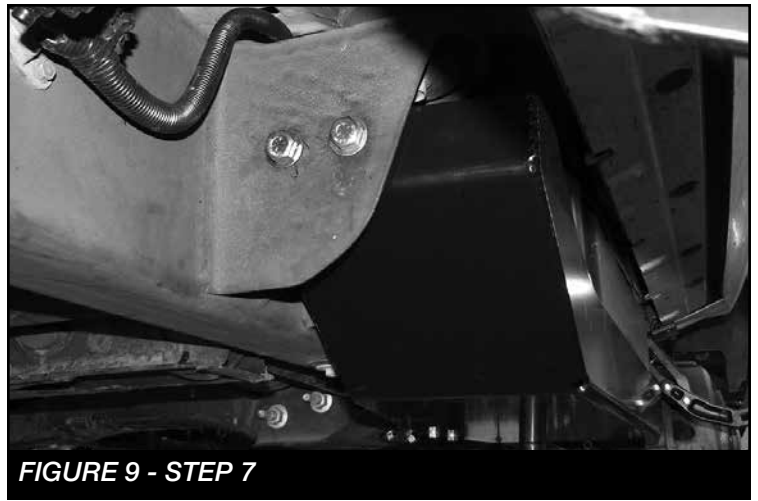

**FIGURE 9 - STEP 7**

9. Torque all the hardware to the specifications in **FIGURE 10**.
10. Complete product registration card and mail to Fabtech in order to receive future safety and technical bulletins on this suspension.

**RE-TORQUE ALL NUTS, BOLTS AND LUGS AFTER 50 MILES AND PERIODICALLY THEREAFTER.**

For technical assistance call: 909-597-7800

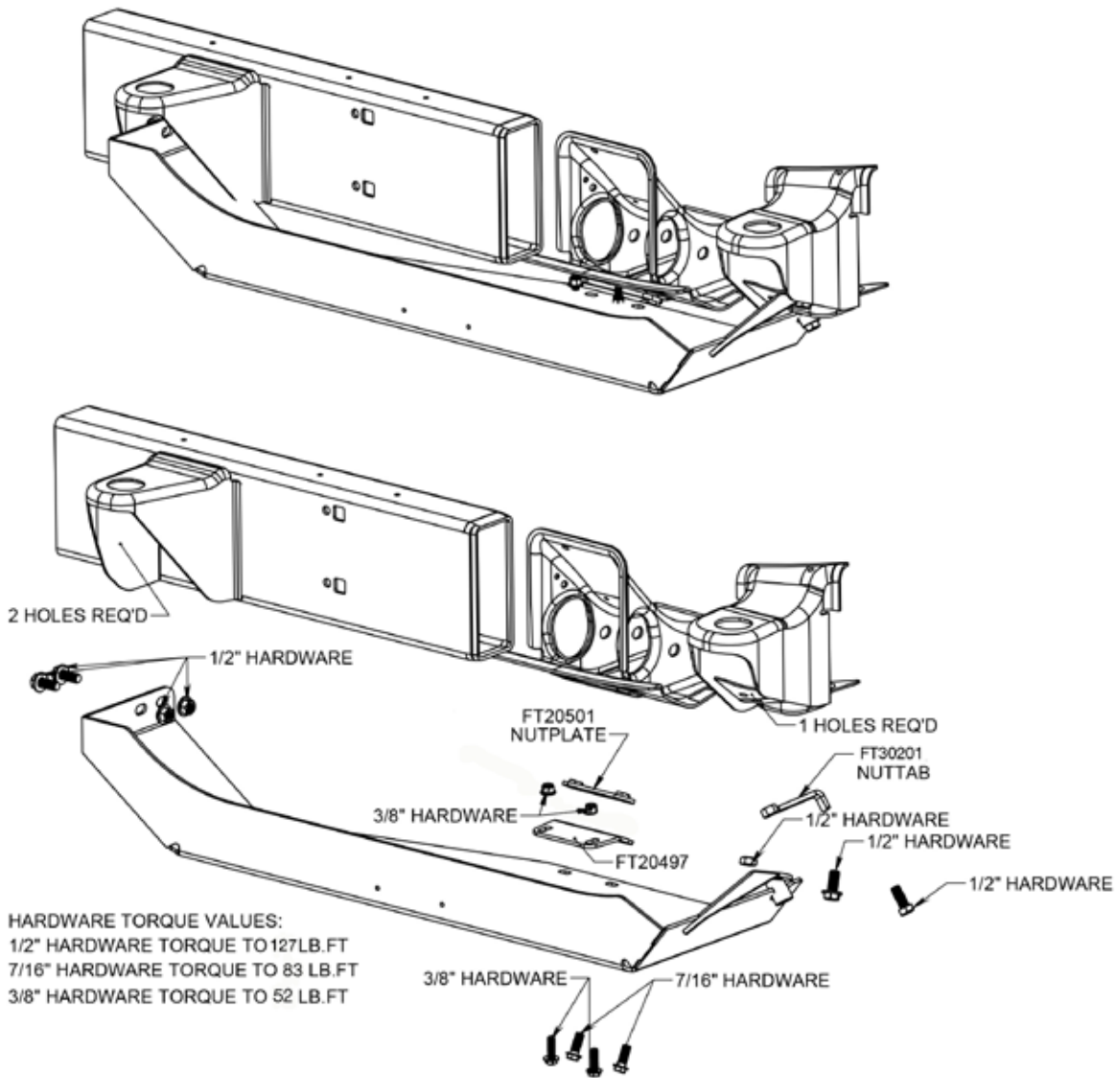
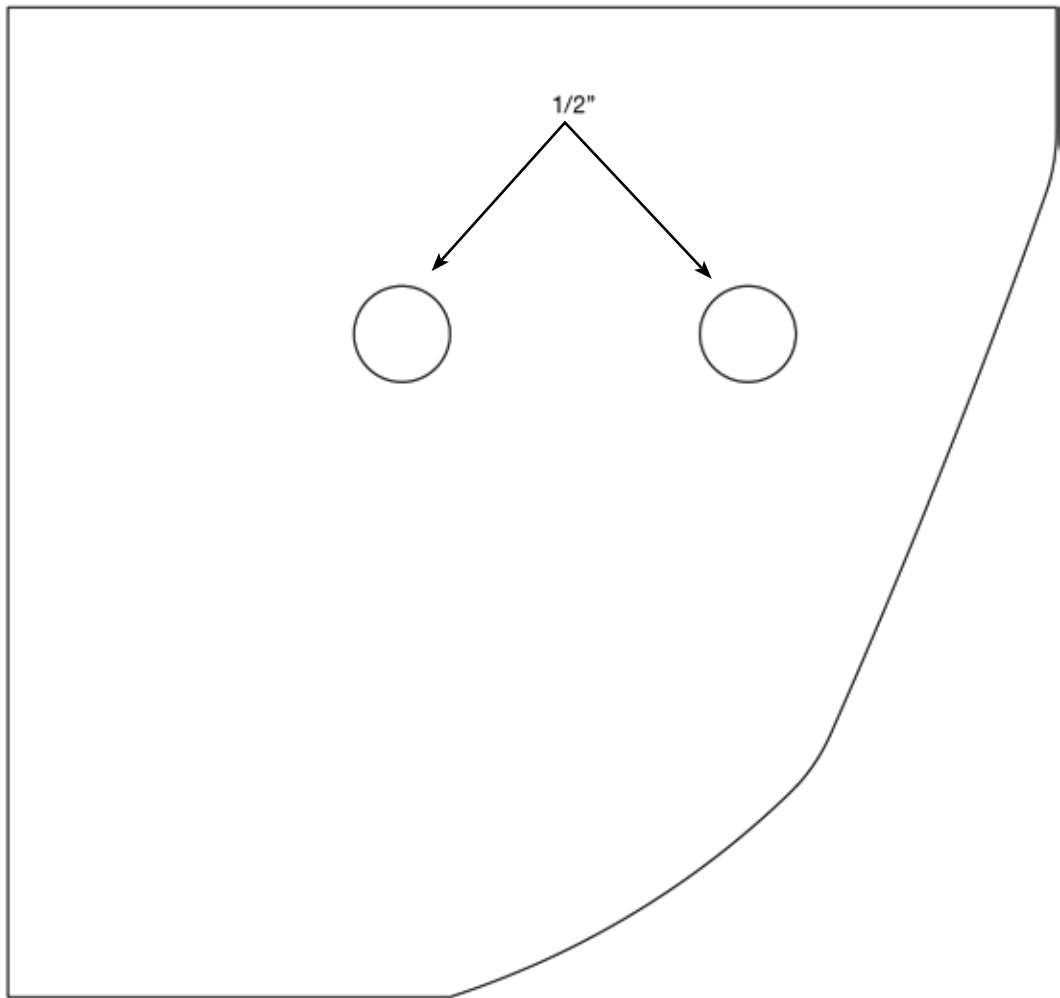

FIGURE 10





## - Product Warranty and Warnings -

Fabtech provides a Limited Lifetime Warranty to the original retail purchaser who owns the vehicle, on which the product was originally installed, for defects in workmanship and materials.

The Limited Lifetime Warranty excludes the following Fabtech items; bushings, bump stops, ball joints, tie rod ends, limiting straps, cross shafts, heim joints and driveshafts. These parts are subject to wear and are not considered defective when worn. They are warranted for 60 days from the date of purchase for defects in workmanship.

Dirt Logic and Performance Coilover take apart shocks are considered a serviceable shock with a one year warranty on leakage only. Service seal kits are available separately for future maintenance. All other shocks are covered under our Limited Lifetime Warranty.

Fabtech does not warrant any product for finish, alterations, modifications and/or installation contrary to Fabtech's instructions. Alterations to the finish of the parts including but not limited to painting, powder coating, plating and/or welding will void all warranties. Some finish damage may occur to parts during shipping, which is considered normal and is not covered under warranty.

Fabtech products are not designed nor intended to be installed on vehicles used in race applications or for racing purposes or for similar activities. (A "RACE" is defined as any contest between two or more vehicles, or any contest of one or more vehicle against the clock, whether or not such contest is for a prize). This warranty does not include coverage for police or taxi vehicles, race vehicles, or vehicles used for government or commercial purposes. Also excluded from this warranty are sales outside of the United States of America.

Installation of most suspension products will raise the center of gravity of the vehicle and will cause the vehicle to handle differently than stock. It may increase the vehicle's susceptibility to a rollover, on road and off road, at all speeds. Extreme care should be taken to operate the vehicle safely at all times to prevent rollover or loss of control resulting in serious injury or death. Fabtech front end Desert Guards may impair the deployment or operation of vehicles equipped with supplemental restraining systems/air bag systems and should not be installed if the vehicle is equipped as so.

Fabtech makes every effort to ensure suspension product compatibility with all vehicles listed on the website, but due to unknown auto manufacturer's production changes and/or inconsistencies by the auto manufacturer, Fabtech cannot be responsible for 100% compatibility, including the fitment of tire and wheel sizes listed. The Tire and Wheel sizes listed in Fabtech's website are only a guideline for street driving with noted fender trimming. Fabtech is not responsible for damages to the vehicle's body or tires. Fabtech is not responsible for premature wear of factory components due to the installation of oversized tires and wheels.

Fabtech's obligation under this warranty is limited to the repair or replacement, at Fabtech option, of the defective product only. All costs of removal, installation or re-installation, freight charges, incidental or consequential damages are expressly excluded from this warranty. Fabtech is not responsible for damages and/or warranty of other vehicle parts related or non related to the installed Fabtech product. This warranty is expressly in lieu of all other warranties expressed or implied. This warranty shall not apply to any product that has been subject to accident, negligence, alteration, abuse or misuse as determined by Fabtech.

Fabtech suspension components must be installed as a complete system including shocks as shown on our website. All warranties will become void if Fabtech parts are combined and/or substituted with other aftermarket suspension products. Combination and/or substitution of other aftermarket suspension parts may cause premature wear and/or product failure resulting in an accident causing injury or death. Fabtech does not warrant products not manufactured by Fabtech.

Depending on the condition of the factory suspension components retained after the installation of a Fabtech suspension not all vehicles may have the same ride stance front to rear as described in the website. The blue color of suspension components shown in all Fabtech photographs are for display purposes only. Majority of all Fabtech components will be black specifically where noted with part numbers ending in BK.

Installation of Fabtech product may void the vehicles factory warranty; it is the consumer's responsibility to check with their local vehicle's dealer for warranty disposition before the installation of the product. Some state laws may prohibit modification of suspension to a vehicle in whole or in part. It is the responsibility of the installer and consumer to consult local laws prior to the installation of any Fabtech suspension product to comply with such written laws.

It is the responsibility of the distributor and/or the retailer to review all warranties and warnings of Fabtech products with the consumer prior to purchase.

Fabtech reserves the right to super cede, discontinue, change the design, finish, part number and/or application of parts when deemed necessary without written notice. Fabtech is not responsible for misprints or typographical errors within the website or price sheet. For the most recent Product Warranty and Warnings visit our website [www.fabtechmotorsports.com](http://www.fabtechmotorsports.com)