



# **INSTALLATION INSTRUCTIONS**

## **2017-18 FORD F450/550 4WD 6" RADIUS ARM SYSTEM**

**FT22257i**

**Fabtech Motorsports** | 4331 Eucalyptus Ave. Chino, CA 91710

**Tech Line:** 909-597-7800 | **Fax:** 909-597-7185 | **Web:** [www.fabtechmotorsports.com](http://www.fabtechmotorsports.com)

<b>FTS22251 6" FORD F250/350 FRONT COILS</b>		
2	FT30733	6" FRONT COIL

<b>FTS22274 F450/550 REAR BOX KIT</b>		
2	FT30784	SWAY BAR END LINK
2	FT30750	REAR BUMPSTOP EXTENSION
4	FT759U	U-BOLT RD 3/4-16 X 21.00 X 3.50
2	FTBK65	LIFT BLOCK
1	FTS419	DRIVE SHAFT SHIM KIT
1	FT30779	HARDWARE SUBASSEMBLY

<b>FTS22257 6" RADIUS ARM SYSTEM (2017)</b>		
1	FT30775	PITMAN ARM
2	FT30654	6" BUMP STOP EXT
1	FT30125BK	RADIUS ARM (DRIVER)
1	FT30126BK	RADIUS ARM (PASS)
1	FT30724	TRAC BAR DROP BRACKET
1	FT30668	HARDWARE KIT
1	FT30778	HARDWARE SUBASSEMBLY
1	FT30672	STEERING STABILIZER BRACKET
1	FT30686	STEERING STABILIZER CLEVIS MOUNT
1	FT3400-112D	SWAY BAR DROP (PASSENGER)
1	FT3400-112P	SWAY BAR DROP (DRIVER)
2	FT30456	SWAY BAR BRACKET (AXLE)

<b>FTS22280 6" RADIUS ARM SYSTEM (2018)</b>		
1	FT30801	PITMAN ARM
2	FT30654	6" BUMP STOP EXT
1	FT30125BK	RADIUS ARM (DRIVER)
1	FT30126BK	RADIUS ARM (PASS)
1	FT30724	TRAC BAR DROP BRACKET
1	FT30668	HARDWARE KIT
1	FT30778	HARDWARE SUBASSEMBLY
1	FT30672	STEERING STABILIZER BRACKET
1	FT30686	STEERING STABILIZER CLEVIS MOUNT
1	FT3400-112D	SWAY BAR DROP (PASSENGER)
1	FT3400-112P	SWAY BAR DROP (DRIVER)
2	FT30456	SWAY BAR BRACKET (AXLE)

<b>SHOCK OPTIONS</b>		
2	FTS7188	PERFORMANCE SHOCK (FRONT)
2	FTS7266	PERFORMANCE SHOCK (REAR)
2	FTS6063	STEALTH SHOCK (FRONT)
2	FTS6188	STEALTH SHOCK (REAR)
2	FTS810382	DIRT LOGIC 2.25 SHOCK (FRONT)
2	FTS810052	DIRT LOGIC 2.25 SHOCK (REAR)
1	FTS835235D	DIRT LOGIC 4.0 RESI COILOVER (DRIVER)
1	FTS835235P	DIRT LOGIC 4.0 RESI COILOVER (PASS)

<b>FT30779</b>		<b>HARDWARE SUBASSEMBLY</b>
2	FT160	SLEEVE .750 X .594 X .500
8	FT1004	SWAY BAR BUSHING HALF
1	FT50089	SLEEVE .625 X .507 X 1.480 (4-PACK)
1	FT30754	HARDWARE KIT
1	FTAS12	STICKER FT BLUE 10X4 DIE CUT
1	FTAS16	DRIVER WARNING DECAL
1	FTREGCARD	REGISTRATION CARD

<b>FT30778</b>		<b>HARDWARE SUBASSEMBLY</b>
4	FT1006	BUSHING
2	FT102	SLEEVE
1	FT22257i	INSTRUCTIONS
1	FT292	ALIGNMENT CAM KIT
1	FT30258	SECTOR SHAFT NUT
1	FT30604	SPACER
2	FT30660	BRAKE LINE TAB
2	FT50290	BUMP STOP NUT TAB
1	FTAS12	STICKER FT BLUE 10X4 DIE CUT
1	FTAS16	DRIVER WARNING DECAL
1	FTREGCARD	REGISTRATION CARD
1	FTLUBE	URETHANE GREASE
2	HEX BOLT	1/2-13 X 1-1/2" BOLT
2	C-LOCK NUT	1/2-13 C-LOCK NUT
4	WASHER	1/2 SAE WASHER

<b>FT30668 - HARDWARE KIT</b>		<b>LOCATION</b>
8	7/16 SAE WASHER G8 ZINC	SWAY BAR
4	7/16-14 C-LOCK NUT ZINC	
4	7/16-14 X 1 1/4 HEX HD	
2	3/8-16 X 1" HEX BOLT	BRAKE LINE
4	3/8" SAE WASHER	
2	3/8-16 NYLOCK NUT	
2	1/4 SAE WASHER	
1	1/4-20 C-LOCK NUT	
1	1/4-20 X 3/4 HEX BOLT G5 ZINC	
2	1/2-13 X 1-1/4 HEX BOLT	BUMP STOP
2	1/2-13 X 1-1/2 HEX BOLT	
6	1/2 SAE WASHER	
2	1/2-13 C-LOCK NUT	
1	COTTER PIN	
1	M12-1.75 X 70MM HEX BOLT	STEERING STABILIZER
2	M12 WASHER	
1	M12-1.75 C-LOCK	
1	9/16-12 NYLOCK NUT	
3	9/16 SAE WASHER	
1	THREAD LOCKING COMPOUND 1 MIL	
1	HOSE CLAMP	

<b>FT30754 - HARDWARE KIT</b>		<b>LOCATION</b>
8	3/4-16 NYLOCK NUT	UBOLTS
8	3/4 SAE WASHER	
4	1/2-13 X 2-1/2" HEX BOLT	SWAY BAR
12	1/2 SAE WASHER	
6	1/2-13 C-LOCK NUT	
2	1/2-13 X 1-1/4 HEX BOLT	BUMPSTOP
1	THREAD LOCKING COMPOUND	

## - TOOL LIST -

### ***Required Tools (Not Included)***

- |  |                      |
|--|----------------------|
| -Basic Hand Tools                                      | -Basic Hand Tools    |
| -Assorted Metric and S.A.E sockets, and Allen wrenches | -Floor Jack          |
| -Torque Wrench   | -Jack Stands         |
| -Die Grinder w/ Cutoff Wheel or Sawzall                | -Drill               |
| - 1-1/4" Hole Saw                                      | -Assorted Drill Bits |

## - PRE-INSTALLATION NOTES -

For technical assistance call: **909-597-7800** or e-mail: **info@fabtechmotorsports.com**

### ***READ THIS BEFORE YOU BEGIN INSTALLATION -***

Check all parts to the parts list above before beginning installation. If any parts are missing contact Fabtech at 909-597-7800 and a replacement part will be sent to you immediately.

Read all instructions thoroughly from start to finish before beginning the installation. If these instructions are not properly followed severe frame, driveline and / or suspension damage may occur.

Check your local city and state laws prior to the installation of this system for legality. Do not install if not legal in your area.

Prior to the installation of this suspension system perform a front end alignment and record. Do not install this system if the vehicle alignment is not within factory specifications. Check for frame and suspension damage prior to installation.

The installation of this suspension system should be performed by two professional mechanics.

This suspension must be installed with Fabtech shock absorbers.

Use the provided thread locking compound on all hardware.

**WARNING-** Installation of this system will alter the center of gravity of the vehicle and may increase roll over as compared to stock.

Vehicles that receive oversized tires should check ball joints, uniballs, tie rods ends, pitman arm and idler arm every 2500-5000 miles for wear and replace as needed.

Verify differential fluid is at manufactures recommended level prior to kit installation. Installation of the kit will reposition the differential and the fill plug hole may be in a different position. (For example, if the manufacture recommends 3 quarts of fluid, make sure the diff has 3 quarts of fluid). Check your specific manual for correct amount of fluid.

### ***Recommend Tires and Wheels:***

- Use 37/12.50R17 tire w/ 17x9 wheels w/ 4-3/4" BS w/ minor trimming
- Use 37/12.50R18 tire w/ 18x9 wheels w/ 4-3/4" BS w/ minor trimming
- Use 37/13.50R20 tire w/ 20x9 wheels w/ 5" BS w/ minor trimming

### ***FOOTNOTES -***

- SOME MODELS MAY NOT SIT LEVEL AFTER INSTALL

# - INSTRUCTIONS -

## FRONT SUSPENSION

1. Disconnect the negative terminal on the battery. Jack up the front end of the truck and support the frame rails with jack stands. **NEVER WORK UNDER AN UNSUPPORTED VEHICLE!** Remove the front tires.
2. Disconnect the sway bar from the sway bar end links and frame. Remove sway bar. Save hardware. **SEE FIGURE 1**



FIGURE 1 - STEP 2

3. Disconnect the brake line from the frame and axle on both driver and passenger sides. Save hardware. **SEE FIGURES 2-3**

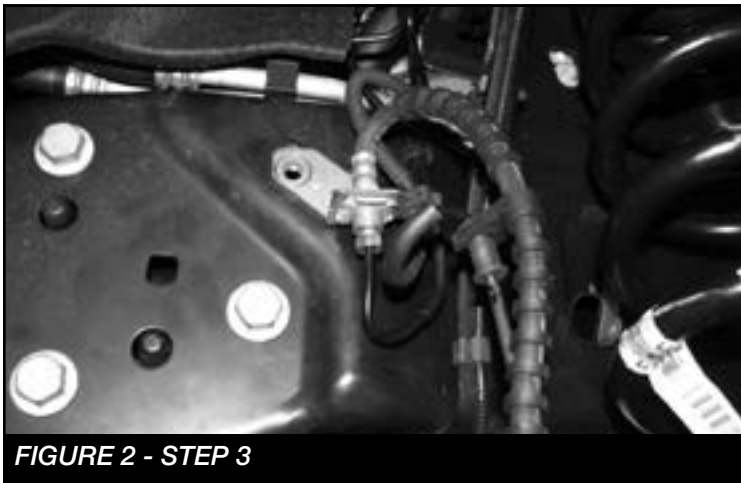

FIGURE 2 - STEP 3



FIGURE 3 - STEP 3

4. Remove the front shocks and discard, save hardware.
5. Lower the front axle allowing the coil springs to come free of tension and remove the coil springs. **EXERCISE EXTREME CAUTION WHEN WORKING WITH COIL SPRINGS UNDER LOAD!**
6. Disconnect the factory steering stabilizer from the frame mount. Remove the steering stabilizer frame bracket. Discard the frame bracket. Save all hardware.
7. Remove the drag link from the pitman arm. **Use care not to damage the threads on the drag link.**
8. Disconnect the trac bar from the frame bracket. Remove the trac bar bracket from the frame, save the original hardware and discard the factory trac bar bracket.
9. Remove the factory pitman arm from the steering box using a large pitman arm puller. Discard hardware and arm.
10. Install FT30775 or FT30801 (Pitman Arm) using the supplied FT30258 (Sector shaft nut). Torque to 350 ft-lbs. **NOTE: This is a one time only use nut. If remove, it must be discarded.**
11. Locate FT30724 (Track Bar Bracket). Attach to the frame using the original hardware in the same position. Torque bolts to 120 ft-lbs. **DO NOT ATTACH THE TRAC BAR TO THE FRAME BRACKET AT THIS TIME. SEE FIGURES 4-5**



FIGURE 4 - STEP 11

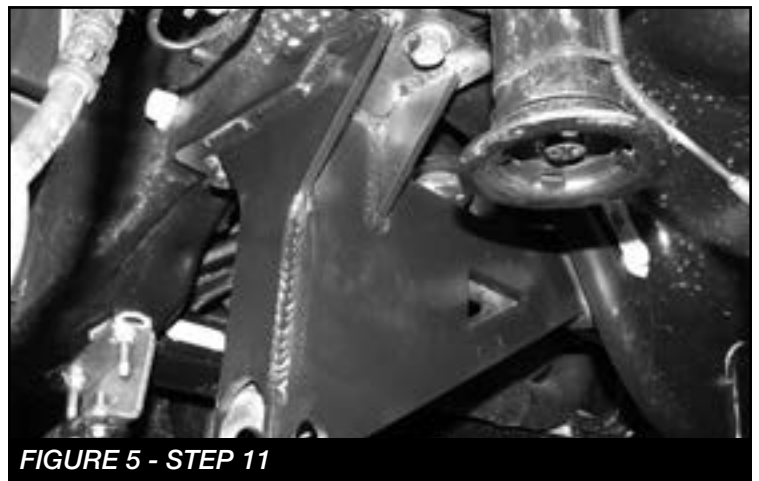
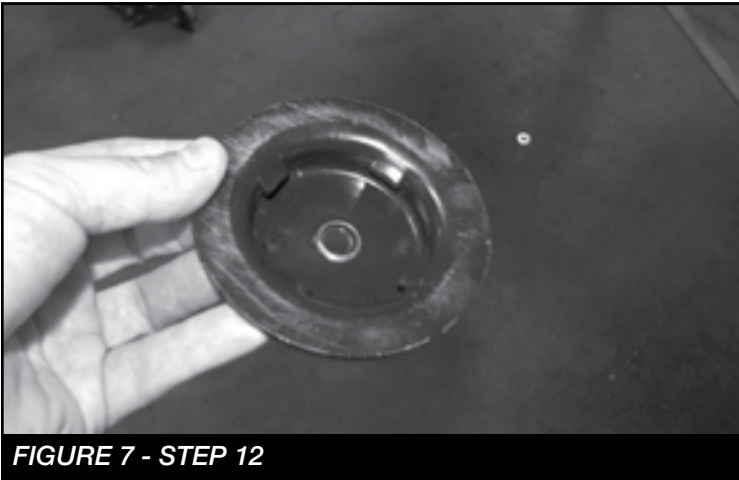

FIGURE 5 - STEP 11

12. Working from both sides of the truck, locate and remove the factory front bump stops and save. Pull on the bump stop itself to free from the cup. Remove the factory mounting cup from the frame and discard the hardware. Drill out the center hole on the factory cup to 1/2". **SEE FIGURES 6-7**

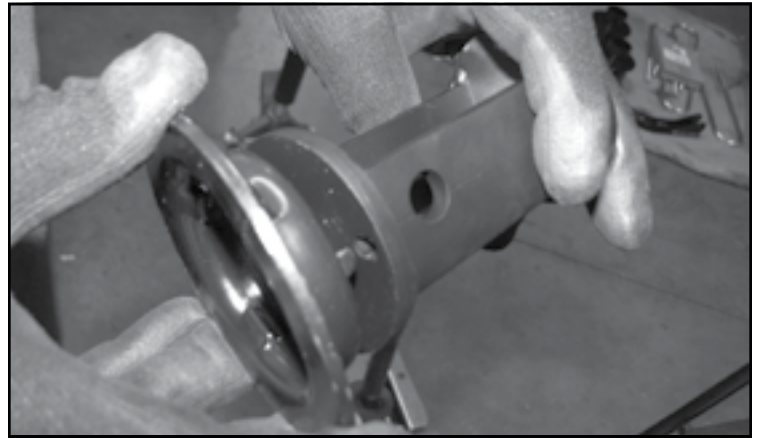

**FIGURE 6 - STEP 12**



**FIGURE 7 - STEP 12**

13. Install FT30654 (Bump Stop Extension) onto the factory cup using the supplied 1/2" x 1-1/4" hardware and set aside. Torque to 127 ft-lbs. **SEE FIGURE 8**



**FIGURE 8 - STEP 13**

14. Locate the factory bump stop mounting hole. Measure 3" straight up from the bottom of the frame. Mark and drill a 1-1/4" hole using a hole saw into the frame. **SEE FIGURES 9-10**

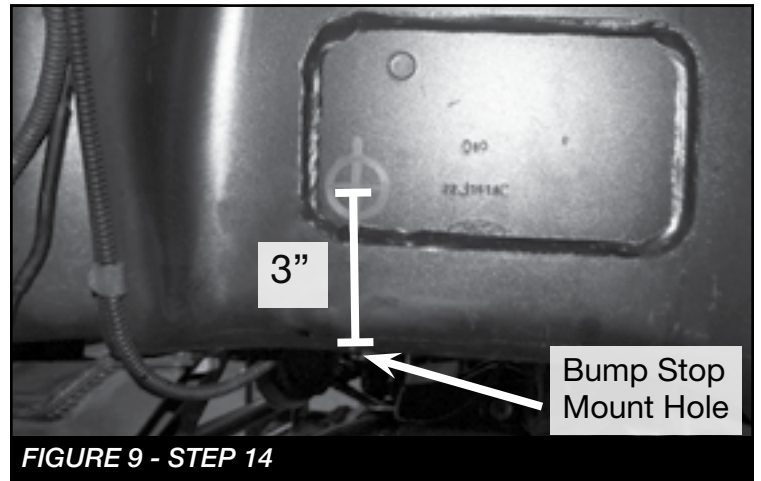

**FIGURE 9 - STEP 14**



**FIGURE 10 - STEP 14**



15. Drill out the factory bump stop mount hole to 1/2". **SEE FIGURE 11**

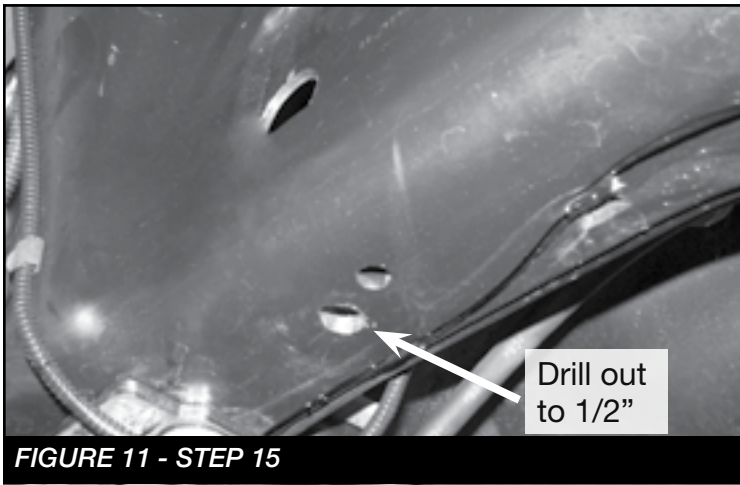

16. Using FT50290 (Nut Tab) and 1/2 X 1-1/2" bolt and washer. Mount the new bump stop extension to the frame. Route the Nut tab through the 1-1/4" hole that was made in Step 11. Torque to 127 ft-lbs. **SEE FIGURE 12**

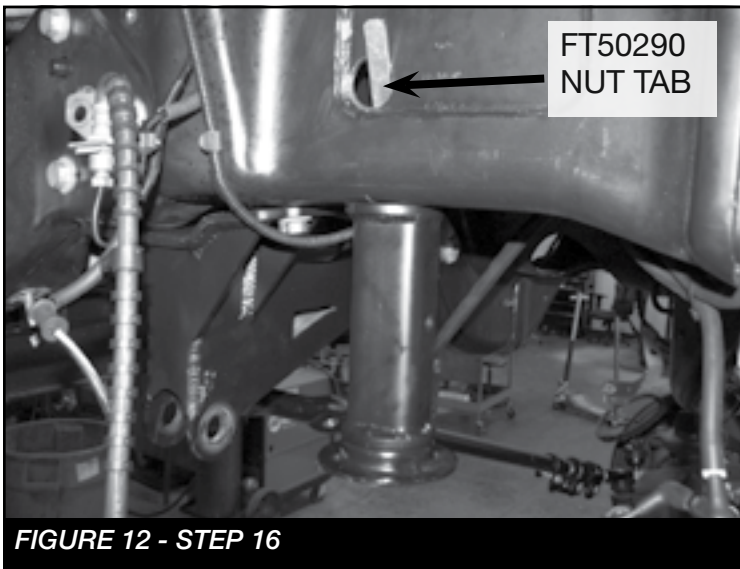

**REPEAT BUMP STOP INSTALLATION ON PASSENGER SIDE**

17. With the front axle still supported by the floor jack, remove the Driver side factory radius arm. Save the factory hardware.
18. Install FT1006 (Bushings) & FT102 (Sleeve) into the FT30125BK (Driver Radius Arm) using the supplied Urethane grease.

19. Install the new radius arm using the factory hardware at the frame and upper axle mount. Use the supplied FT292 (Alignment cam kit bolt) at the lower axle location. Torque to 300 ft-lbs. **SEE FIGURES 13-14**

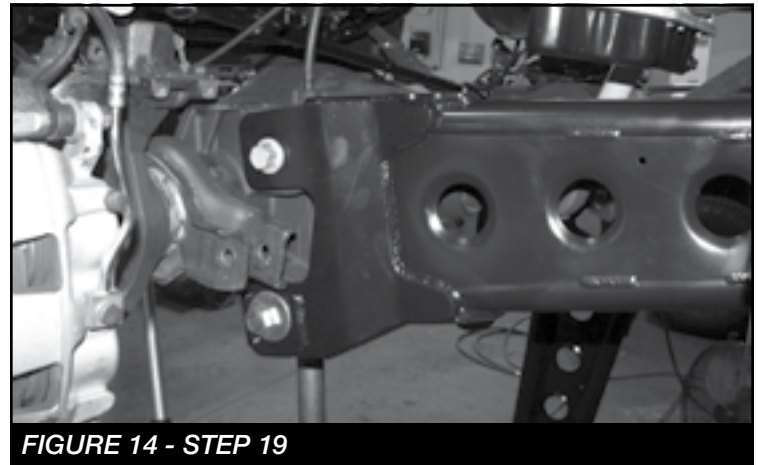

- **REPEAT STEPS 17-19 ON PASSENGER SIDE**
- **IF INSTALLING A COILOVER CONVERSION KIT, DO SO NOW AND SKIP TO STEP 22**

20. Install FT30733 (Coil Spring) using the factory upper isolator. **SEE FIGURE 15**

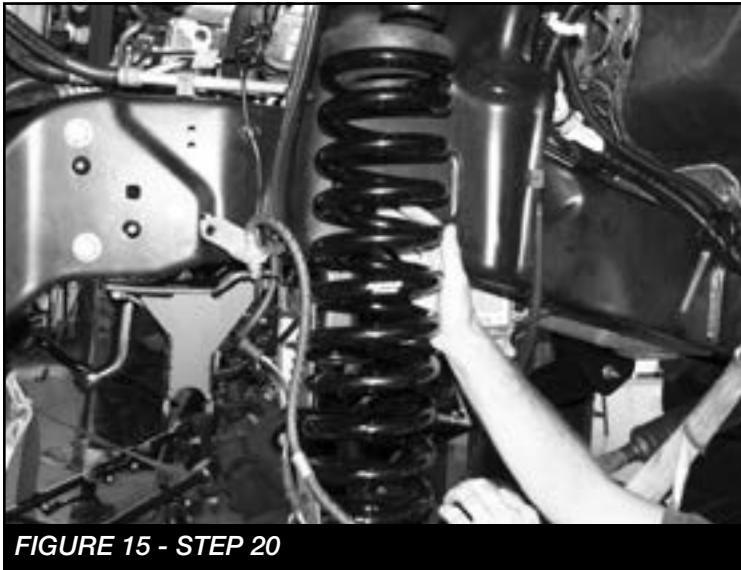

21. Install the new front shocks FTS7188, FTS6188 or FTS810382 with the supplied bushing kits. Using the factory hardware. **NOTE: Install a supplied 9/16" washer at the lower mount to fill up the gap between the bushing and mount.** Due to vehicle variances the top of the lower shock mount may need to be sanded down to clear the shock body only if installing Stealth shocks. **SEE FIGURE ON LAST PAGE.**

22. Reinstall the track bar to the new frame bracket. Torque to 400 ft-lbs. Install the draglink to the new Fabtech pitman arm using the factory hardware and the new supplied cotter pin. **NOTE: The drag link will need to be rotated 180 degrees and installed from the bottom side of the pitman arm.** **SEE FIGURE 16**



23. **(DRIVER SIDE)** Install FT30660 (Brake line bracket) to the factory brake line tab using the supplied 3/8" hardware. Next, install the bracket to the frame using the factory hardware. Torque hardware to 52 ft-lbs. **SEE FIGURE 17**



24. **(PASSENGER SIDE)** Install FT30660 (Brake line bracket) to the factory brake line tab using the supplied 3/8" hardware (Use lower hole). Next, using the supplied rubber clamp and 1/4" hardware, attach the ABS line to the upper hole on the FT30660 bracket. Re attach to the frame using the factory hardware. Torque 3/8" & factory hardware to 52 ft-lbs. Torque 1/4" hardware to 14 ft-lbs. **SEE FIGURE 18**

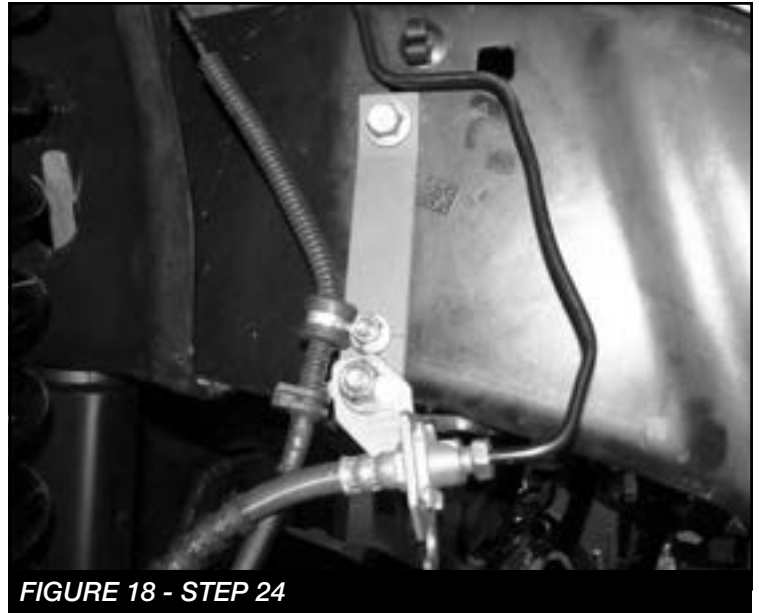



25. Install FT30672 (steering stabilizer drop bracket) in the factory location using the factory hardware. Torque to 127 ft-lbs. **SEE FIGURE 19**

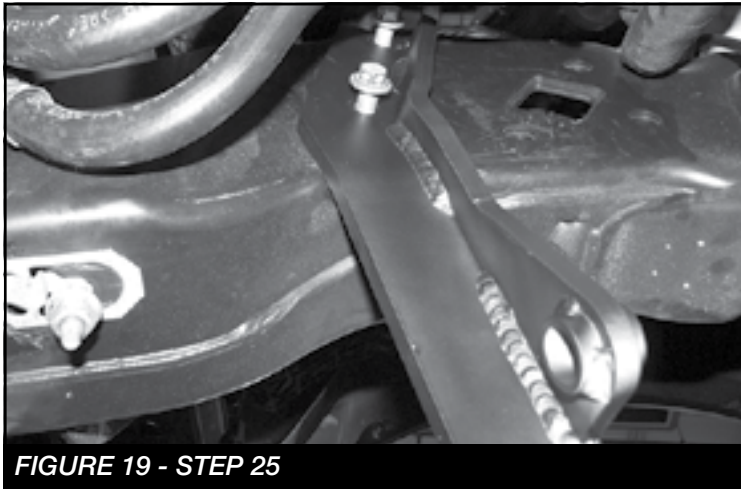

FIGURE 19 - STEP 25

26. Install FT30686 (Stabilizer Clevis) on the factory steering stabilizer using the supplied M12 hardware. **NOTE: Install FT30604 (spacer) like shown in the figure below.** Install the stabilizer using the supplied 9/16" washer and nut to the drag link. Using the factory hardware install the tapered end into the new Fabtech bracket. Torque to 127 ft-lbs. **SEE FIGURE 20**



FIGURE 20 - STEP 26

27. Install FT3400-112P (Driver) & FT3400-112D (Passenger) Sway bar drop brackets using the factory hardware. Reinstall the front sway bar to the end links using the supplied 7/16" hardware torque all hardware to 83 ft-lbs. Reconnect the sway bar to the end links. Torque to 52 ft-lbs. Remove the factory end links and install FT30456 to the axle using the supplied 1/2-13 X 1-1/2" hardware then reinstall the endlink to the new bracket and sway bar. **SEE FIGURES 21-22**

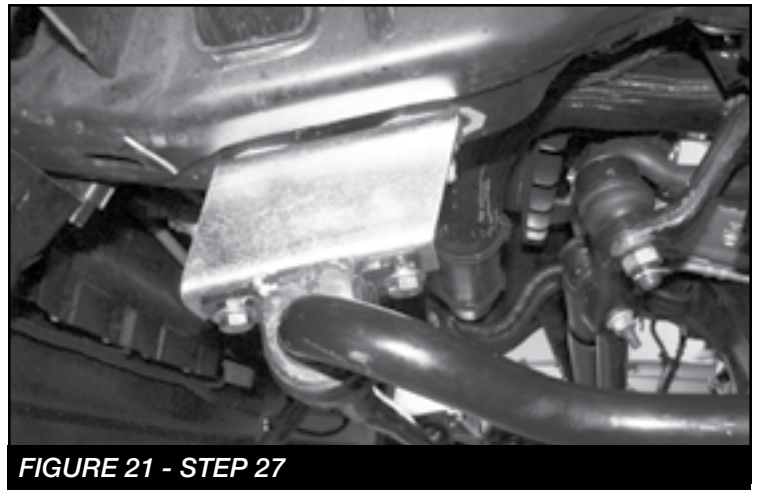

FIGURE 21 - STEP 27

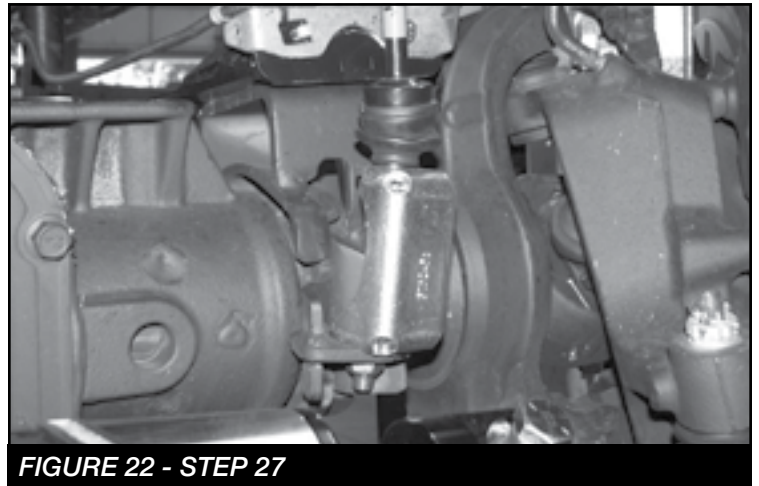

FIGURE 22 - STEP 27

28. Install the lower brake line bracket to the lower spring perch using the factory hardware. Torque to 29 ft-lbs.
29. Install the front tires and wheels. Torque lug nuts to wheel manufacturer's specifications.

### REAR SUSPENSION

30. Jack up the rear end of the vehicle and support the frame rails with jack stands. Release the parking brake at this time. Supporting the rear differential, remove the rear shock and u-bolts. Disconnect the sway bar end link from the sway bar then lower axle down and remove the blocks. Use care not to over extend the brake hose. **SEE FIGURE 23**



FIGURE 23 - STEP 30

31. Install the new FTBK65 (Block) onto the axle. Jack up the rear axle so the block is seated in with the spring pin. Next, install the FT759U ubolts. Torque to 275 ft-lbs in a diagonal pattern.

32. Remove the sway bar end link and factory bracket from the frame. Save hardware. Remove end link from the bracket and discard. The bracket will be re-used. **SEE FIGURE 24**

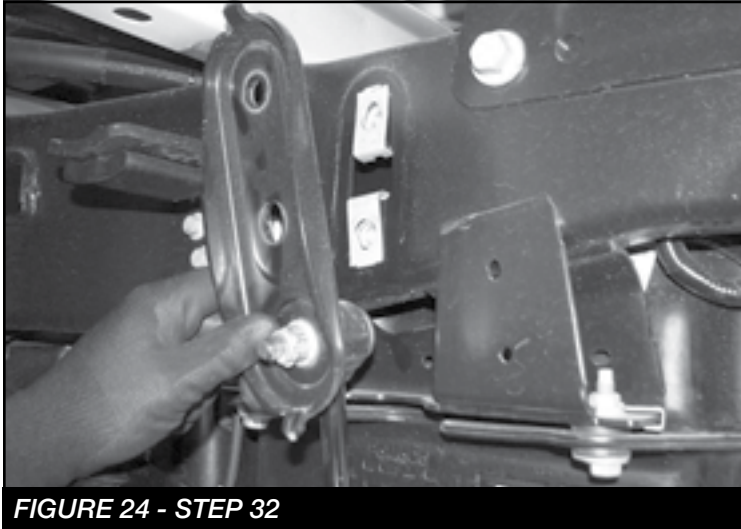

**FIGURE 24 - STEP 32**

33. Remove the factory bump stop from the frame and separate the bumpstop from the mounting plate. Install FT30750 (Bumpstop Extension) onto the bumpstop using the factory nut. **Note: The alignment tab will seat into the hole on the new bracket. SEE FIGURE 25**



**FIGURE 25 - STEP 33**

34. Using a 1/2" drill bit. Drill out the center hole on the factory bumpstop mounting plate. **SEE FIGURE 26**

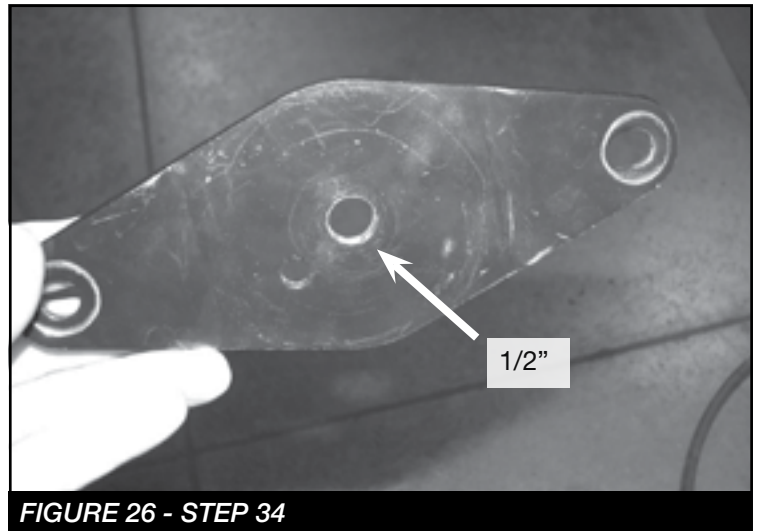

**FIGURE 26 - STEP 34**

35. Using the supplied 1/2" X 1-1/4" hardware. Install the mounting plate to the bumpstop assembly. **NOTE: Make sure the orientation is in line as shown in FIGURE 27.** Torque hardware to 127 ft-lbs.



**FIGURE 27 - STEP 35**

36. Install the bumpstop assembly into the vehicle using the factory hardware. Torque to 100 ft-lbs. **SEE FIGURE 28**



FIGURE 28 - STEP 36

37. Install the FT1004 (Bushings) and FT50089 (Sleeves) into both FT30784 (End Links). Install the new end links to the factory brackets using the supplied 1/2" X 2-1/2" hardware. **NOTE: Install the bolt from the back side. SEE FIGURE 29** Install the brackets/Tie rods to the frame and sway bar using the factory hardware for the frame mount and the supplied 1/2 X 2-1/2" hardware at the sway bar location. Torque to 127 ft-lbs. **SEE FIGURE 30**

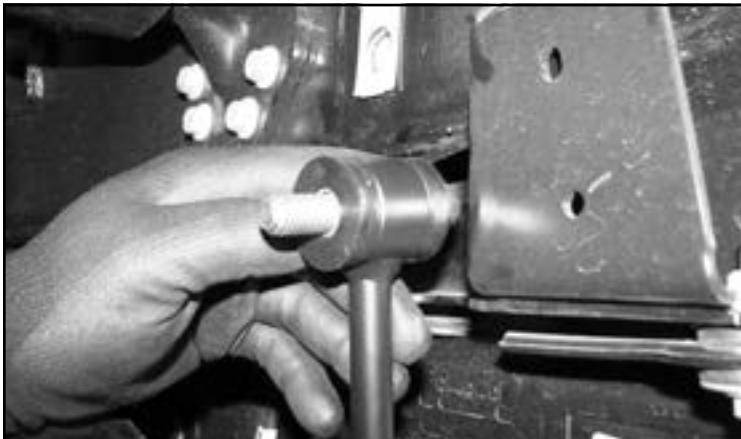

FIGURE 29 - STEP 37

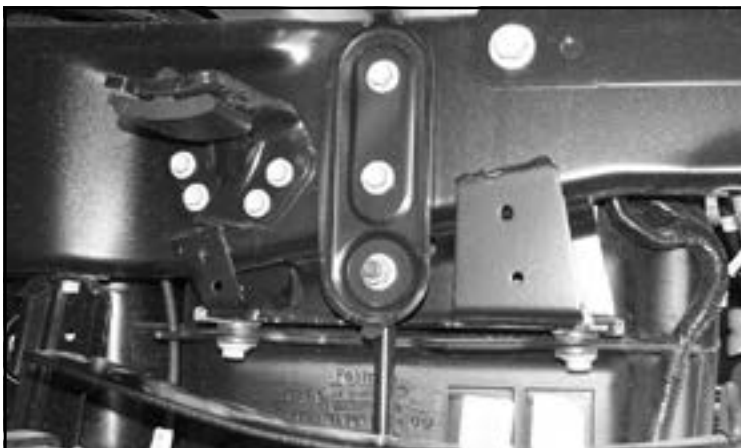

FIGURE 30 - STEP 37

38. Install the new rear shocks FTS7266, FTS6063 or DL FTS810052 using the factory hardware, torque to 90 ft-lbs. **SEE FIGURE 31-32**

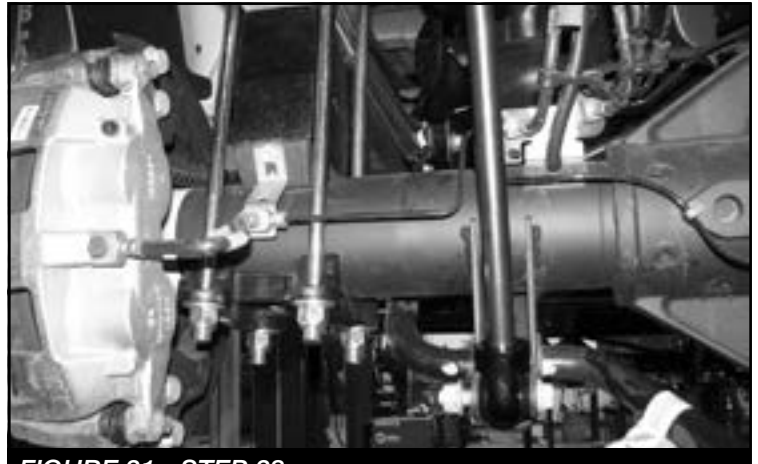

FIGURE 31 - STEP 38

39. Install tires and wheels and torque lug nuts to wheel manufacturer's specifications. Turn front tires left to right and check for appropriate tire clearance. **Note - Some oversized tires may require trimming of the front bumper & valance.**
40. Check front end alignment and set to factory specifications. Readjust headlights.
41. Recheck all bolts for proper torque.
42. Recheck brake hoses, ABS wires and suspension parts for proper tire clearance while turning tires fully left to right.
43. Check the fluid in the front and rear differential and fill if needed with factory specification differential oil. **Note - some differentials may expel fluid after filling and driving. This can be normal in resetting the fluid level with the new position of the differential/s.**
44. Install Driver Warning Decal. Complete product registration card and mail to Fabtech in order to receive future safety and technical bulletins on this suspension.

**Vehicles that will receive oversized tires should check ball joints, uniballs and all steering components every 2500-5000 miles for wear and replace as required.**

**RE-TORQUE ALL NUTS, BOLTS AND LUGS AFTER 50 MILES AND PERIODICALLY THEREAFTER.**

For technical assistance call: **909-597-7800**

1/4" Radius

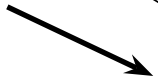

1/4" Radius

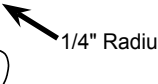

1/4" Radius

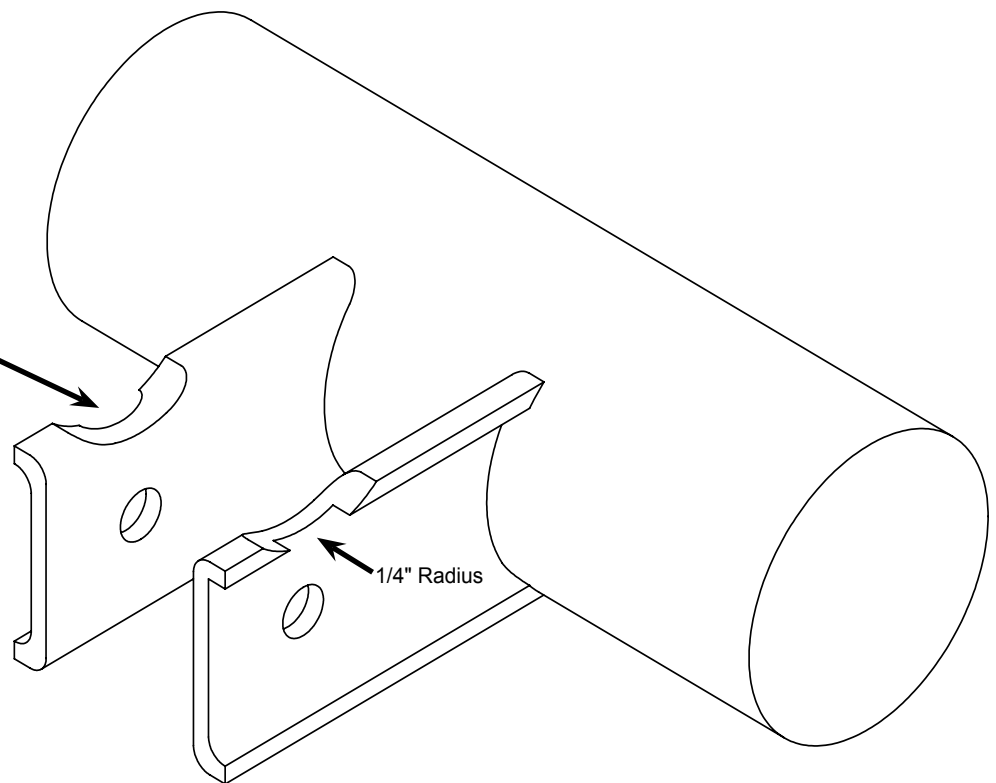
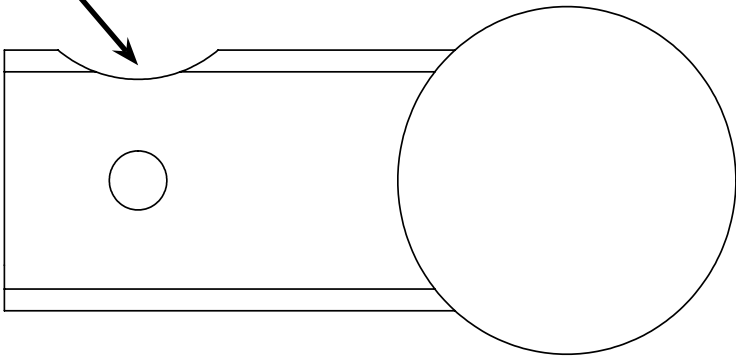



## - Product Warranty and Warnings -

Fabtech provides a Limited Lifetime Warranty to the original retail purchaser who owns the vehicle, on which the product was originally installed, for defects in workmanship and materials.

The Limited Lifetime Warranty excludes the following Fabtech items; bushings, bump stops, ball joints, tie rod ends, limiting straps, cross shafts, heim joints and driveshafts. These parts are subject to wear and are not considered defective when worn. They are warranted for 60 days from the date of purchase for defects in workmanship.

Dirt Logic and Performance Coilover take apart shocks are considered a serviceable shock with a one year warranty on leakage only. Service seal kits are available separately for future maintenance. All other shocks are covered under our Limited Lifetime Warranty.

Fabtech does not warrant any product for finish, alterations, modifications and/or installation contrary to Fabtech's instructions. Alterations to the finish of the parts including but not limited to painting, powder coating, plating and/or welding will void all warranties. Some finish damage may occur to parts during shipping, which is considered normal and is not covered under warranty.

Fabtech products are not designed nor intended to be installed on vehicles used in race applications or for racing purposes or for similar activities. (A "RACE" is defined as any contest between two or more vehicles, or any contest of one or more vehicle against the clock, whether or not such contest is for a prize). This warranty does not include coverage for police or taxi vehicles, race vehicles, or vehicles used for government or commercial purposes. Also excluded from this warranty are sales outside of the United States of America.

Installation of most suspension products will raise the center of gravity of the vehicle and will cause the vehicle to handle differently than stock. It may increase the vehicle's susceptibility to a rollover, on road and off road, at all speeds. Extreme care should be taken to operate the vehicle safely at all times to prevent rollover or loss of control resulting in serious injury or death. Fabtech front end Desert Guards may impair the deployment or operation of vehicles equipped with supplemental restraining systems/air bag systems and should not be installed if the vehicle is equipped as so.

Fabtech makes every effort to ensure suspension product compatibility with all vehicles listed on the website, but due to unknown auto manufacturer's production changes and/or inconsistencies by the auto manufacturer, Fabtech cannot be responsible for 100% compatibility, including the fitment of tire and wheel sizes listed. The Tire and Wheel sizes listed in Fabtech's website are only a guideline for street driving with noted fender trimming. Fabtech is not responsible for damages to the vehicle's body or tires. Fabtech is not responsible for premature wear of factory components due to the installation of oversized tires and wheels.

Fabtech's obligation under this warranty is limited to the repair or replacement, at Fabtech option, of the defective product only. All costs of removal, installation or re-installation, freight charges, incidental or consequential damages are expressly excluded from this warranty. Fabtech is not responsible for damages and/or warranty of other vehicle parts related or non related to the installed Fabtech product. This warranty is expressly in lieu of all other warranties expressed or implied. This warranty shall not apply to any product that has been subject to accident, negligence, alteration, abuse or misuse as determined by Fabtech.

Fabtech suspension components must be installed as a complete system including shocks as shown on our website. All warranties will become void if Fabtech parts are combined and/or substituted with other aftermarket suspension products. Combination and/or substitution of other aftermarket suspension parts may cause premature wear and/or product failure resulting in an accident causing injury or death. Fabtech does not warrant products not manufactured by Fabtech.

Depending on the condition of the factory suspension components retained after the installation of a Fabtech suspension not all vehicles may have the same ride stance front to rear as described in the website. The blue color of suspension components shown in all Fabtech photographs are for display purposes only. Majority of all Fabtech components will be black specifically where noted with part numbers ending in BK.

Installation of Fabtech product may void the vehicles factory warranty; it is the consumer's responsibility to check with their local vehicle's dealer for warranty disposition before the installation of the product. Some state laws may prohibit modification of suspension to a vehicle in whole or in part. It is the responsibility of the installer and consumer to consult local laws prior to the installation of any Fabtech suspension product to comply with such written laws.

It is the responsibility of the distributor and/or the retailer to review all warranties and warnings of Fabtech products with the consumer prior to purchase.

Fabtech reserves the right to super cede, discontinue, change the design, finish, part number and/or application of parts when deemed necessary without written notice. Fabtech is not responsible for misprints or typographical errors within the website or price sheet. For the most recent Product Warranty and Warnings visit our website [www.fabtechmotorsports.com](http://www.fabtechmotorsports.com)