

INSTALLATION INSTRUCTIONS

99-11 CHEVY SILVERADO 2500/3500 REG CAB LB / 01-11 CHEVY 2500/3500HD REG CAB LB
 99-11 GMC SIERRA 2500/3500 REG CAB LB / 01-11 GMC SIERRA 2500/3500HD REG CAB LB
PART NUMBER 364017/364017-2

PARTS LIST:

1	Passenger Side Bar	2	Rear Support Bracket 2011
1	Driver Side Bar	2	10mm x 37mm bolt tab
1	Passenger Side Front Mounting Bracket	20	10-1.50mm x 30mm Hex Head Bolts
1	Driver Side Front Mounting Bracket	10	10mm Hex Nuts
1	Passenger Side Middle Mounting Bracket	24	10mm Lock Washers
1	Driver Side Middle Mounting Bracket	30	10mm ID x 25mm OD x 1.5mm Flat Washers
1	Passenger Side Rear Mounting Bracket	2	12-1.75mm x 30mm Hex Head Bolts
1	Driver Side Rear Mounting Bracket	2	12mm Hex Nuts
2	Front Support Bracket 99-10	4	12mm ID x 29mm x 3mm Flat Washers
2	Middle Support Brackets 99-10	2	12mm Lock Washers
2	Front Support Bracket 2011	2	10mm Nut Plates
2	Middle Support Brackets 2011	2	10mm x 46mm bolt tab
2	10mm Plastic Retainers		

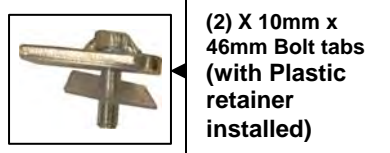
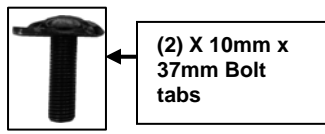
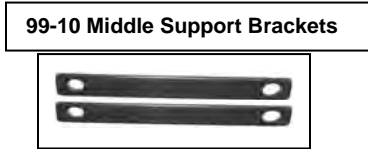
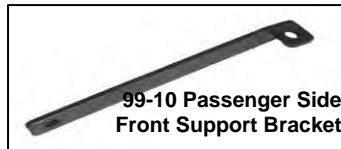

2011 Passenger Side Front Support Bracket 2500/3500 Models

2011 Passenger Side Middle Support Bracket 2500/3500 Models

2011 Driver Side Middle Support Bracket 2500/3500 Models

2011 Driver Side Front Support Bracket 2500/3500 Models

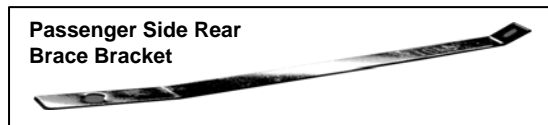

PROCEDURE:

1. **REMOVE CONTENTS FROM BOX. VERIFY ALL PARTS ARE PRESENT. READ INSTRUCTIONS CAREFULLY BEFORE STARTING INSTALLATION.**
2. From underside of vehicle remove front, and rear body mount bolts. Do not remove bushings.
3. Hang driver side front, and rear Mounting Brackets into position by partially threading factory body mounting bolts back into body mounts **(Fig 1)**.
4. Locate the two factory holes in the bottom of the frame towards the front of the vehicle. Insert (1) Nut Plate through oval hole and orient Nut Plate towards the front round hole, **(Fig 2)**.
5. Attach driver side front Support Bracket to already inserted Nut Plate by partially threading (1) 10mm x 30mm Hex Head Bolt, (1) 10mm Lock washer, and (1) 10mm Flat Washer **(Fig 3 & 4)**.

(1999-11) Front brace brackets 1500 Models:

Attach opposite side of driver side front Support Bracket to outside hole in the Mounting Bracket using the included (1) 10mm x 30mm Hex Head Bolt, (1) 10mm Hex Nut, (1) 10mm Lock Washer, and (2) 10mm Flat Washers **(Fig 3)**. Do not tighten at this time.

(1999-10) Front brace brackets 2500 Models:

Note that the Support Bracket will not reach the Mounting Bracket **(Fig 4)**. Tighten the Support Bracket to Nut Plate in the frame. Carefully push up on the Support Bracket until it reaches the inside hole in the Mounting Bracket **(Fig 5)**. Attach opposite side of driver side front Support Bracket to inside hole in the Mounting Bracket using the included (1) 10mm x 30mm Hex Head Bolt, (1) 10mm Hex Nut, (1) 10mm Lock Washer, and (2) 10mm Flat Washers **(Fig 6)**. Do not tighten at this time.

(2011) Front brace brackets 2500 Models:

Attach driver side front Support Bracket to the already inserted Nut Plate by partially threading (1) 10mm x 30mm Hex Bolt, (1) 10mm Lock washer, and (1) 10mm Flat Washer as seen in **(Fig 7)**
Attach opposite side of driver side front Support Bracket to outside hole in the Mounting Bracket using the included (1) 10mm x 30mm Hex Head Bolt, (1) 10mm Hex Nut, (1) 10mm Lock Washer, and (2) 10mm Flat Washers **(Fig 7A)**. Do not tighten at this time.

(1999-11) 1500 and (1999-10) 2500 Models Middle brace brackets

6. From the inner side of the middle body mount, place (1) Middle Support Bracket onto front side of the body mount. Attach Middle Support Bracket to body mount using the included (1) 12-1.75mm x 30mm Hex Head Bolt, (1) 12mm Hex Nut, (1) 12mm Lock Washer, and (2) 12mm Flat Washers **(Fig 8 & 9)**. Do not tighten at this time. **NOTE:** Larger hole on the Middle Support Bracket mounts to body mount.
7. Attach opposite side of Middle Support Bracket to Middle Mounting Bracket using the included (1) 10-1.50mm x 30mm Hex Head Bolts, (1) 10mm Hex Nuts, (1) 10mm Lock Washers, and (2) 10mm Flat Washers **(Fig 8 & 9)**. Do not tighten at this time.
8. **(2011) 2500 Models: Middle brace brackets**
Located just above the mount bracket there is a oblong hole as seen in **(Fig 10)** place the bolt tab in the hole, select the driver side brace bracket and secure it to the bolt tab with (1) 10mm Hex Nut, (1) 10mm Lock Washer, and (1) 10mm Flat Washers attach opposite side of driver side Middle Support Bracket to inside hole in the Mounting Bracket using the included (1) 10mm x 30mm Hex Head Bolt, (1) 10mm Hex Nut, (1) 10mm Lock Washer, and (2) 10mm Flat Washers **(Fig 10A)**. Do not tighten at this time.
9. Next, from the parts list above partially thread a Plastic Retainer onto the threaded end of the 10mm x 46mm Bolt Plate.
10. Once you have assembled the Plastic Retainer onto the Bolt Plate, insert the Bolt Plate into the factory oval hole on the frame rail. Once the Bolt Plate is inserted, hold the Bolt end with one hand and tighten the Plastic Retainer with your other hand. **NOTE:** Tighten the Plastic Retainer until it reaches the side panel, **(Fig 11)**. Shows Bolt Plate installed with plastic retainer.

11. From the parts list above, select the Driver/Left side rear mount bracket. Position the mount bracket onto the installed Bolt Plate. Secure it with (1) 10mm x 30 OD flat washers, (1) 10mm lock washers and (1) 10mm Hex Nuts, **(Fig 11A)**. Shows mount bracket installed with hardware. Snug but do not tighten hardware.
12. Located on the under side of the bed of the truck **(Fig12)** shows location of factory bolt, remove the factory bolt Select & secure the driver/left side rear brace bracket, with this bolt, fasten the rear brace bracket to the rear mounting bracket with (1) 10mm x 30mm hex bolt, (2) 10mm x 30 OD flat washers, (1) 10mm lock washers and (1) 10mm Hex Nuts, **(Fig 13)** shows brace bracket attached. Snug but do not tighten hardware at this time.
13. Carefully position Driver Side Bar onto Mounting Brackets. Attach Side Bar to Mounting Brackets using the included (6) 10-1.50mm x 30mm Hex Head Bolts, (6) 10mm Lock Washers, and (6) 10mm Flat Washers **(Fig 14)**.shows front bracket attaching to side bar, middle & rear brackets are attached the same, Do not tighten at this time.
14. Level and adjust Side Bar, then tighten all hardware at this time.
15. Repeat steps 2-13 for passenger Side Bar.
16. Do periodic inspections to the installation to make sure that all hardware is secure and tight.

To protect your investment, wax this product after installing. Regular waxing is recommended to add a protective layer over the finish. Do not use any type of polish or wax that may contain abrasives that could damage the finish.

For stainless steel: Aluminum polish may be used to polish small scratches and scuffs on the finish. Mild soap may be used also to clean the Sidebar.

For gloss black finishes: Mild soap may be used to clean the Sidebar.

Driver Side Installation Pictured

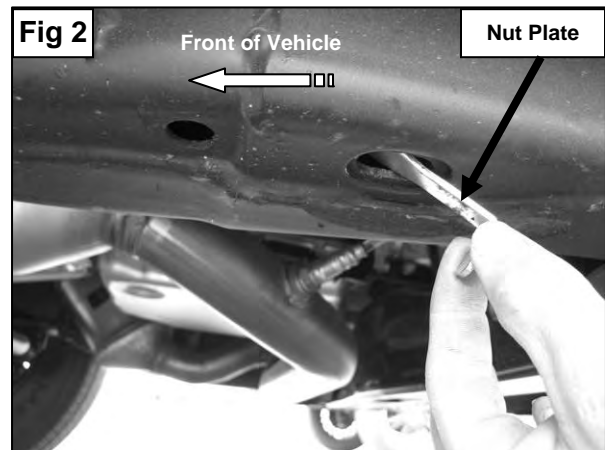
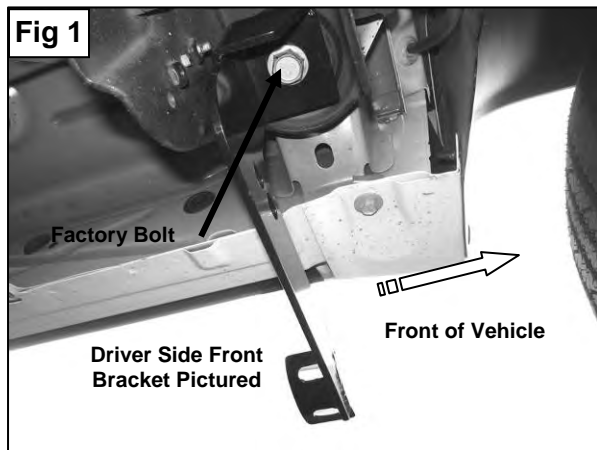

1999-11 1500 Model Front Installation Pictured

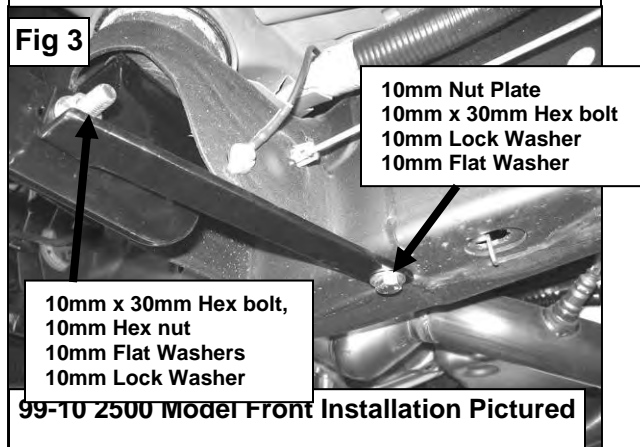

1999-10 2500 Model Front Installation Pictured

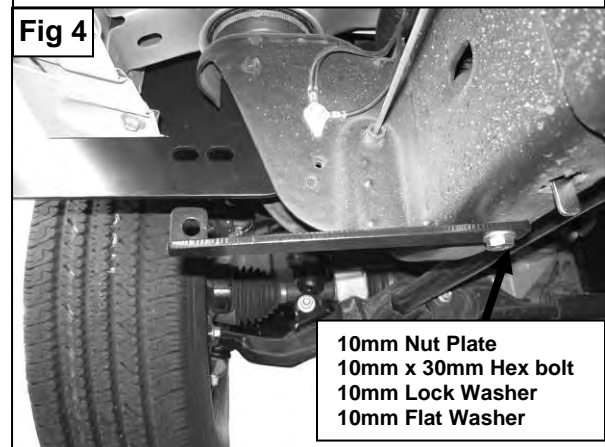
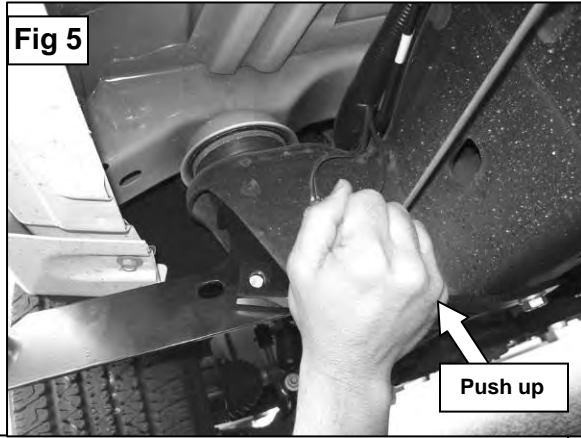

Fig 5



Push up

2011 2500 Model Front Installation Pictured

Fig 6

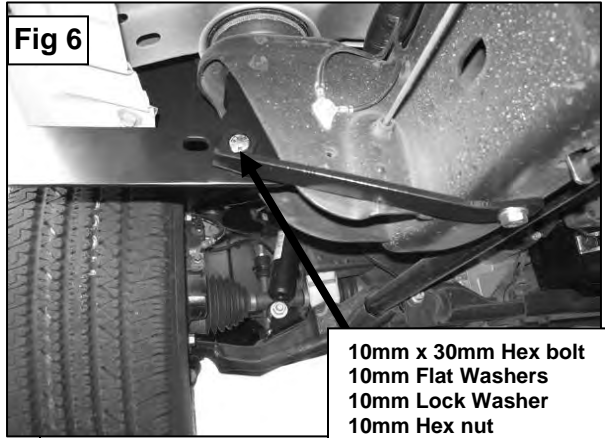

10mm x 30mm Hex bolt
10mm Flat Washers
10mm Lock Washer
10mm Hex nut

2011 2500 Model Center Installation Pictured

Fig 7

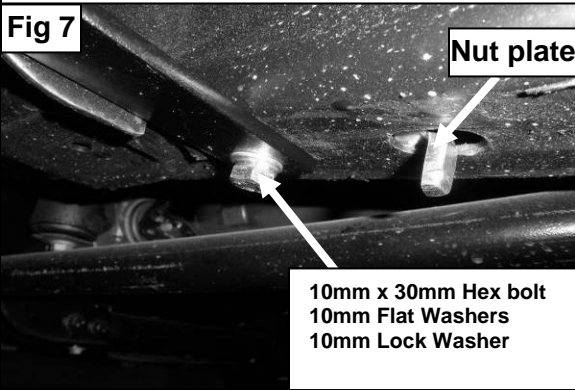

Nut plate

10mm x 30mm Hex bolt
10mm Flat Washers
10mm Lock Washer

Fig 7A

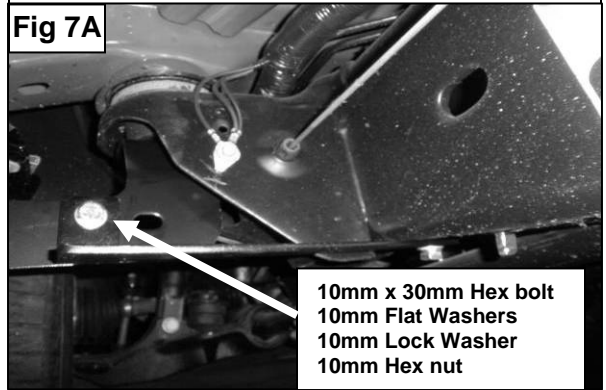

10mm x 30mm Hex bolt
10mm Flat Washers
10mm Lock Washer
10mm Hex nut

1500 Model Rear Installation Pictured

Fig 8

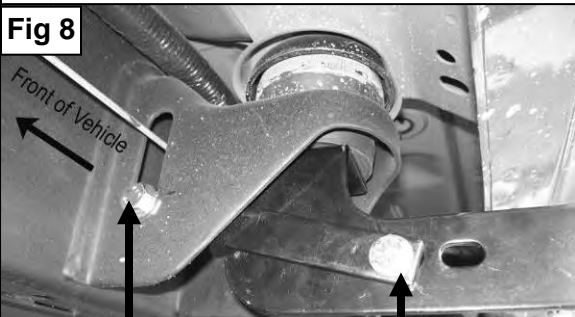

12mm x 30mm Hex bolt
12mm Hex nut
12mm Flat Washers
12mm Lock Washer

10mm x 30mm Hex bolt,
10mm Hex nut
10mm Flat Washers
10mm Lock Washer

99-10 2500 Model Rear Installation Pictured

Fig 9



12mm x 30mm Hex bolt
12mm Hex nut
12mm Flat Washers
12mm Lock Washer

10mm x 30mm Hex bolt,
10mm Hex nut
10mm Flat Washers
10mm Lock Washer

2011 2500 Model Rear Installation Pictured

Fig 10

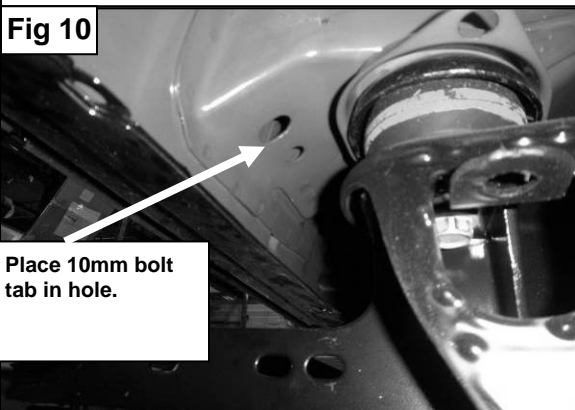

Place 10mm bolt tab in hole.

2011 2500 Model Rear Installation Pictured

Fig 10A

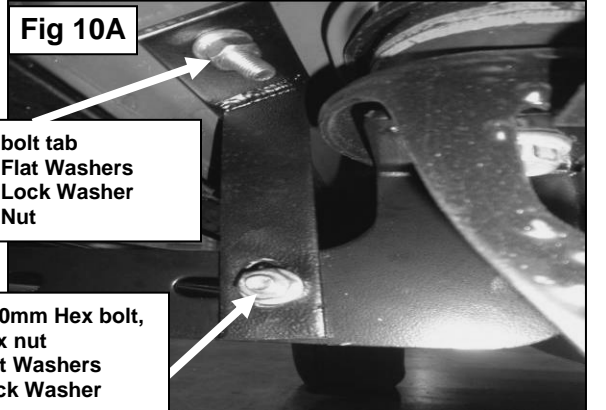

10mm bolt tab
10mm Flat Washers
10mm Lock Washer
10mm Nut

10mm x 30mm Hex bolt,
10mm Hex nut
10mm Flat Washers
10mm Lock Washer

Fig 11

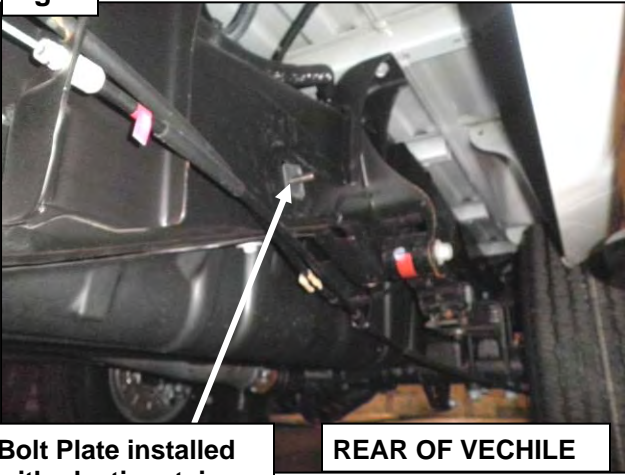

Bolt Plate installed with plastic retainer

REAR OF VECHILE

Fig 11A

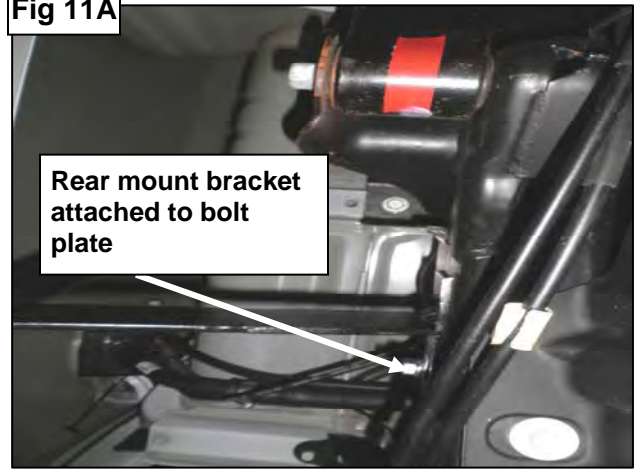

Rear mount bracket attached to bolt plate

Fig 12

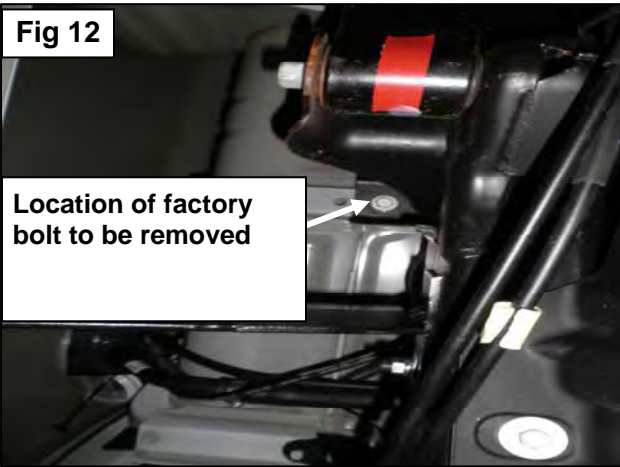

Location of factory bolt to be removed

Fig 13

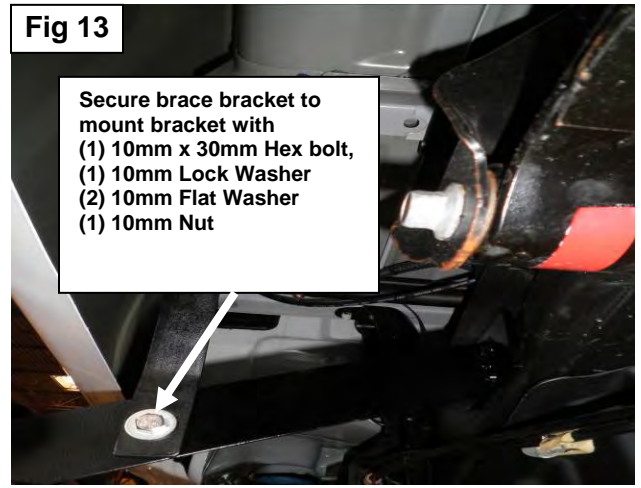

**Secure brace bracket to mount bracket with
(1) 10mm x 30mm Hex bolt,
(1) 10mm Lock Washer
(2) 10mm Flat Washer
(1) 10mm Nut**

Fig 14

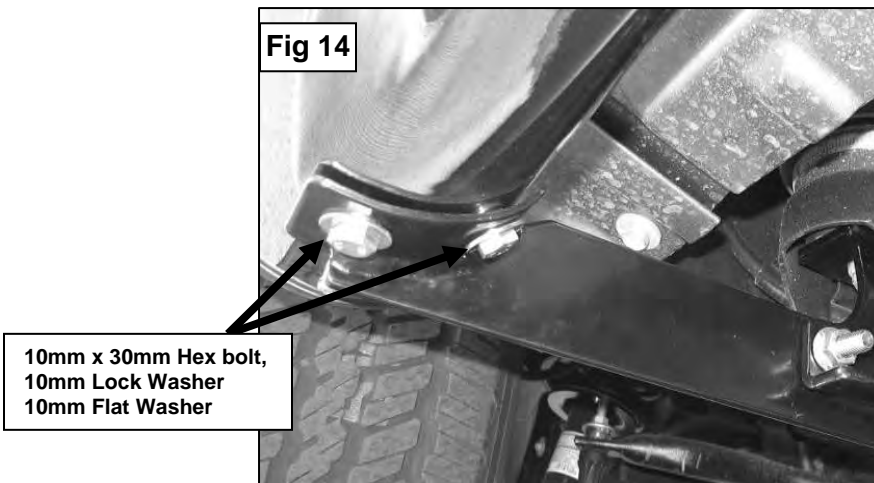

**10mm x 30mm Hex bolt,
10mm Lock Washer
10mm Flat Washer**

INSTALLTION ALERT

General Motors has made changes to their late model 2010 and 2012 Chevrolet Silverado and GMC Sierra Light Duty and Heavy Duty Trucks and these changes affect the installation of our Side Bars.

Currently, all Side Bars manufactured for GM trucks use the factory body mount bolts to attach the bars and brackets to the truck. In years past, GM used a fixed nut that was welded in place to the chassis of the truck. Starting late 2010, GM has now gone to a loose nut that is surrounded by a "Cage Nut" which has two tabs on either side of the nut to keep it from loosening. Along with this cage nut, GM is also using Heavy Duty Loc-tite on the Body Mount Bolts for added protection.

Due to this change, Aries is recommending **EXTREME CARE** when removing the factory body mount bolts from these trucks. **Loosen and re-tighten all body mount bolts by hand! DO NOT use Impact Tools of any kind!** If bolts become increasingly tight as you are loosening them you may need to retighten & loosen the bolt several times to clear the loc-tite from the threads Failure to follow this instruction could cause the body mount bolts to seize and the tabs of the 'Cage Nut' to bend allowing the nut to spin freely inside Chassis floor board!

Most of clients have been installing the existing side bar applications on these new trucks with no issues, but please be sure to follow our recommendation to prevent any installation issues. If you have any questions, please feel free to call our Customer Service Department at 888-800-2743.

