

## advanced FLOW engineering

**Instruction Manual** P/N: 51/52-13002-B / 54-13002-B / 75-13002-B /  
51-13002-H / 54-13002-H / 75-13002-H

Make: **Jeep**  
Make: **Jeep**

Model: **Wrangler (JL)**  
Model: **Gladiator (JT)**

Year: **2018-2019**  
Year: **2020**

Engine: **V6-3.6L**  
Engine: **V6-3.6L**



- Please read the entire instruction manual before proceeding.
- Ensure all components listed are present.
- If you are missing any of the components, call customer support at 951-493-7100.
- Ensure you have all necessary tools before proceeding.
- Do not attempt to work on your vehicle when the engine is hot.
- Disconnect the negative battery terminal before proceeding.
- Retain factory parts for future use.

Label	Qty.	Description	Part Number
A1	1	Air Filter (Pro 5R)	24-91127
A2	1	Air Filter (Pro DRY S)	21-91127
A3	1	Air Filter (Pro-GUARD 7)	72-91127
B1	1	Tube	05-13002B1
B2	1	Tube	05-13002H1
C	1	Housing	05-13002B2
D	1	Coupling, Silicone Reducer	05-00636
E	1	Coupling, Silicone Reducer Bellows	05-01400
F	1	Seal Trim: 7/16" Bulb (21-1/2" inches)	05-00072
G	4	Clamp, #048	03-50007
H	1	Adaptor	05-01037
I	3	Screw, Btn Hd Socket: M6 x 1 x 10	03-50113

Installation will require the following tools:  
8mm/10mm nut drivers and 4mm Allen wrench.

Note: Legal in California for use on race vehicles only. The use of this device on vehicles used on public streets or highways is strictly prohibited in California and others states that have adopted California emission regulations.

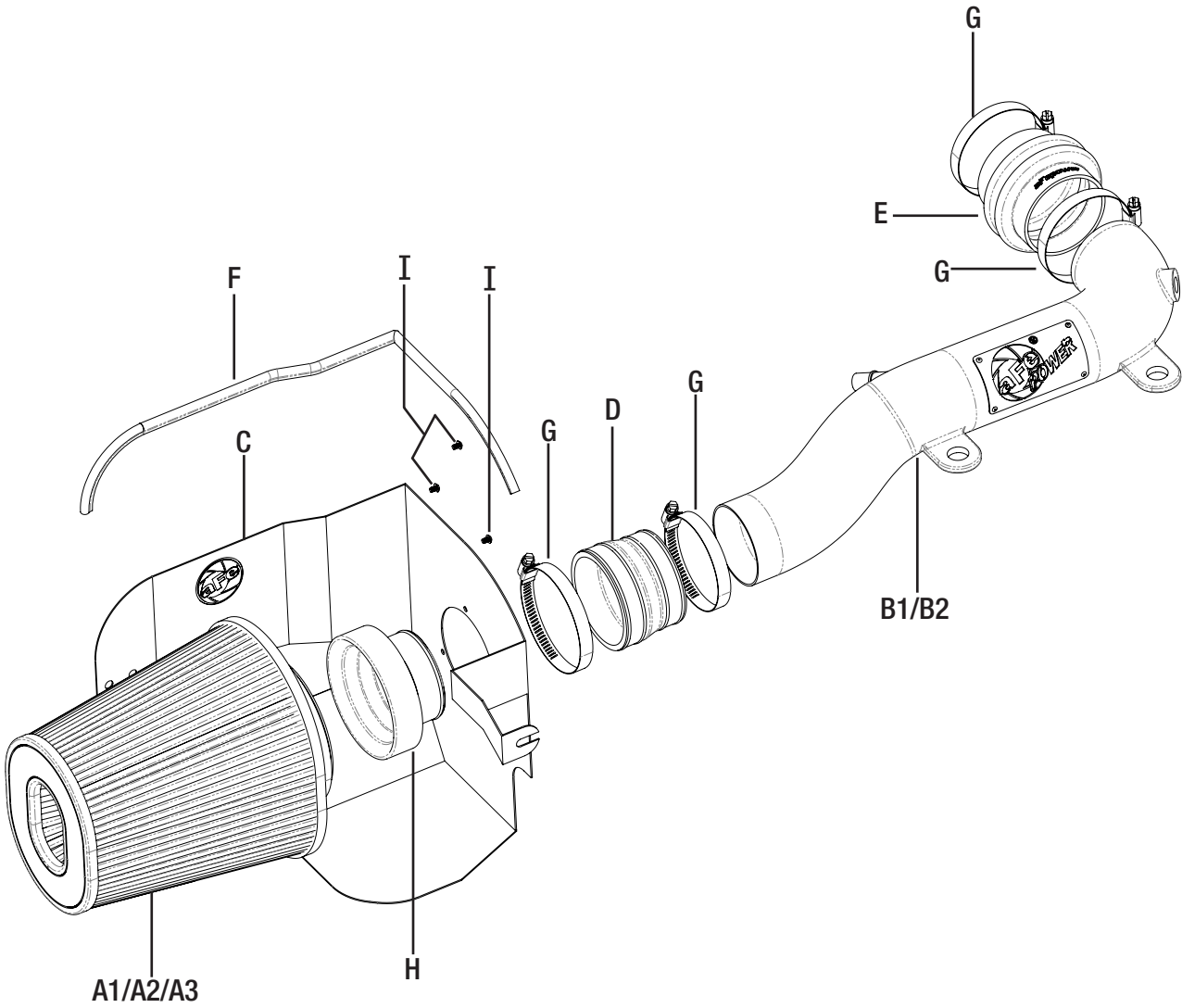



**Refer to Figure A for Steps 1-2**

- Step 1: Disconnect the intake tube sensor and the quick connect vent hose and gently disconnect wire harness from intake chamber.
- Step 2: Loosen the throttle body clamp.

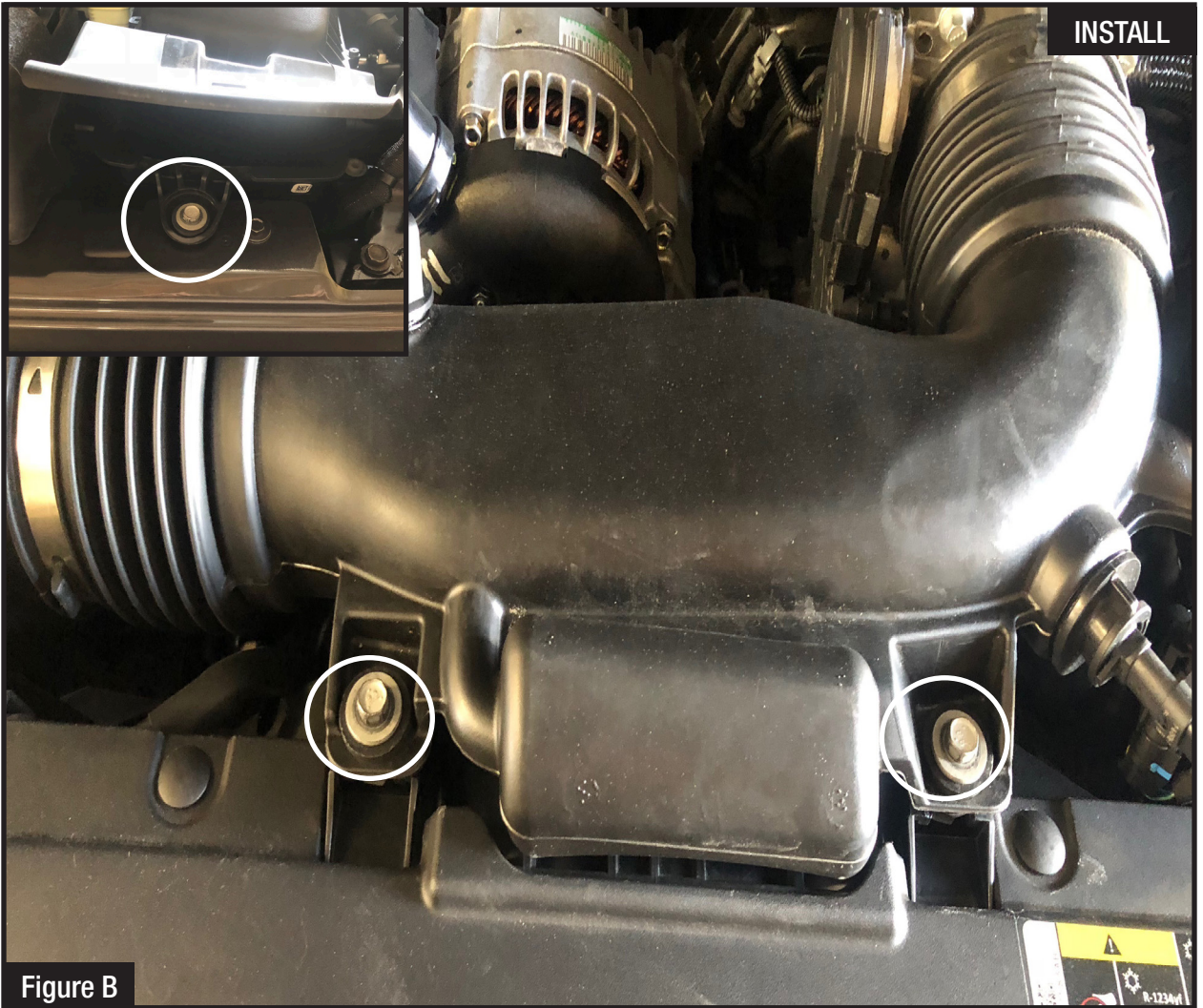

Figure B

**Refer to Figure B for Step 3**

Step 3: Remove the two bolts on the intake tube and one bolt on the air filter housing.



**Refer to Figure C for Step 4**

Step 4: Remove the OE tube and housing from the vehicle.

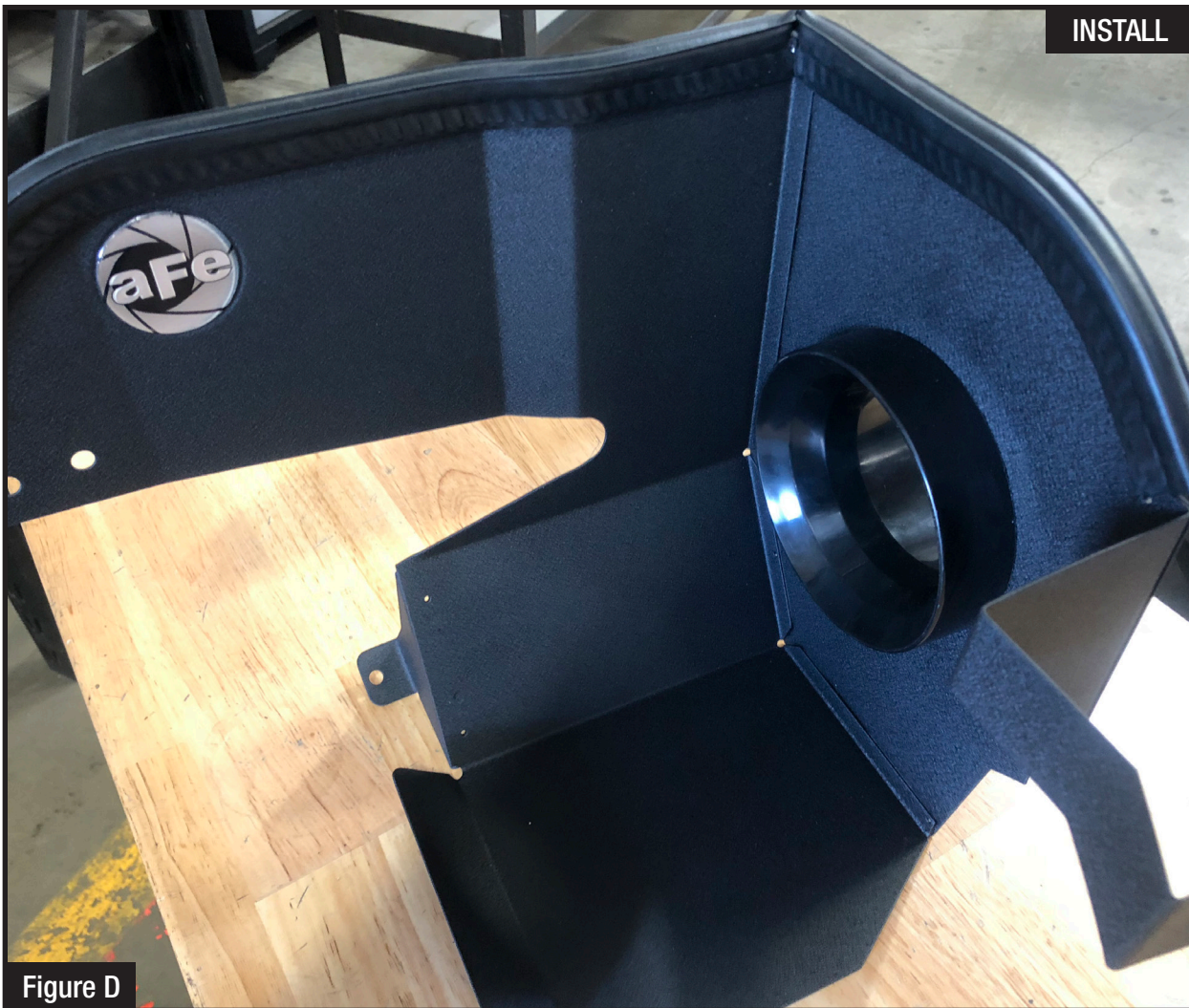
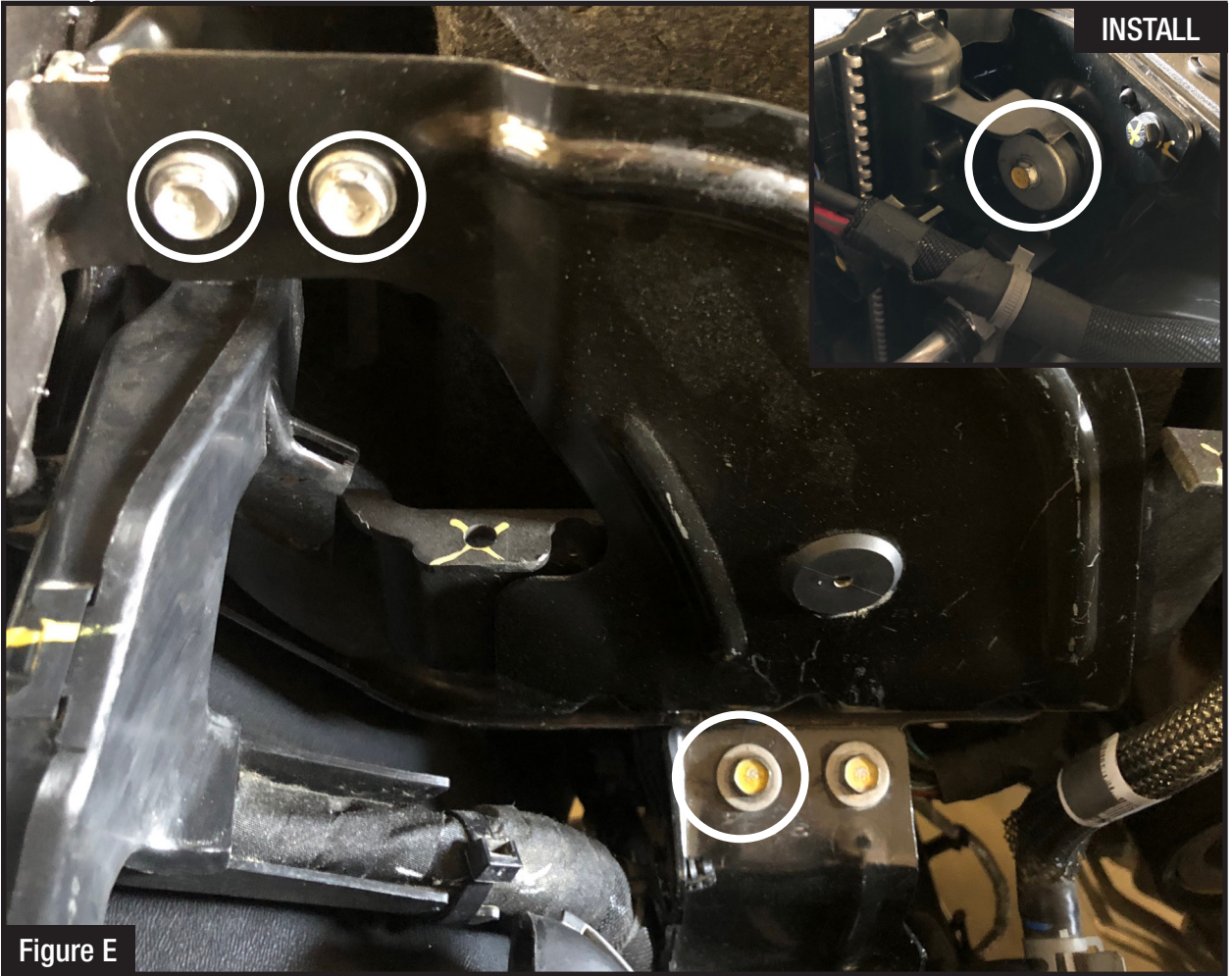

Figure D

**Refer to Figure D for Steps 5-6**

Step 5: Install trim seal onto aFe housing.

Step 6: Install filter adapter onto the housing using the three screws.



**Refer to Figure E for Steps 7-8**

- Step 7: Remove the three bolts in the filter housing area.
- Step 8: Loosen radiator mount bolt.





Figure F

**Refer to Figure F for Steps 9-10**

Step 9: Remove grommet inner sleeve and push grommet out of from OE intake tube and install into the aFe intake tube. Note the direction of the grommet sleeve. Reinstall grommet sleeve.

Step 10: Carefully remove the sensor from the OE intake tube and install it into the aFe tube.

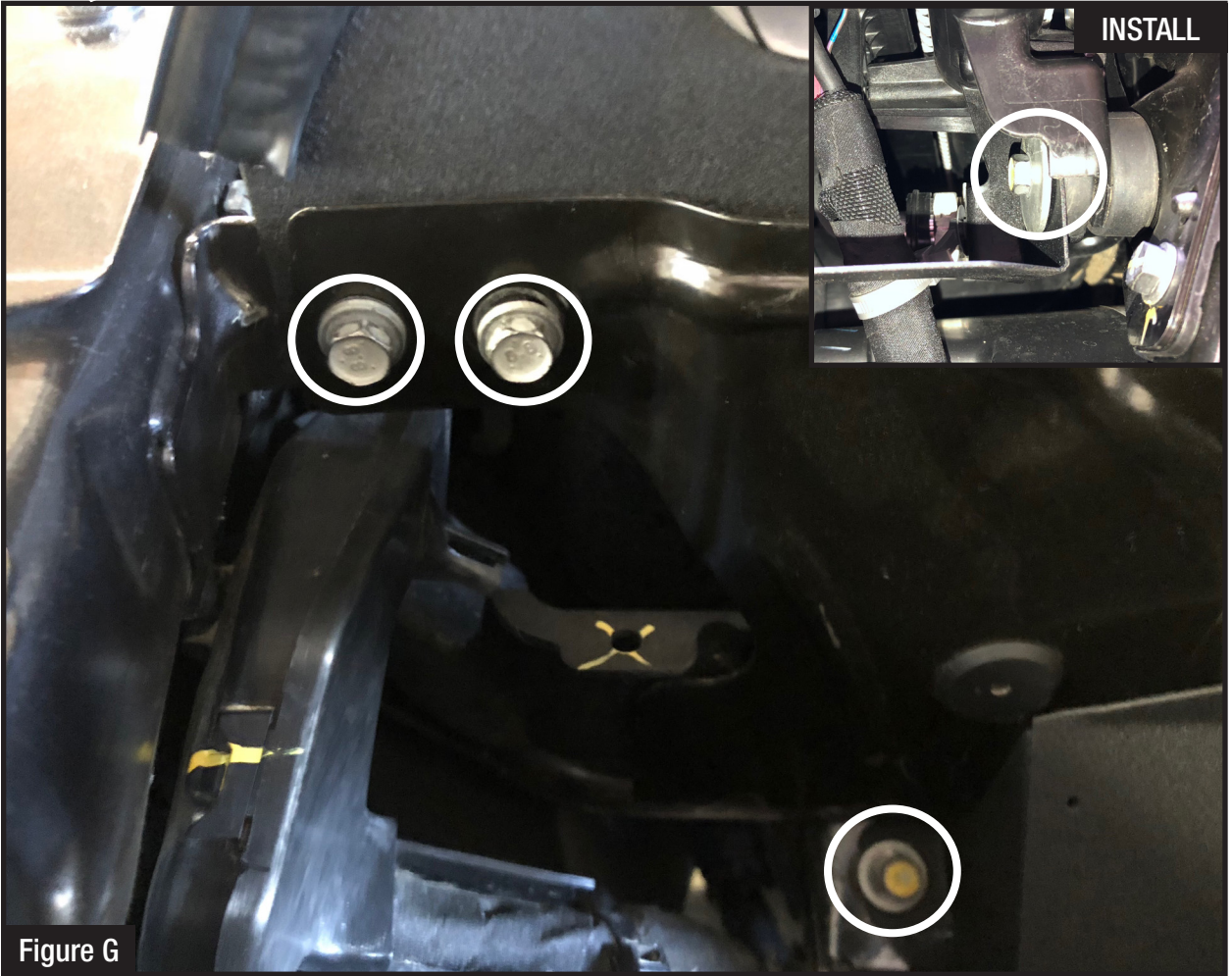

Figure G

**Refer to Figure G for Steps 11-13**

- Step 11: Install the aFe housing by lining up the mounting holes. The upper two mounting holes are sandwiched in between the top two brackets near the battery.
- Step 12: Install the slotted bracket in between the radiator bolt washer and rubber mount.
- Step 13: Reinstall the three bolts back into the engine compartment and tighten radiator mount bolt.



Figure H

### **Refer to Figure H for Steps 12-15**

Step 12: Install couplers and hose clamps onto the throttle body and filter adapter. Do not tighten hose clamps at this time.

Step 13: Install the aFe intake tube into the couplers and attach with the original mounting bolts.

Step 14: Tighten all clamps.

Step 15: Reattach the quick connect vent hose and plug in the intake tube sensor.



Figure I

**Refer to Figure I for Step 16**

Step 16: Reinstall the remaining unused bolt back into its original location.



Figure J

**Refer to Figure J for Step 17**

Step 12: Install the air filter onto the aFe intake system and tighten clamp. Your installation is now complete.

**NOTE: Check all bolts, clamps, and connectors after 100-200 miles.**



Pro DRY S Air Filter

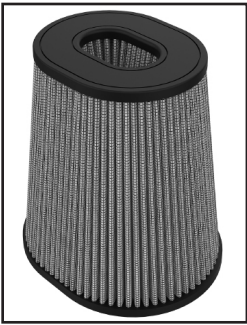

P/N: 21-91127

Pro 5R Air Filter



P/N: 24-91127

Pro-GUARD 7 Air Filter



P/N: 72-91127

Pre-Filter



P/N: 28-10303

Pro DRY S Restore Kit



P/N: 90-59999

Blue Squeeze Restore Kit



P/N: 90-50501

Gold Squeeze Restore Kit



P/N: 90-50500

Throttle Body Spacer



P/N: 46-35008

Loop Relocation



P/N: 48-48024

Exhaust Cat-Back System



P/N: 49-48066-P (Pol. Tips)  
49-48066-B (Blk. Tips)

Rear Differential Cover



P/N: 46-71000B (Black)  
46-71000A (RAW)

RaceRunner 2" Shocks



P/N: 37-D7001R (Rears)  
37-D7001F (Fronts)

To purchase any of the items above, view airflow charts, dyno graphs, photos, and video; please go to [aFepower.com](http://aFepower.com).

# Warranty

## General Terms:

- aFe warrants their products to be free from manufacturer's defects due to workmanship and material.
- This warranty applies only to the original purchaser of the product and is nontransferable.
- Proof of purchase of the aFe product is required for all warranty claims.
- Warranty is valid provided aFe instructions for installation and/or cleaning were properly followed.
- Proper maintenance with regular inspections of product is required to insure warranty coverage.
- Damage due to improper installation, abuse, unauthorized repair or alteration is not warranted.
- Incidental or consequential damages or cost, including installation and removal of part, incurred due to failure of aFe product is not covered under this warranty.
- All warranty is limited to the repair and/or replacement of the aFe part. To request Return Goods Authorization ("RGA"), email [RGA@afepower.com](mailto:RGA@afepower.com) or call (951)493-7100. Upon receipt of the RGA, you must return the product to the address provided in the RGA, freight prepaid and accompanied with a dated proof of purchase and the RGA. Upon receipt of the defective product and upon verification of proof of purchase, aFe will either repair or replace the defective product within a reasonable time, not to exceed thirty days.

<b>Product Category</b>	<b>P/N Prefix</b>	<b>Warranty duration</b>
Direct OE Replacement Filters	10, 11, 30, 31, 71, 73	Life of the vehicle
Racing Filters	18	1 year
Universal	21, 24, 72	2 years
Air Intake Systems	50, 51, 54, 55, 75	2 years
Exhaust Systems	49	2 years
Intercoolers & Intercooler Tubes	46-2	2 years
Intake Manifolds	46-1	2 years
Differential Cover	46-7	Life of the vehicle
Exhaust Manifolds	46	2 years
Throttle Body Spacers	46-3	2 years
Fluid Filters	44	90 days
Pre-Filters	28	2 years
Heavy Duty OE Replacement	70	2 years
PowerSports OE Replacement	81, 87	2 years
PowerSports Intake Systems	85	2 years

No other warranty expressed or implied applies nor is any person or advanced FLOW engineering authorized to assume any other warranty. Some States do not allow the exclusion or limitation of incidental or consequential damages or do not allow limitations on how long an implied warranty lasts, so the above limitations or exclusions may not apply to you. This warranty gives you specific legal rights, and you may also have other rights which vary from State to State.

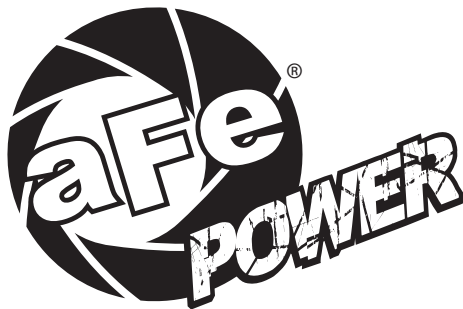

**advanced FLOW engineering, inc.**  
252 Granite Street Corona, CA 92879  
TEL: 951.493.7100 • TECH: 951.493.7154  
E-Mail: [Tech@aFepower.com](mailto:Tech@aFepower.com)