



YOSHIMURA

RESEARCH&DEVELOPMENT OF AMERICA, INC.

5420 DANIELS STREET STE A, CHINO CA., 91786 · (800)634-9166 · (909)628-4722 · FACSIMILE (909)591-2198

www.yoshimura-rd.com

RS-3 OVAL PERFORMANCE EXHAUST SYSTEM

SUZUKI
'99-06
GSX1300R

R146RRD	STAINLESS STEEL DUPLEX RACE ONLY SYSTEM
R147RRD	TITANIUM DUPLEX RACE ONLY SYSTEM

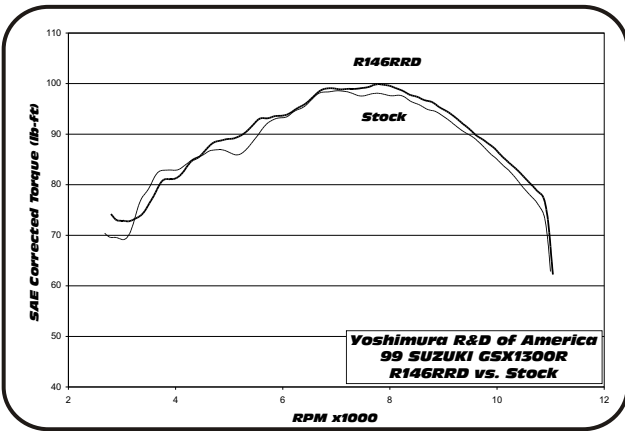
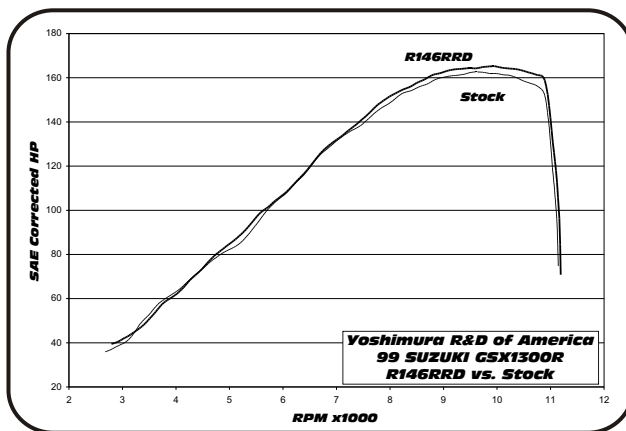

Note: Dyno graphs are for comparison use only. Actual results may vary depending on operating and motorcycle condition.



THIS PRODUCT IS DESIGNED FOR USE IN CLOSED COURSE RACING AND IS NOT INTENDED FOR HIGHWAY USE.



NOTE: IN THE STATE OF CALIFORNIA, IT IS ILLEGAL TO MODIFY THE EMISSION CONTROL SYSTEM, WHICH INCLUDES THE FUEL INJECTION OF ANY VEHICLE.

Caution: Exhaust system can be extremely hot. Let motorcycle cool down before beginning installation.

Note: Read through all instructions before beginning installation.

Tools Needed:

10mm and 12mm sockets 4mm Allen wrench
3/8" ratchet and extension 6mm Allen bit for torque wrench
12mm wrench Torque wrench

Installation Steps:

- 1 Remove lower, right and left cowlings.
(See Fig. 1, 2 and 3 for fastener locations)
- 2 Remove plastic air dam in front of oil cooler.
- 3 Unbolt oil cooler, unbolt and remove lower oil cooler bracket. (See Fig. 4) Do not disconnect oil lines from oil cooler.
- 4 Remove lower radiator mount bolt and tilt radiator forward.
(See Fig. 5.) NOTE: use of a bungee cord to keep radiator forward will ease installation.
- 5 It is recommended to cover back of oil cooler with duct tape to prevent damage during installation.

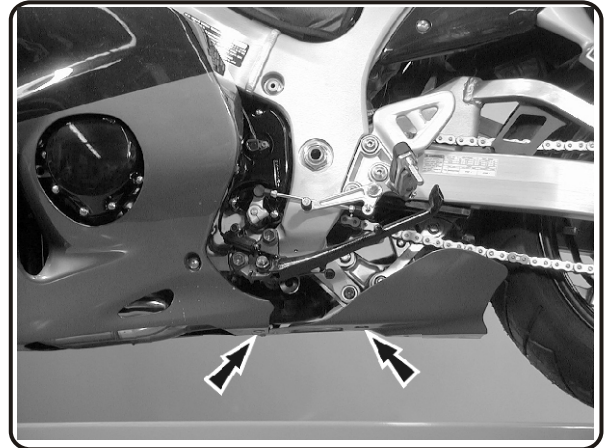

Fig. 1

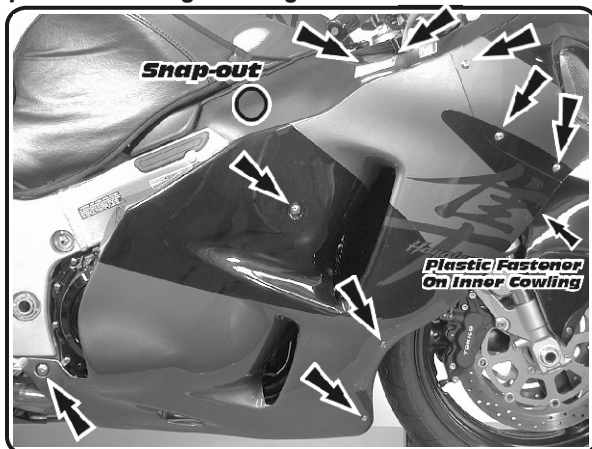

Fig. 2

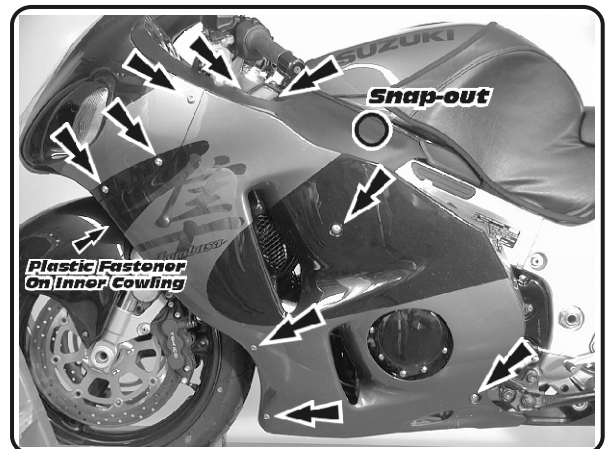

Fig. 3

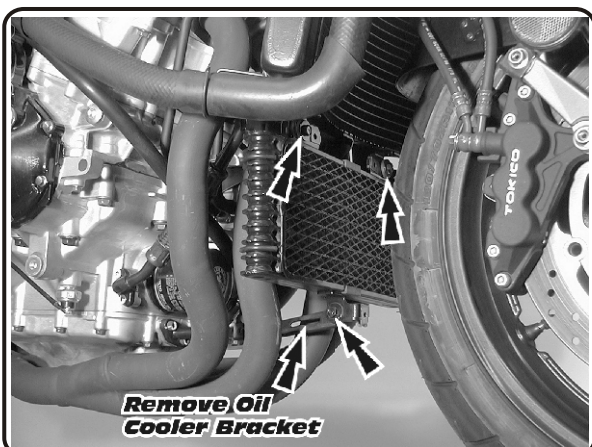

Fig. 4

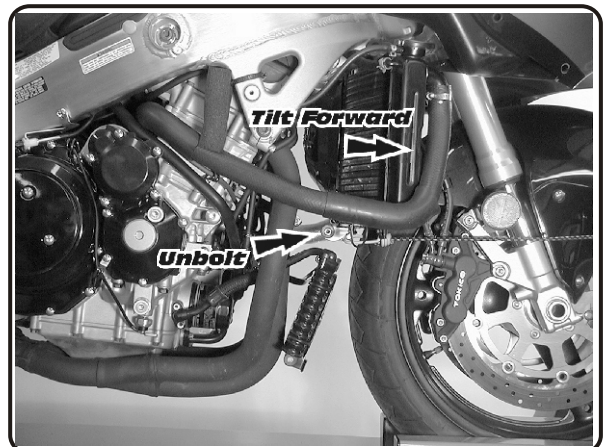

Fig. 5

- 6 Remove stock mufflers and stock exhaust system.
(Note chassis mount location in Fig. 6)
- 7 Remove exhaust port gaskets and install new exhaust port gaskets.
(not supplied - Suzuki part no. 14181-22D01)
- 8 Install Yoshimura exhaust manifolds and flanges using stock header bolts (note flange orientation in Fig. 7). Leave bolts loose to ease header installation.
- 9 Install Yoshimura header.
(Install header from one side of the engine to the other. Slip one tube at a time into manifold.)
- 10 Install 2.5" exhaust springs on header.
(Refer to Fig.7 for spring locations.)
Note: Hook one end of the spring through drilled hole on exhaust flange and pull the other end with spring puller tool onto header's spring hook.
- 11 With a soft face mallet, tap on header to fully seat tubes onto manifolds.
- 12 Bolt header to chassis mount using stock bolt, with supplied washer and nut. Do not torque at this time.
- 13 Torque header bolts to .8 kg-m (6 lb-ft).
- 14 Torque header chassis mount bolt to 2.5 kg-m (18 lb-ft).
- 15 Install Yoshimura tailpipe with muffler onto header. Install 3.5" exhaust springs between header and tailpipe.
- 16 Apply heat insulator to inside of muffler clamp and slide clamp onto muffler.
(Note direction of clamp in Fig.8)

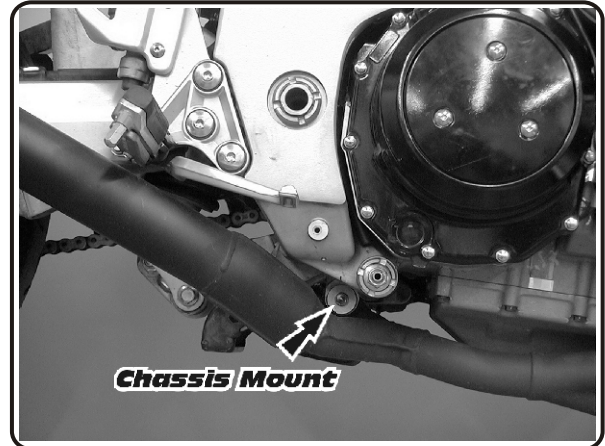

Fig. 6

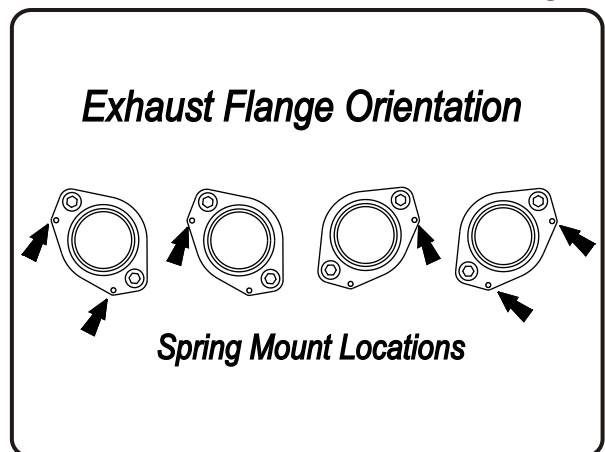
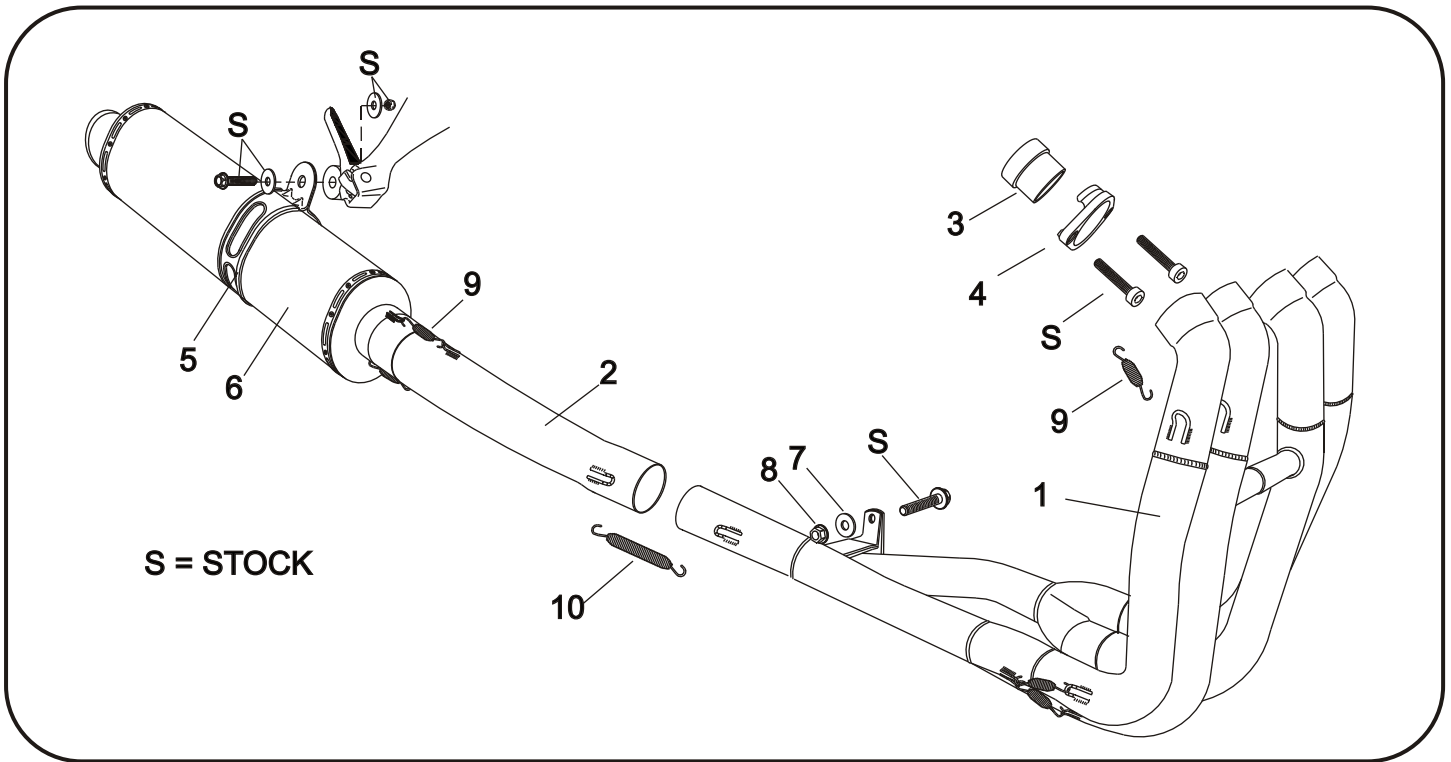

Fig. 7

- 17 Mount clamp to stock muffler bracket using stock bolt, washers and nut. (See Fig. 8)
Torque bolt to 2.5 kg-m (18 lb-ft).
- 18 It is recommended that the entire exhaust system be wiped down with rubbing alcohol to remove oil and fingerprints. This will help prevent tarnishing of the finish after the exhaust is heated up.
- 19 Reinstall radiator and oil cooler.
- 20 Check for proper clearance between new exhaust system and motorcycle. (i.e. radiator, oil pan, swing-arm, etc.) If any problem is found, please carefully follow through the installation steps again. If problem still persists, please call Yoshimura tech. dept. at (800)634-9166 / in CA (909)628-4722
- 21 Reinstall cowlings and check for proper clearance between new exhaust system and cowling.

Note: After starting motorcycle, it is normal for new exhaust system to smoke until oil residue burns off.

#R146RRD/R147RRD



Parts Diagram

NO.	DESCRIPTION	QTY	PART #
1	Yoshimura Header Stainless Steel Duplex Race Only Titanium Duplex Race Only	1	R146RRHD R147RRHD
2	Yoshimura Tailpipe Stainless Steel Race Only Titanium Race Only	1	R146RT R147RT
3	Stainless Steel Exhaust Manifold	4	R146SDM
4	Stainless Steel Exhaust Flange	4	CB916SDR-01
5	Stainless Steel Muffler Clamp Stainless Steel or Titanium Sleeve uses Carbon Fiber Sleeve uses	1	COS450S8ASX COS450S8AS

NO.	DESCRIPTION	QTY	PART #
6	20" RS-3 Oval Muffler Assembly	1	**
7	8mm Flat Washer, Large	1	8MMWASHERL
8	8mm Flange Nut	1	8MMNUT
9	2.5" Exhaust Spring	12	RACE-SPS-1
10	3.5" Exhaust Spring	2	RACE-SPL-1
**	Muffler Clamp Heat Insulator	1	HT-SHLDTRS
**	Spring Puller Tool	1	ST-200
**	Yoshimura Duplex Sticker	2	DLABEL
**	Yoshimura Sticker	2	17028-BLK

Nuts and Bolts Guide (Actual Size):

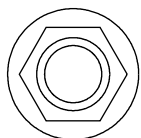

8mm Flange Nut

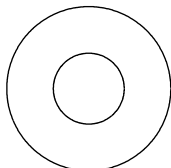

8mm Large Flat Washer

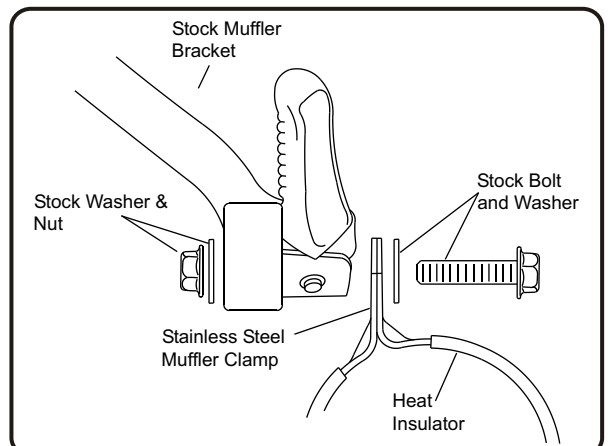

Fig. 8