

Water/Methanol Injection

**Boost
Cooler™**

**INSTALLATION INSTRUCTIONS
FOR PART #20013GN
WATER/METHANOL INJECTION
SYSTEM FOR '86 - 91
BUICK GRAND NATIONAL**



SNOW PERFORMANCE
COOLER, LIGHTER, FASTER™

CONTENTS

Kit Contents.....	3
Introduction.....	4
Installation – Mechanical.....	5
Installation - Electrical.....	10
Variable Controller Installation.....	10
Setting MAF Sensor Type.....	11
Variable Controller Tuning.....	11
Controller Operation Example.....	12
Testing the System.....	13
Tuning Quick Reference.....	14
Fluid Level Switch (optional).....	16
Solenoid Upgrade (optional).....	17
Install Notes.....	18

CAUTION  You must completely read through these instructions before installing and operating this product. Failure to do so can result in damage to this product and the vehicle.

Kit Contents

Parts

1 150+ psi Pump
2 qt Reservoir
8 ft Red High Pressure Tubing
4 ft Black Wire Loom
Installation Instructions

Electrical Packet

In small bag:

1 Green LED
2 Blue Butt Connectors
3 Small Eyehook
1 Wire splice
1 Male Connectors
3 Female Connector

VC-MAF Controller With Harness
10 Tie Wraps

Mechanical Packet

In small bag:

1 Nozzle Holder
2 3/8" NPT – 1/8" NPT Reducer Bushings
2 1/8" NPT – 1/4" Tube Elbow Fittings
7 #8x1&1/2" Screws
7 #8 Washers
1 #6x1/2" Screw

2 Stickers
2 Nozzles
1 E-6000 (GOOP)

Required Tools

Electric Drill w/ Drill Bits
Utility Knife
Screwdriver – Phillips
Assorted Wrenches

Introduction

- Please refer to the System Diagram below during install. The optional fluid level switch (#40030) is shown.

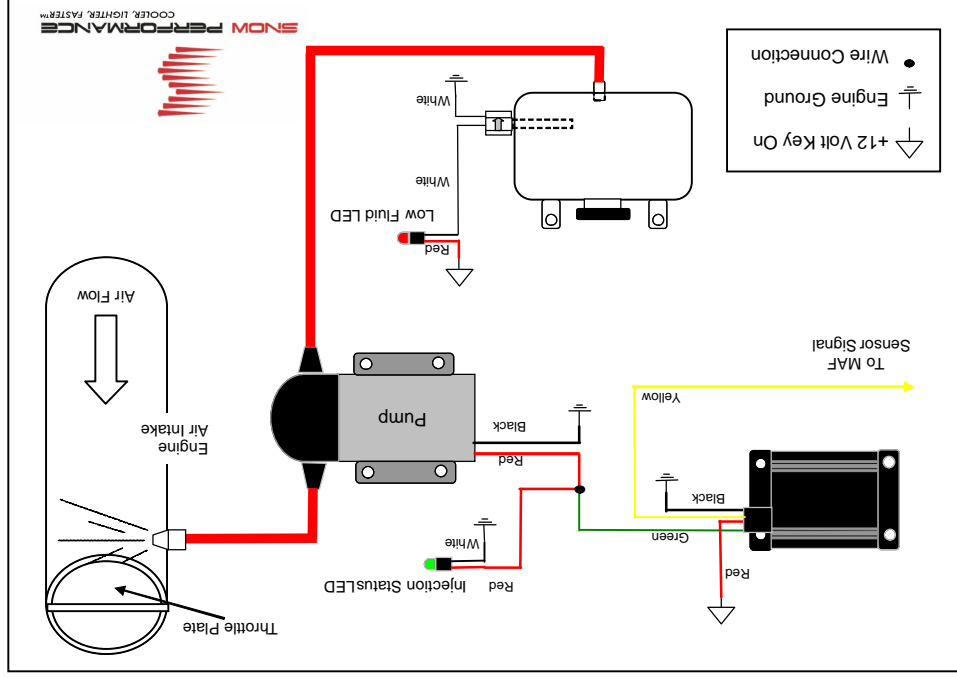

Nozzle Identification Chart:

Nozzle Color	Nozzle Size	Nozzle Color	Nozzle Size
Green	175 ml/min	Blue	625 ml/min
Black	100 ml/min	Red	375 ml/min
Yellow	60 ml/min	Purple	225 ml/min

Notes
 The contents of this document are subject to change without prior notice. No part of or this entire document may be reproduced in any form without prior written permission of Snow Performance, Inc under the copyright except for private use.

The names, addresses and telephone numbers mentioned are current as of August 31, 2007. Note that this information is subject to change. Please refer to www.snowperformance.net for current information.

Contact Us:

Phone (719) 633-3811
Office (719) 633-3496
Fax (866) 365-2762
Tech Support Line (Toll Free)

Web <http://www.snowperformance.net>

Email sales@snowperformance.net
customerservice@snowperformance.net
tech@snowperformance.net

Mail
 Snow Performance, Inc
 213 Aspen Garden Way
 Bldg. #1
 Woodland Park, CO 80863

LIFETIME WARRANTY

Snow Performance's commitment to providing the best water/methanol system is reflected in the Lifetime Warranty that is standard on all Snow Performance Boost Coolers™. We are able to offer this warranty due to our control of manufacturing quality and the historically high reliability of our products in the field.

Warranty Policy

Snow Performance, Inc. (hereafter "Snow") warrants that the Product shall conform to and perform in accordance with published technical specifications and shall be free of defects in materials and workmanship as long as :

The exclusive fluid used in the kit has been Snow performance's Boost Juice™ water methanol product as evidenced by sales receipts confirming purchases.

In the event that Boost Juice has not exclusively been used, A One Year Warranty applies.

In the event of failure, Snow will repair or replace the part at Snow's sole discretion. Failures resulting from misapplication or misuse of the Product, failure to adhere to any specifications or instructions, or failure resulting from neglect, abuse, accidents, or acts of nature are not covered under this warranty.

Warranty service may be obtained by delivering the part to Snow and providing proof of purchase. Customer agrees to insure the Product or assume the risk of loss or damage in transit, to prepay shipping charges to Snow, and to use the original shipping container or equivalent. Warranty is valid only for original purchaser and is not transferable. This Warranty gives you specific legal rights, and you may also have other rights which may vary from state to state.

This warranty applies to Snow manufactured Boost Cooler™ kits.

Non-Warranty Repair/Retest

Products returned due to damage or misuse and Products retested with no problem found are subject to repair/retest charges. A purchase order or credit card number and authorization must be provided in order to obtain an RMA (Return Merchandise Authorization) number prior to returning Product.

Installation – Mechanical

Step 1 Reservoir Install

Mount reservoir as high in engine compartment as possible using #8x1½" sheet metal screws and washers provided.

Optional: The factory windshield washer reservoir can be used as the reservoir for your system.



Tank Mounted Behind Battery

- Drill 9/16" hole in desired bulkhead location.
- Remove one nut from and turn the remaining nut until it is at the very end of the bulkhead.
- Feed red tubing through the drilled hole and up and out of the top of the reservoir.
- Attach red tubing to the bulkhead on the side opposite the nut.
- Pull the tube through the bulkhead hole until the bulkhead seats against the inside of the reservoir.
- Apply liberal amount of methanol resistant sealant around bulkhead.
- Slide the nut you had previously removed up onto the tube and thread it onto the bulkhead.
- While pulling firmly on the red tubing, tighten the outer nut using a 17mm socket (only needs to be hand tight).
- Once sealant has set, fill reservoir with water and check for leaks.

TECH TIP You can mount the tank in the rear of the vehicle. The pump is a pusher type by design so it needs to be mounted as close to the reservoir as possible. Because the pump is oversized, injection pressure will not be affected. A Solenoid Upgrade is recommended for rear mounted reservoirs.

Step 2 Pump Install

Install 3/8" to 1/8" reducer bushing using GOOP sealant on threads. Tighten 2-3 turns past hand tight. Install 1/8" elbow fitting into bushing using GOOP sealant on threads. Tighten 2-3 turns past hand tight. Mount pump so the pump inlet is positioned at the lowest point of the reservoir or lower. Pump can be mounted horizontally or vertically using (4) supplied #8x1 1/2" screws and washers.

Measure the distance from the reservoir outlet to the pump inlet. Cut the 1/4" red tubing using utility knife. Make cuts are as square as possible.



Ensure there are no kinks in the tubing and insert tubing into quick disconnects at pump and reservoir until fully seated.

Disclaimer

Do not use this product until you have carefully read the following agreement.

This sets forth the terms and conditions for the use of this product. The installation of this product indicates that the BUYER has read and understands this agreement and accepts its terms and conditions. Performance products by their nature are designed to increase horsepower and performance not engineered in the original vehicle and the increased stress could result in damage to related systems. This is a high performance product – use at your own risk.

Snow Performance Inc., its agents, employees or owners shall not be under any liability whether in contract or otherwise whether or not resulting from our negligence or contents of information supplied for any damage or loss resulting from such information. The BUYER is responsible to fully understand the capability and limitations of his/her vehicle according to manufacturer specifications and agrees to hold the SELLER harmless from any damage resulting from failure to adhere to such specifications. The SELLER disclaims any warranty and expressly disclaims any liability for personal injury or damages. The BUYER acknowledges and agrees that the disclaimer of any liability for personal injury is a material term for this agreement and the BUYER agrees to indemnify the SELLER and to hold the SELLER harmless from any claim related to the item of the equipment purchased. Under no circumstances will the SELLER be liable for any damages or expenses by reason of use or sale of any such equipment.

The BUYER is responsible to obey all applicable federal, state, and local laws, statutes, and ordinances when operating his/her vehicle, and the BUYER agrees to hold SELLER harmless from any violation thereof. The SELLER assumes no liability regarding the improper installation or misapplication of its products. It is the installer's responsibility to check for proper installation and if in doubt, contact the manufacturer.

Install Notes

Pump Setting _____(psi)

Nozzle Size _____(ml/min)

Boost / Vacuum setting _____

Misc:

Step 3 Nozzle Selection

Nozzle sizing is a function of horsepower, which approximates the engine airflow, and boost, which approximates intake charge heat.

Recommended starting points:

250 - 350 RWHP:	175ml/min nozzle.
350 - 475 RWHP:	375ml/min nozzle
475 - 600 RWHP	625ml/min nozzle

 **TECH TIP** Seal the nozzle into the nozzle holder using **GOOP** sealant. Using a sealant that is not permanent will allow for nozzle changes during tuning. Simply remove the nozzle, clean the threads, and reinstall using sealant.

Assemble desired nozzle into nozzle holder using methanol resistant sealant. **The end of the nozzle with the fine mesh screen is to be inserted into the nozzle holder.** Torque at least 1/2 turn past hand tight.



Correct



Incorrect

NOTE: If nozzle is mounted lower than the reservoir, a Solenoid Upgrade (#40060) must be used to prevent draining.

Step 4 Nozzle Mounting

The nozzle assembly should be installed 90° to the direction of airflow. On round intake tubes, this is 360° around the tube meaning the nozzle can be mounted in any direction. This will ensure maximum cooling as the nozzle sprays in a cone pattern. Choose and mark mounting location on air intake for nozzle placement.

Drill and tap (1/32" pre-drill, 1/8"-27 NPT tap) air inlet tube as close as possible to throttle body/throttle plate.



The nozzle is mounted into the intake using its external 1/8 NPT threads. Tighten the nozzle and nozzle holder assembly one half turn past hand tight using methanol resistant sealant to seal the threads.

You can mount the nozzle in a plastic or rubber air inlet tube using a Nozzle Mounting Adapter (#40110).

TECH TIP The recommended nozzle mounting point is before the throttle body/plate. If you mount the nozzle after the throttle body/plate, a Solenoid Upgrade (#40060) must be used to prevent siphoning at idle.

Solenoid Upgrade (optional)

The optional Solenoid Upgrade (#40060) is required if the nozzle is to be installed after the intake throttle plate, or the fluid reservoir is mounted higher than the nozzle.

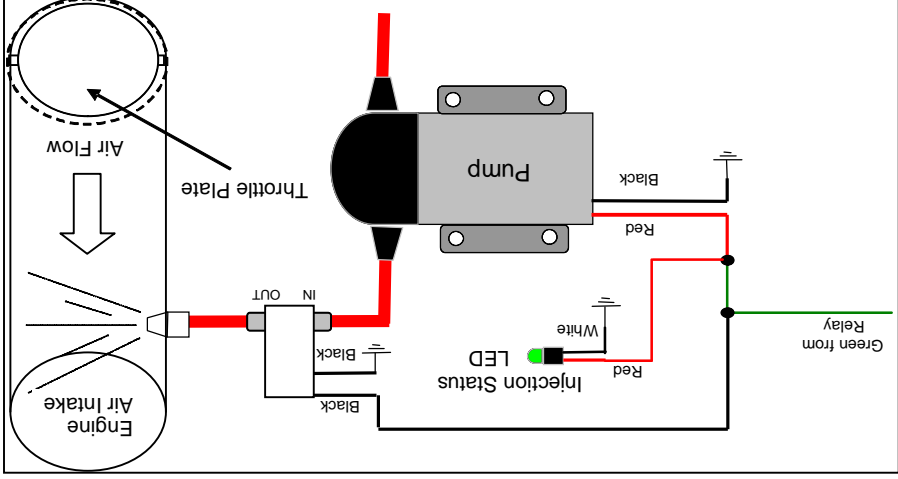

Hand thread the two 1/8" NPT quick connect fittings into ports labeled IN and OUT on the solenoid. Tighten an additional half turn.

Cut high pressure line at location solenoid is to be installed. Insert ends of cut line into quick connect fittings of solenoid. The port labeled IN is the inlet and the port labeled OUT is the outlet. Firmly pull on line to check secure connection. If line pulls out, re-insert farther into fitting to engage locking clips. If high pressure line removal is required, firmly press in plastic fitting ring to disengage locking clips while pulling hose from fitting.

Connect one of the BLACK wires from solenoid to the RED positive pump wire. Note that connecting the wire to any other power source other than the pump wire will result in improper operation of solenoid. Connect the second BLACK wire to a secure chassis ground location.

Fluid Level Switch (optional)

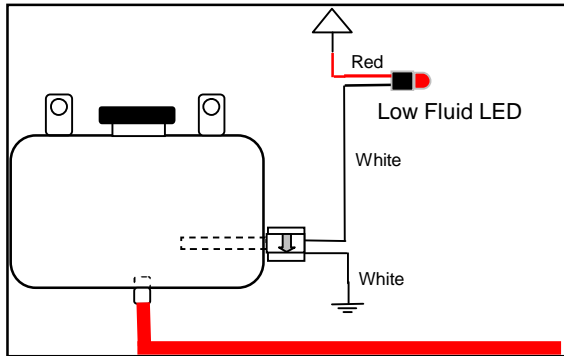

Instructions

- After mounting reservoir, mount red LED in dash next to the green "injection" LED is usually easiest.
- Wire LED per diagram with Red wire to a 12v key-on source, and the White wire to one of the White wires of the level switch.
- Connect other White wire of the level switch to vehicle ground.
- With key-on source enabled, the red LED should be "on" with no fluid in the reservoir. Upon filling the reservoir, the red LED should be "off".



TECH TIP The level switch is designed to indicate when there is less than 1" of fluid in the reservoir.

Step 5 Nozzle Connection

Measure the distance from the pump outlet to the nozzle holder.

Cut the 1/4" red tubing using utility knife. Make cuts are as square as possible.

Ensure there are no kinks in the tubing and insert tubing into quick disconnects until fully seated.

Gently pull on tubing to ensure a good connection.

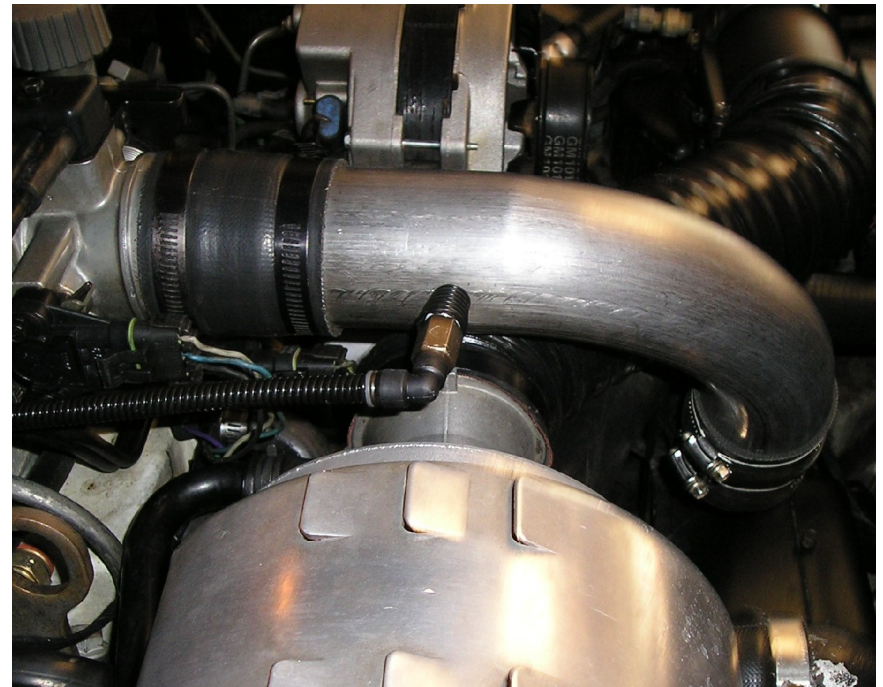

Use tie wraps to help route tubing and to ensure it doesn't contact moving or hot parts in the engine compartment.

Installation - Electrical

Variable Controller Installation



The figure above shows the back view of the VC-MAF controller. Attach controller to secure location with easy access in engine bay or passenger compartment. The VC series controllers are designed to withstand engine bay conditions, but should not be mounted directly to the engine block. Plug wire harness into back of controller. Note the terminal positions are numbered on the bottom side of wire harness connector. Your controller has an internal self resetting fuse such that an external automotive type fuse is not required. In the case of a fault the internal fuse will attempt to reset after about 1 minute.

CAUTION: Disconnect the negative battery terminal while connecting wires to prevent electrical fire or damage to controller.

- Connect GREEN wire at position 4 to Pump RED power wire.
- Connect RED wire at position 3 to +12V key on source. When selecting a 12V key-on source, try to find a dedicated circuit with at least a 15 AMP capability (25 AMP with 220psi pump).
- Connect YELLOW wire at position 2 to grey/red wire at MAF sensor.
- Connect BLACK wire at position 1 to a good ground location.

TECH TIP Always insure to have a good electrical ground connection. Poor ground will result in erratic operation of controller.

Maintenance – Remove nozzle(s) and clean screen filters at least once per year using carb cleaner.

The Boost Cooler® has been designed to operate with high concentrations of methanol. Oil or other additives are not required for system lubrication.

For best performance, cooling and system life it is recommend that Snow Performance Boost Juice™, part #40008, be the exclusive fluid used in the system.

Tuning Quick Reference

The kit enables the use of increased timing which provides for over 50% of the potential power increase(denser intake charge the remainder). All other factors being the same, if base timing is not increased over the non-Boost Cooler® settings, power increase will be less.

Increase base timing in 2 degree increments until the first hint of detonation - then back off 2 degrees (use 3rd gear pulls from 2000RPM).

If you install the kit and do not tune the engine, you will see minimal results. The kit is for detonation control and will allow more power yielding boost and/or timing to be utilized.

The Boost Cooler® adds an alternate fuel source as well as significantly cools combustion. With the Boost Cooler®, one does not need to cool combustion with overly rich air/fuel ratios. To minimize combustion quench, you should start with an air to fuel ratio of 12.0-12.5:1 with a conservative timing setting.

Injecting water/methanol lower than 3300-3500 RPM could result in combustion quench. All vehicles are different. If the engine bogs or loses power, then it is coming on too early, the quantity is too much, or there is not enough methanol in the mixture (50/50 water/methanol recommended).

If you have to increase the onset too high in the rpm range (detonation control is needed sooner), decrease pump pressure and/or go to a smaller nozzle.

In the black head of the pump, there is a 2mm Allen head screw that will regulate the pressure. On the 150 psi pump, for every full turn counter clockwise you will decrease the pump pressure by 18-20 psi. On the 220 psi pump it will decrease the pump pressure 20-22psi for every turn counter clockwise.

When increasing the pump pressure, the allen screw will become tight. This is full pressure. **BE CAREFUL NOT TO OVERTIGHTEN.** If you go too far on the screw clockwise, then you can strip out the plastic threads.

Setting MAF Sensor Type

The VC-MAF controller is designed to work with four different types of vehicle MAF sensors. A three position switch located inside the VC-MAF allows the selection of the MAF sensor type. The VC-MAF only reads the selection switch on power up to determine the mode of operation. The switch selection can be changed at any time, but power to the VC-MAF needs to be cycled before the new selection will be used.

To access the MAF selector switch, remove the clear plastic plug located to the left of the wire harness connector on the back of the VC-MAF. The default setting is all switches in the OFF or UP position. This selects a 0-5 volt output type of MAF sensor.

Switch Position			MAF Type
1	2	3	
OFF	OFF	OFF	0-5 volt hotwire
ON	OFF	OFF	1994 and newer GM
OFF	ON	OFF	Mitsubishi/Dodge
OFF	OFF	ON	1993 and older GM

Note: Only one switch can be in the ON or OWN position at a time. If more then one switch is in the ON position, the VC-MAF will not control injection properly.

Variable Controller Tuning

- Adjust the "Start" level first by turning dial clockwise to about 1 volt higher then the set point found in the "Test Controller" section below. This sets the Air Flow sensor voltage required to activate the injection system.
- Next, adjust "Full" level to the Air Flow sensors max voltage output.
- Note - over lapping the settings, where the Full dial is lower then Start, will result in max injection at the onset point.
- Road test vehicle and adjust Full dial until a smooth power curve is felt with no misfiring.



Controller Operation Example

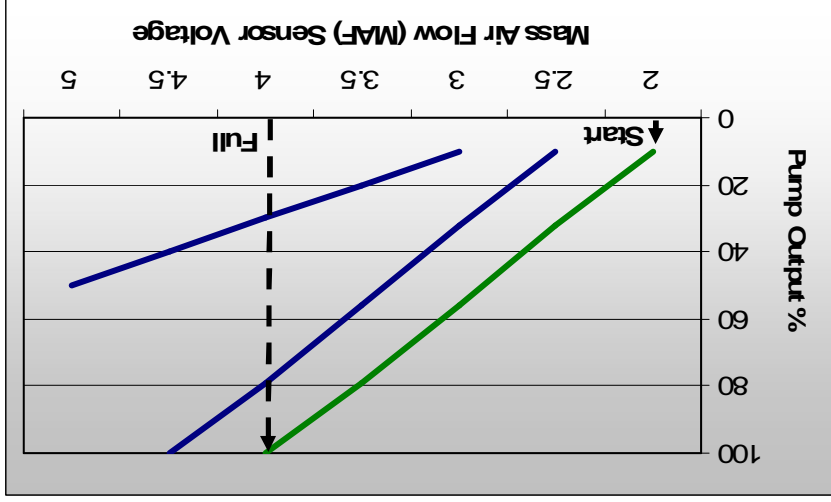

For setting 1, GREEN, the chart shows the Start dial at 2 volts and the Full dial at 4 volts. At 2 volts from the MAF, the pump will operate at 10%. At 4 volts from the MAF, the pump will deliver 100% of injection pressure.

For MAF voltage readings between the Start and Full settings, the controller will linearly adjust the pump output as shown on the graph.

Testing the System

Step 1 Test Pump and Mechanical System

Disconnect pump from controller. Using a 12 volt source, apply power to red wire of pump. Pump should activate, green LED should go on, and fluid level in tank should go down. It is recommended to also check the nozzle spray pattern while following this procedure. Also check for leaks.

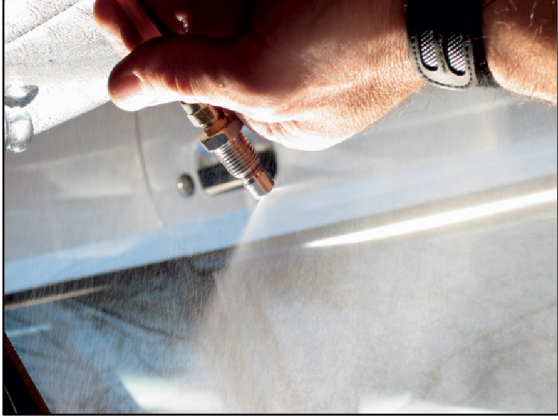

If pump goes on and fluid level doesn't go down, there is an obstruction in the tube or nozzle. Activation of pump for short periods (2 - 5 sec.) will not cause engine damage.

Step 2 Test Controller

- Begin the testing process with both dials on the VC-MAF at their highest settings (clockwise).
- Turn ignition key on so that the system has 12volt power. If the pump runs, inspect ground wires for secure connection and repair as needed.

The Pump should be off at this point, start vehicle. Slowly turn the Start dial lower (counter clock wise) until the pump activates. If the lowest setting is reached without pump activating, it may be necessary to rev engine to increase airflow signal to the controller. Turn Start dial back up (clockwise) until pump shuts off.