



INSTALLATION INSTRUCTIONS



2004-13 NISSAN TITAN 6" BASIC & PERFORMANCE SYSTEMS

FTS25001 - FTS25002 - FTS250001

Fabtech Motorsports | 4331 Eucalyptus Ave. Chino, CA 91710

Tech Line: 909-597-7800 | **Fax:** 909-597-7185 | **Web:** www.fabtechmotorsports.com



- PARTS LIST -

	FTS25002	COMPONENT BOX 1
1	FTS60001D	Driver Side Knuckle
1	FTS60001P	Passenger Side Knuckle
2	FT60021BK	Strut Assembly Spacer
1	FTAS12	Sticker
1	FTAS16	Driver Warning
1	FTREGCARD	Registration Card

	FTS25001	COMPONENT BOX 2
4	FT1500U	U-Bolt
2	FT205	Add-A-Leaf
2	FT30064	Impact Tube Mounts
1	FT60002BK	Front Crossmember
1	FT60003BK	Rear Crossmember
1	FT60004BK	Driver Front Bump Stop
1	FT60005BK	Passenger Front Bump Stop
2	FT60006BK	Front Sway Bar End Link
1	FT60008BK	Skid Plate
1	FT60052	Hardware Sub-Assembly Kit
1	FT60050	Hardware Sub-Assembly Kit
2	FT70011BK	Impact Tube
2	FTBK2	Block

	FT60050	HARDWARE SUB-ASSEMBLY
2	12008007100	Zip Tie
4	31000005052	5/16 SAE Flat Washer
2	31180003352	5/16-18 C-Lock Nut
2	31181001081	5/16-18 x 1" Hex Cap Bolt
2	CB-06X5	Center Pin
1	FT1044	Bushing Kit
2	FT25001i	Instruction Sheet
1	FT50048	End Link Bushing Kit
1	FT50089	End Link Sleeve Kit
1	FT60007	Rear E-Brake Bracket
2	FT60014	Front Bump Stop Nut Tab
2	FT60019	Factory Skid Plate Bracket
2	FT60020	Brake Line Nut Tab
2	FT60026	Cam Bolts
1	FT60027	Driver Steering Stop
1	FT60028	Pass. Steering Stop
2	FT70014	Rear Brake Line Bracket
1	FT97150-6-106	Rear Diff Mount Spacer
2	37240003952	Center Pin Nut

	FT60050 - HARDWARE	LOCATION
4	9/16"-12 x 4 1/2" Hex Bolt	Front/Rear crossmember
4	9/16"-12 C-Lock Nut	
8	9/16" SAE Flat Washer	
2	1/4"-20 X 1" Hex Bolt	Brake line
2	1/4"-20 Nyloc Nut	
4	1/4" SAE Flat Washer	
2	Adel Clamp	Brake line
10	3/8"-16 X 1 1/4" Hex Bolt	Bump stop
8	3/8"-16 Nyloc Nut	
18	3/8" SAE Flat Washer	
2	3/8" Split Washer	
2	1/4"-20 x 1 1/4" Hex Bolt	
2	1/4" SAE Flat Washer	
4	1/2"-13 x 3" Button Head Bolt	Sway bar
8	1/2" SAE Flat Washer	
4	1/2"-13 Nyloc Nut	
6	7/16"-14 C-Lock Nut	Shock
6	7/16" SAE Flat Washer	
4	1/8" x 2 Cotter Pin	
2	3/16" x 2" Cotter Pin	
2	9/16"-12 x 4 1/2" Hex Bolt	Diff
1	9/16"-12 x 4" Hex Bolt	
3	9/16"-12 C-Lock Nut	
6	9/16" SAE Flat Washer	
4	7/16"-14 x 3 1/2" Hex Bolt	Impact Struts
4	7/16"-14 Nyloc Nut	
8	7/16" SAE Flat Washer	
2	1/2"-13 x 2 1/2" Hex Bolt	Skid plate
1	1/2"-13 x 1 1/2" Hex Bolt	
2	1/2"-13 Nyloc Nut	
1	1/2" Split Washer	
5	1/2" SAE Flat Washer	
2	1/4"-20 x 1 1/4" Hex Bolt	Brake line
2	1/4"-20 x 3/4" Hex Bolt	
4	1/4"-20 Nyloc Nut	
8	1/4" SAE Flat Washer	
2	8mm-1.25 x 30mm Hex Bolt	Brake line
2	8mm Flat Washer	
2	8mm Split Washer	
8	9/16-18 Nyloc Nut	
8	9/16 SAE Washers	
1	Lock Tight	
4	Zip ties	

- TOOL LIST -

Required Tools (Not Included)

Floor Jack & Jack Stands
Assorted Metric and S.A.E sockets, and wrenches
Torque Wrench
Die Grinder w/cut off wheel & grinding wheel
Heavy Duty Ratchet Strap

- PRE-INSTALLATION NOTES -

Read this before you begin installation-

Check all parts to the parts list above before beginning installation. If any parts are missing contact Fabtech at 909-597-7800 and a replacement part will be sent to you immediately.

Read all instructions thoroughly from start to finish before beginning the installation. If these instructions are not properly followed severe frame, driveline and / or suspension damage may occur.

Check your local city and state laws prior to the installation of this system for legality. Do not install if not legal in your area.

Prior to the installation of this suspension system perform a front end alignment and record. Do not install this system if the vehicle alignment is not within factory specifications. Check for frame and suspension damage prior to installation.

The installation of this suspension system should be performed by two professional mechanics.

Use the provided thread locking compound on all hardware.

Do not combine this suspension system with any other lift device or parts.

This suspension must be installed with Fabtech shock absorbers.

WARNING- Installation of this system will alter the center of gravity of the vehicle and may increase roll over as compared to stock.

For technical assistance call: 909-597-7800 or e-mail: info@fabtechmotorsports.com

Larger tires cannot be installed on the OEM wheels. If vehicle is equipped with Factory 18" wheels, you must use 18" wheels or larger.

Vehicles that receive oversized tires should check ball joints, tie rods ends, pitman arm and idler arm every 2500-5000 miles for wear and replace as needed.

On 2WD trucks, an FTS95000 Carrier Bearing Spacer must be installed to prevent driveline vibration.

Verify differential fluid is at manufactures recommended level prior to kit installation. Installation of the kit will reposition the differential and the fill plug hole may be in a different position. (For example, if the manufacture recommends 3 quarts of fluid, make sure the diff has 3 quarts of fluid). Check your specific manual for correct amount of fluid.

Recommend Tires and Wheels:

Use 315/70R17 tire w/ 17x8 wheels w/ 5" BS w/ minor trimming

- INSTRUCTIONS -

FRONT SUSPENSION

1. Disconnect the negative terminal on the battery. Jack up the front end of the truck and support the frame rails with jack stands. **NEVER WORK UNDER AN UNSUPPORTED VEHICLE!** Remove the front tires.
2. Remove the factory differential skid plate and discard. If the truck is equipped with the optional ALUMINUM bumper to crossmember skid plate, remove it and save along with the hardware. If it is equipped with factory black STEEL skid plate, remove and discard, it will not go back onto the vehicle.
3. Disconnect the tie rod ends from the steering knuckle by striking the knuckle to dislodge the tie rod end. USE CARE NOT TO DAMAGE THE THREADS ON THE TIE ROD END WHEN REMOVING. Save the hardware.
4. Locate the sway bar end links and remove from the factory lower control arms and the sway bar. Discard the end links and hardware.
5. Working from the driver side of the truck, remove the brake caliper and place it next to the frame. DO NOT HANG THE BRAKE CALIPER FROM THE BRAKE HOSE. Retain the hardware for reinstallation. Remove the brake rotor and save. Unplug the ABS wire at the plug next to the upper control arm and remove all the ABS line clips. Remove the ABS line bracket from the backside of the spindle and save along with the hardware. DO NOT DISCONNECT THE ABS SENSOR FROM THE BEARING ASSEMBLY.
6. Remove the cotter pin and nut from the C.V. Axle at the spindle and save the nut and discard the cotter pin.
7. Remove both upper and lower ball joint nuts and save. Using a large hammer strike the spindle to dislodge the ball joints from the spindle. Remove the spindle from the upper ball joint first than the C.V. axle from the hub bearing, than from the lower ball joint. USE CARE TO NOT DAMAGE THE THREADS ON THE BALL JOINTS WHEN REMOVING. SEE FIGURE

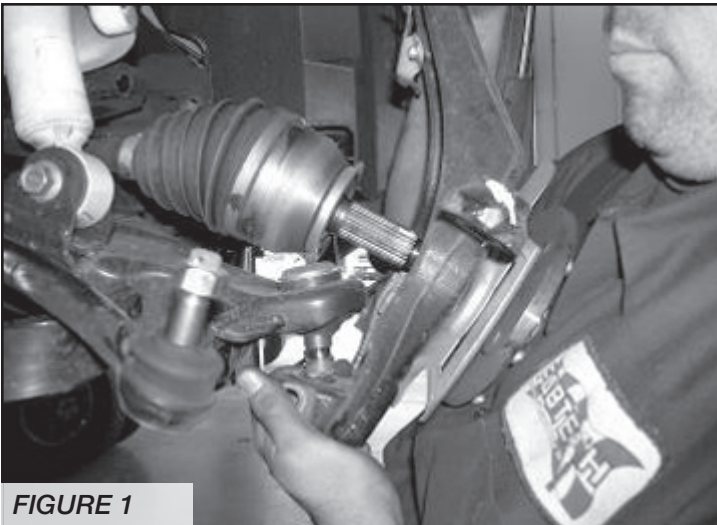

FIGURE 1

8. Remove the hub assembly from the stock spindle and save along with the hardware. Discard the spindle.
9. Remove the three upper strut assembly bolts from the truck and save. Remove the lower shock bolt and save. Remove the strut assembly from the truck and save. The factory shock assembly will be reused if you are installing the 6" Basic System. If you are installing the 6" Performance System you can discard the factory shock assembly.
10. Remove the C.V. Shaft from the differential. Save the shaft and the hardware.
11. Remove the lower control arm from the factory pivots and discard the factory alignment cams.
12. Repeat steps five through eleven on the passenger side of the truck
13. Working on both sides of the truck, remove the factory rear crossmember from the truck and discard the crossmember and hardware. SEE FIGURE

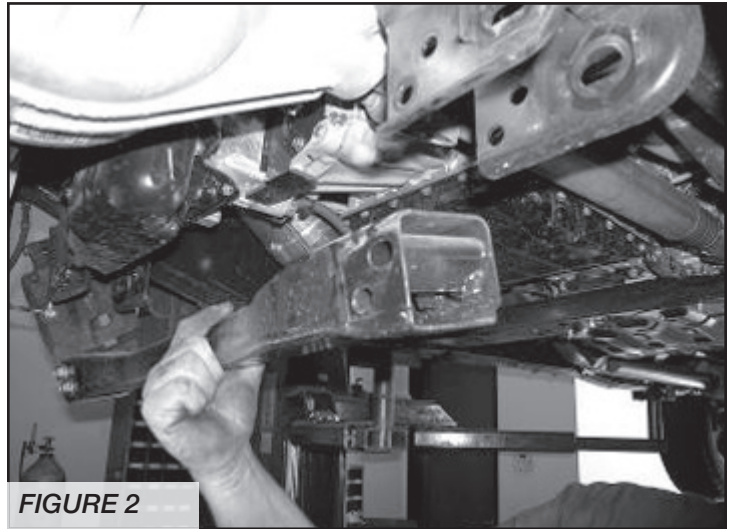

FIGURE 2

14. Disconnect the front drive shaft from the front differential and save the hardware. Disconnect the vent hose from differential.
15. Remove the front differential from the truck and discard the factory hardware.

16. Locate the factory differential mount next to the driver side rear lower control arm pocket. Cut a 4 1/2" by 2" section of the frame mount from the truck. (this cut must be made on 4wd and 2wd trucks) SEE FIGURE

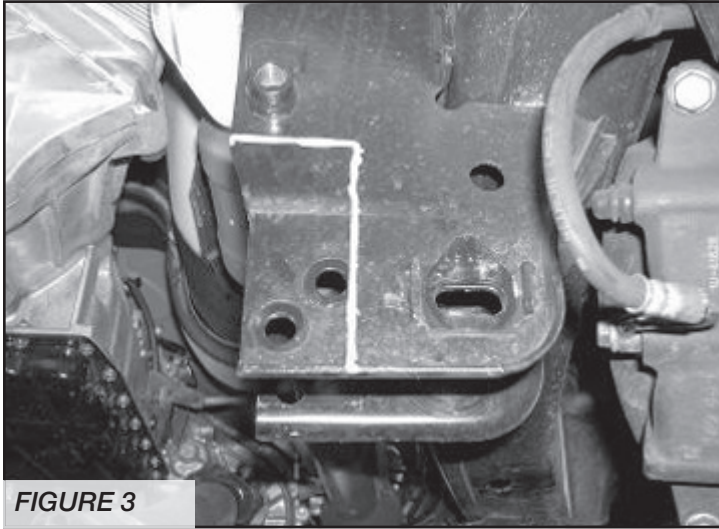

FIGURE 3

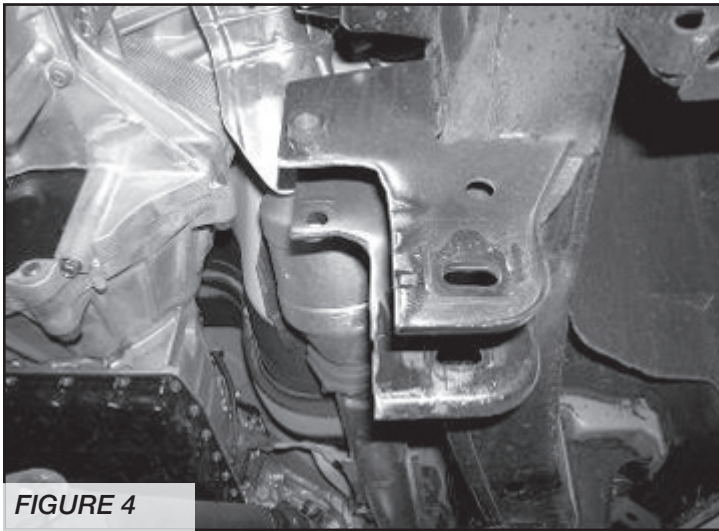

FIGURE 4

17. Locate the driver side front differential mount and cut 1" off the end of the mount on the frame. SEE FIGURE

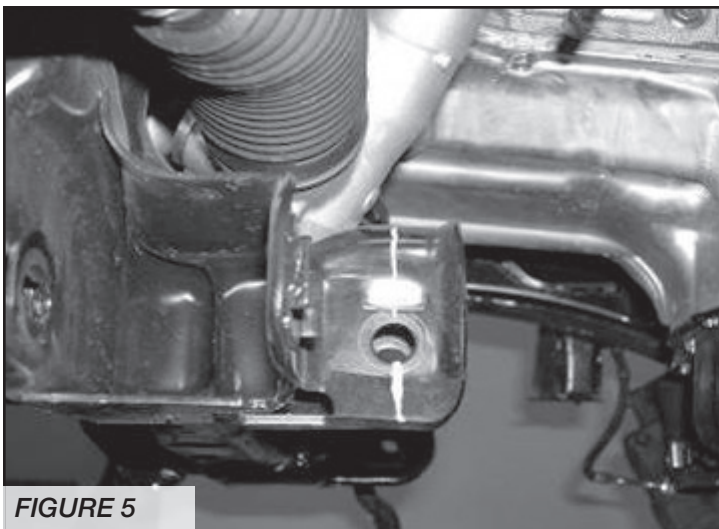

FIGURE 5

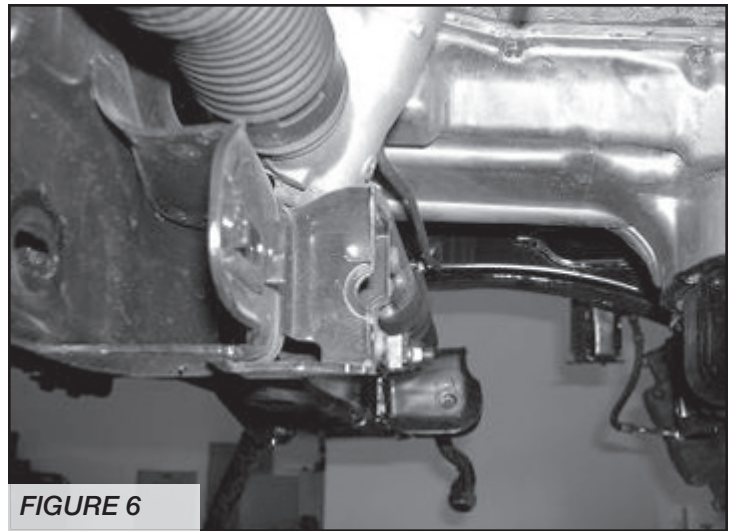

FIGURE 6

18. Locate FT60002 Front Crossmember. Using the supplied 9/16" x 4 1/2" bolts, nuts, and washer attach the crossmember to the factory front lower control arm pockets. Leave loose at this time.
19. Reinstall the front differential back into the truck attaching the two front differential mounts on the differential to the new crossmember using the supplied 9/16" x 4" bolts, nuts, and washers on the passenger side diff mount and the supplied 9/16" x 4 1/2" bolt, nut, and washer on the driver side. Leave loose at this time. Using a HEAVY DUTY ratchet strap to support the rear of the differential as high as possible into the truck at this time.
20. Locate FT60003 Rear crossmember and attach to factory lower control arm pockets using the supplied 9/16" x 4 1/2" bolts, nuts, and washer. Leave loose at this time.
21. Lower the rear of the front differential down into the rear mount of the new rear crossmember. Attach the rear differential to the crossmember using the supplied 9/16" x 4 1/2" bolt, nut, and washers and FT97150-6-106 spacer. The spacer will be placed to the rear of the factory differential mount. Leave loose at this time. Remove the ratchet strap from the truck. SEE FIGURE

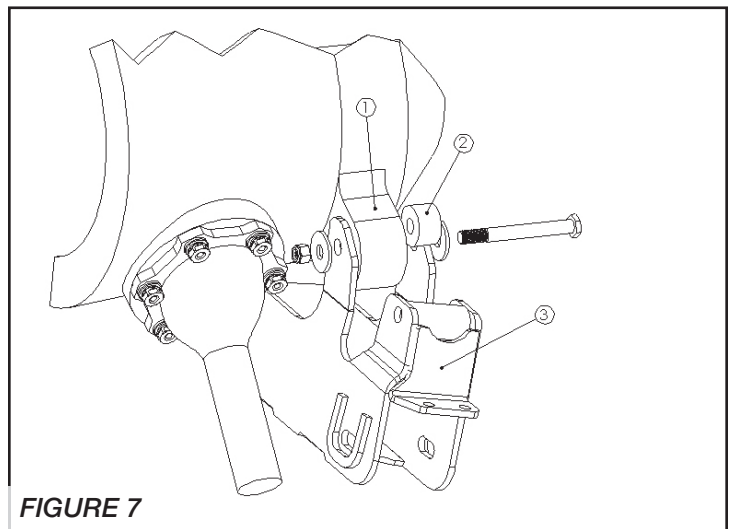

FIGURE 7

1. Front Differential
 2. FT97150-6-106 Spacer
 3. FT60003 Crossmember

22. Remove the previously installed driver front differential bolt. Locate FT60008 skid plate and install over the driver front differential mount and reattach using the same 9/16" bolt. Attach the rear of the skid plate to the rear crossmember using the supplied 1/2" x 1 1/2" bolt, split washer, and flat washer. SEE FIGURE

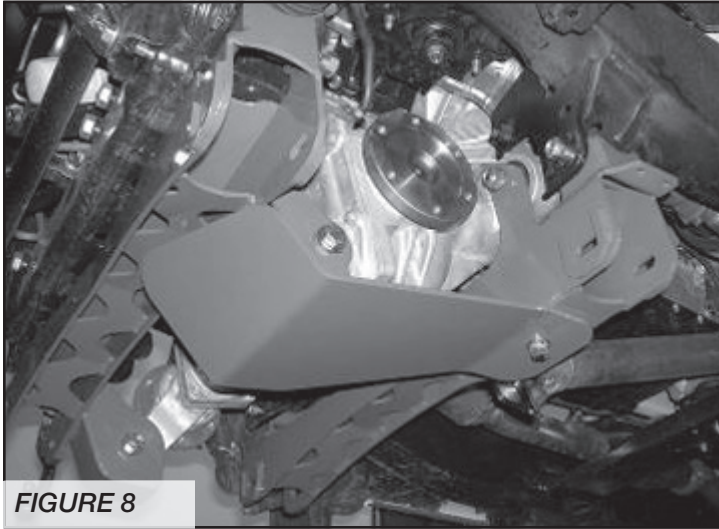

FIGURE 8

23. Locate the previously removed factory lower control arms. Attach them to the new crossmembers using the Supplied FT60026 alignment cams. When installing the alignment cams make sure they are in the middle of their adjustment. Once the cams are installed into the crossmember and tighten and torque to 75ft. lbs. SEE FIGURE

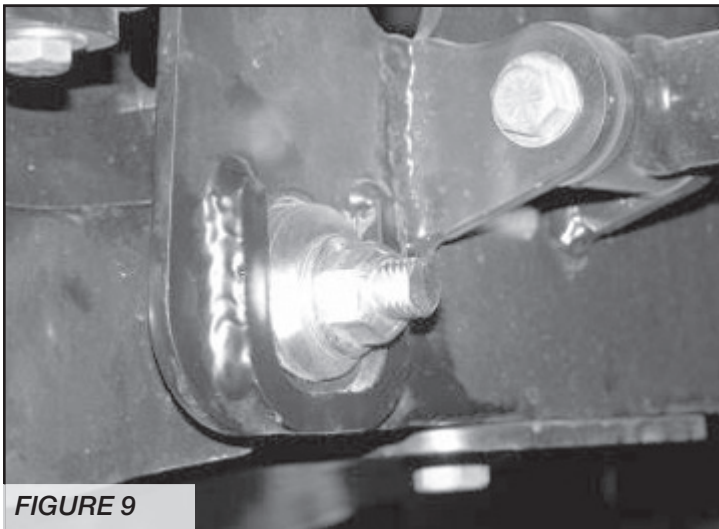

FIGURE 9

24. Torque the differential mount bolts to 90 ft. lbs. Torque the crossmember to frame bolts to 90 ft. lbs. Torque the 1/2" bolt on the skid plate to 55 ft. lbs. Reattach the front drive shaft to the differential and torque the bolts to 65 ft. lbs. Use a small amount of the supplied thread locking compound on the drive shaft bolts.

25. Locate FT60004 bump stop mount. Using the supplied 3/8" x 1 1/4" bolt, nuts, and washers attach the mount to the rear crossmember. Once attach mark the upper hole where the bump stop bracket meets the frame and drill a 3/8" hole. Using the supplied FT60014 nut tab and 3/8"x 1 1/4" bolts, flat washer, and split washer, attach the bump stop to the frame. Torque bolts to 30 ft. lbs. SEE FIGURE

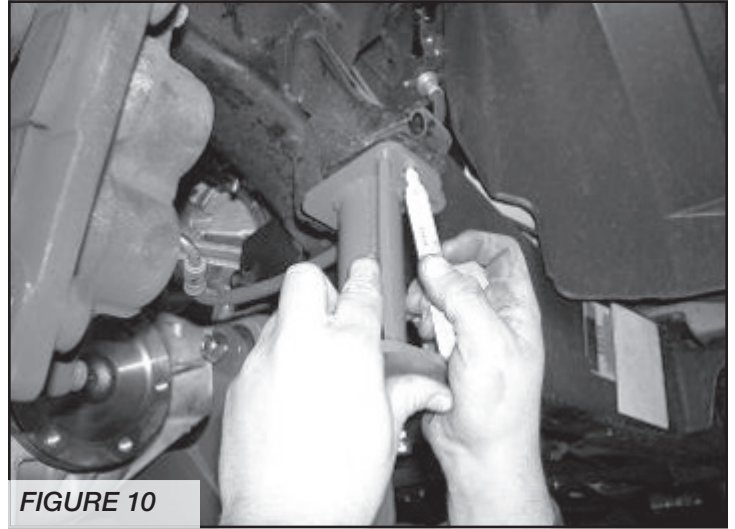

FIGURE 10

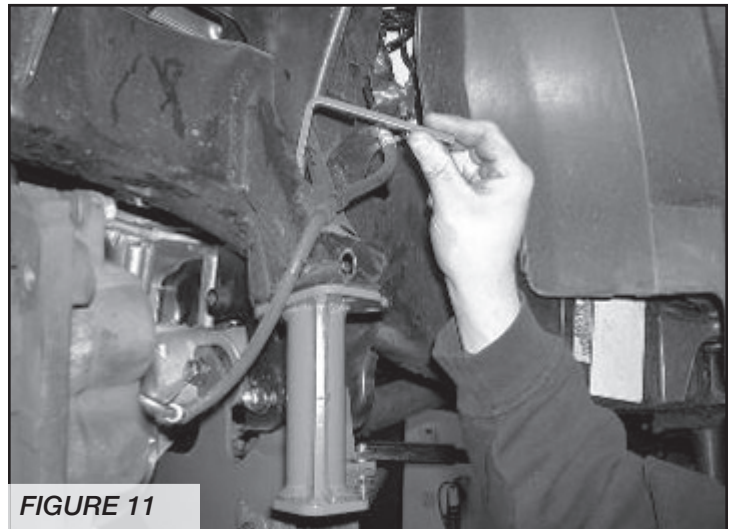

FIGURE 11

26. Working from the driver side of the truck, locate the previously removed C.V. shaft and attach to the differential using the original hardware. Torque to 65 ft. lbs.

FOLLOW STEPS 27-29 FOR BASIC KIT ONLY.

IF INSTALLING DIRT LOGIC 2.5 COILOVER SHOCKS, FOLLOW THE INSTRUCTIONS ENCLOSED WITH THE SHOCKS.

27. Using a drill with a 15/32" drill bit, drill the three upper strut mount holes out in the frame.

28. Locate the previously removed shock assembly and attach FT60021 spacer to the top of the stock assembly using the stock hardware. Use a small amount of the supplied thread locking compound on the strut to spacer hardware. You will need to index the spacer so the longer side of the spacer will be facing out board of the truck and the pigtail end on the bottom of the coil is facing inboard on the truck. (You may need to disassemble the coil over to get the pig tail to the inside). SEE FIGURE

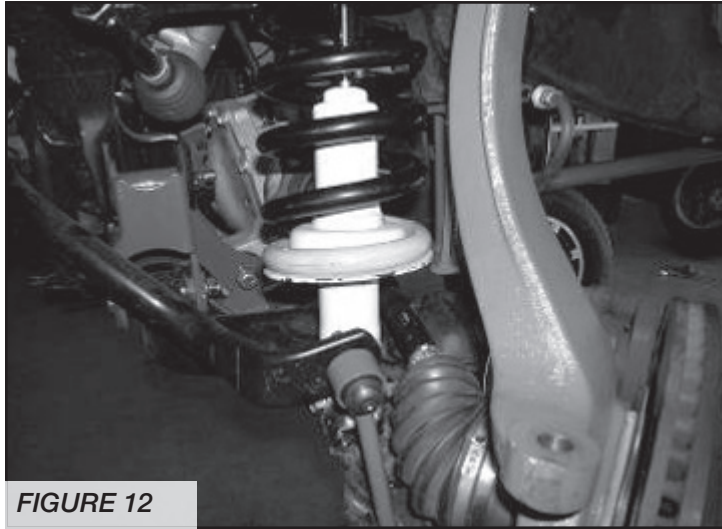

29. Install the complete shock assembly into the truck attaching the three upper bolts first using the supplied 7/16" C-lock and flat washers, leave loose. Then attach the lower mount to the original mount on the lower control arm using the original hardware. Torque upper hardware to 55 ft. lbs and the lower hardware to 90 ft. lbs. MAKE SURE THE LONGER SIDE OF THE STRUT SPACER IS FACING THE OUT BOARD SIDE OF THE TRUCK AND THE PIGTAIL END OF THE COIL SPRING ON THE BOTTOM OF THE COIL IS FACING INBOARD OF THE TRUCK.

30. Locate FTS60001D steering knuckle and install the previously removed bearing assembly using the original hardware along with a small amount of the supplied thread locking compound on each of the bolts. Torque the bearing bolts to 90 ft. lbs. Make sure the hub assembly with the dust shield is in the same position as it was on the factory spindle. Attach the previously removed ABS bracket to the back of the spindle in the same position using the stock hardware.

31. Attach the steering knuckle with the bearing assembly installed to the truck, first attaching it to the lower ball joint using the original hardware than attach to the upper ball joint using the original hardware. Torque the lower ball joint nut to 75 ft. lbs and the upper ball joint nut to 70 ft. lbs. Use one of the supplied small cotter pins to secure the upper ball joint nut. When installing the knuckle onto the truck make sure to push the C.V. axle end through the bearing assembly before attaching the upper ball joint.

32. Using the original C.V. Axle nut attach the axle to the bearing assembly. Torque to 160 ft. lbs. Using one of the supplied larger cotter pin to secure the bolt.

33. Repeat steps twenty-six through thirty-two on the passenger side of the truck.

Skip step 34 if working on 2012 models.

34. Working from both sides of the truck, route the ABS line up the back of the spindle to the ABS bracket on the spindle, then up to the ABS bracket on the frame, then finally connect it to the plug on the frame. SEE FIGURE



35. Working from the driver side, locate FT60027 Driver Steering stop and provided 5/16" hardware. Place the stop just below the bottom of the factory stop on the lower control arm and attach it with the 5/16" hardware. Torque to 20 ft. lbs. (NOTE: if there is damage to the factory steering stop, this must be repaired first so that the new stop fits flush against it). SEE FIGURE

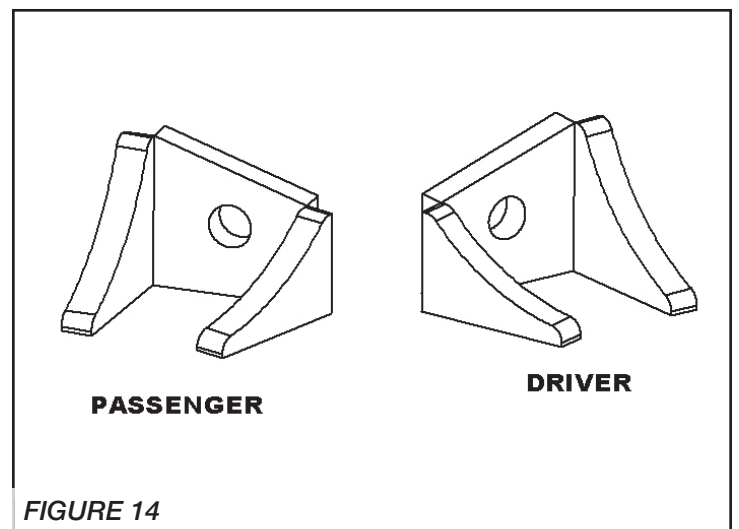

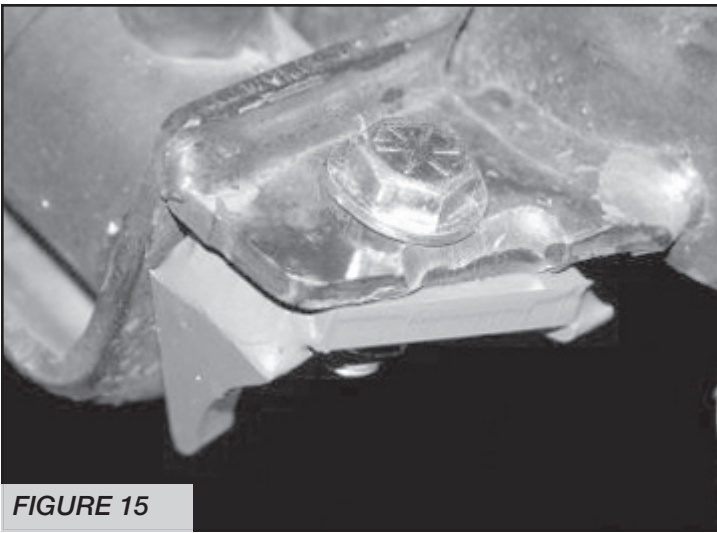

FIGURE 15

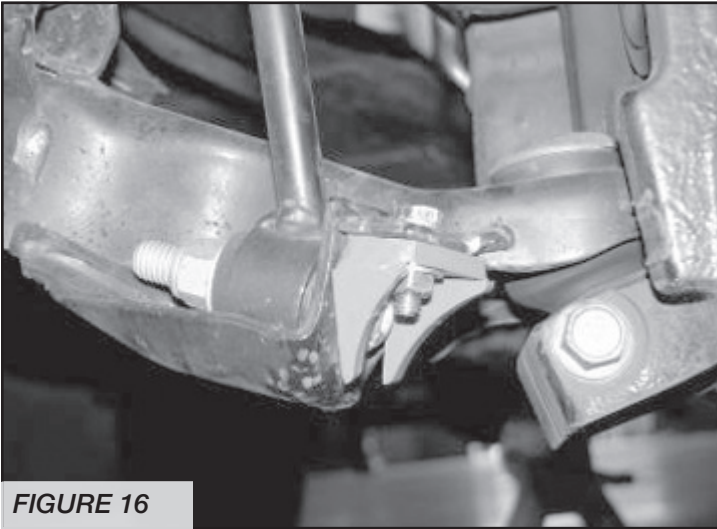

FIGURE 16

36. Repeat step 35 on passenger side of vehicle

37. Locate FT60006 Sway bar end links and install one of the supplied bushing and one of the supplied sleeves into each end of the end links. Using the supplied $\frac{1}{2}$ " x 3" button head bolts attach the end links to the truck as shown in the photo below. SEE FIGURE

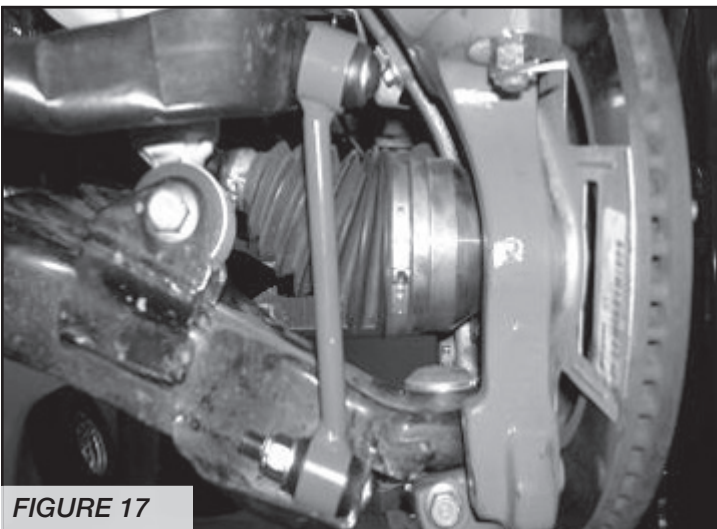

FIGURE 17

38. Locate the brass brake line union mounted on top of the frame. Remove the bolt attaching to the frame mount and discard the bolt. CAREFULLY pull the hard line 4" down on the frame

39. Locate the brake line tab where the soft line meets the hard line. Remove the clip that attaches the line to the frame and discard. Using a die grinder with a cut off wheel CAREFULLY cut the tab so the line can be removed from the mount. SEE FIGURE

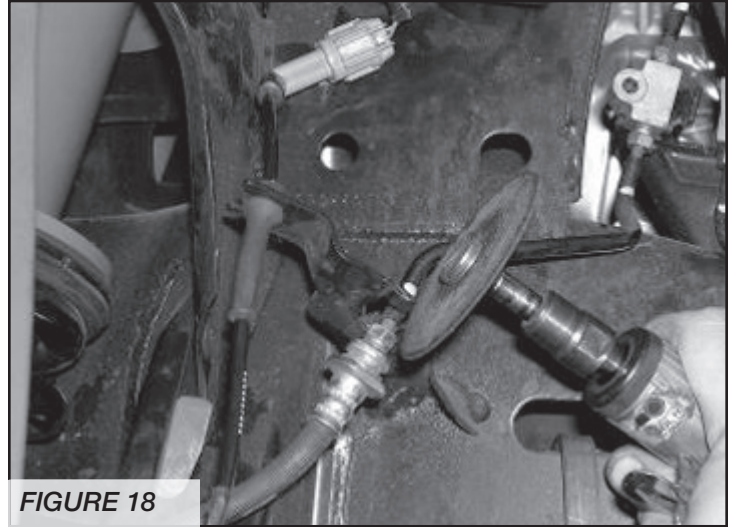

FIGURE 18

40. Reinstall the original brake rotor, followed by the brake caliper. Use a small amount of the supplied thread lock compound on the caliper bolts and torque to 100 ft. lbs.

41. Using the supplied $\frac{1}{4}$ " x 1" bolt, nut, and washers, along with one of the Adel clamps attach the brake line to the Fabtech bump stop mount. SEE FIGURE

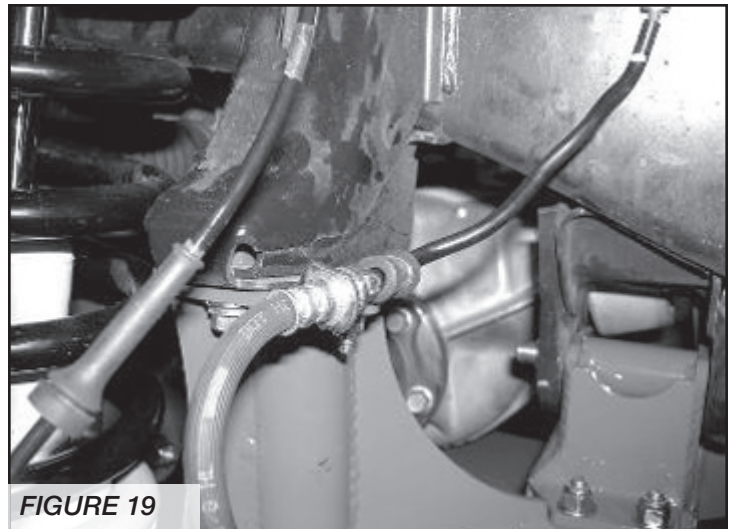

FIGURE 19

42. Locate FT60020 Brake Line nut tab and attach the brake line union to the frame using the supplied 1/4" x 1 1/4" bolt and flat washer. SEE FIGURE

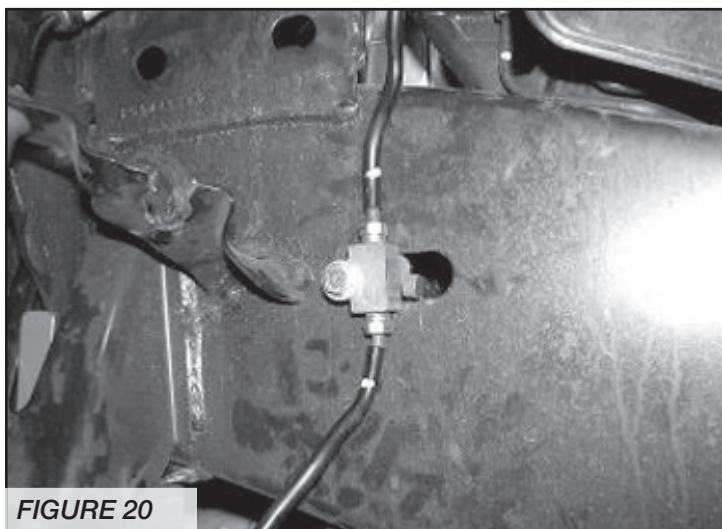

FIGURE 20

2012 models

43. Locate the 8mm-1.25 x 30 bolt, lock washer, and flat washer. Mount the front brake line junction block to the lower hole on the back side of the knuckle. Zip tie the wheel speed sensor wire to the back side of the knuckle. Torque the 8mm bolt to 17 ft-lbs. SEE FIGURE

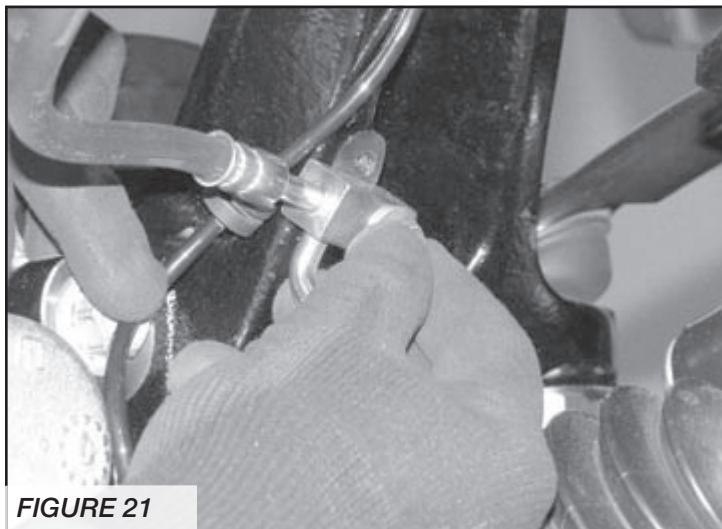

FIGURE 21

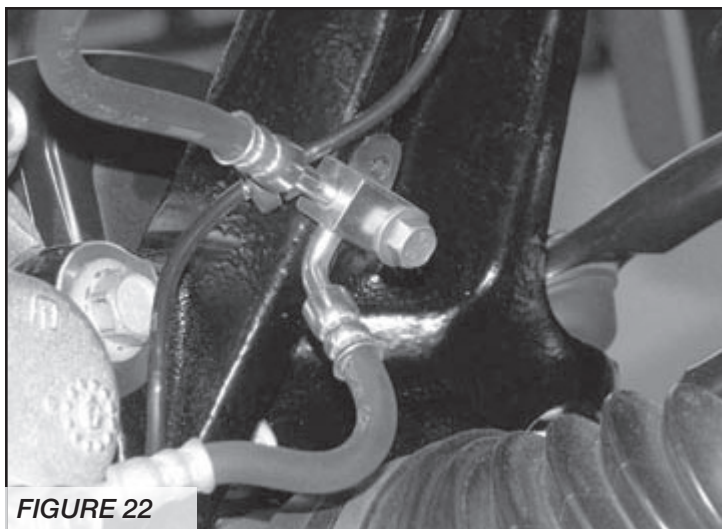

FIGURE 22



FIGURE 23

44. Remove both factory tie rod ends from the truck and put the driver's side tie rod end on the passenger side and the passenger side tie rod end on the driver's side. Attach the tie rod end to the spindle from the top down. Using the original castle nut, torque to 55 ft. lbs. Use one of the supplied small cotter pins to secure the nut. SEE FIGURE

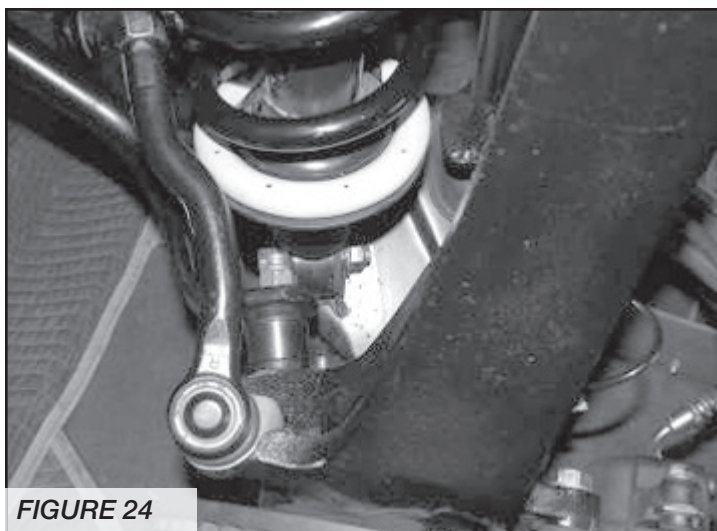

FIGURE 24

45. Locate FT70011 Impact tubes and install two bushings and one sleeve into each end on the impact tube. Using the supplied 7/16" x 3 1/2" bolts, nuts, and washers attach the impact tubes to the rear crossmember. Leave loose at this time.

46. Locate FT30064 Impact tube mounts and attach them to the other end of the impact tubes using the supplied 7/16" x 3 1/2" bolts, nuts, and washers. Raise the impact tube with the mount up to the transmission crossmember and mark the hole. Using a drill with a 1/2" drill bit, drill completely through the crossmember. Using the supplied 1/2" x 2 1/2" bolts, nuts, and washers attach the mounts to the frame. SEE FIGURE



FIGURE 25

47. Locate the optional ALUMINUM factory skid plate if the truck was equipped with it. Measure 3" up from the bottom and mark a straight line from side to side. Using a die grinder with a cut off wheel cut the 3" lower section off. SEE FIGURE

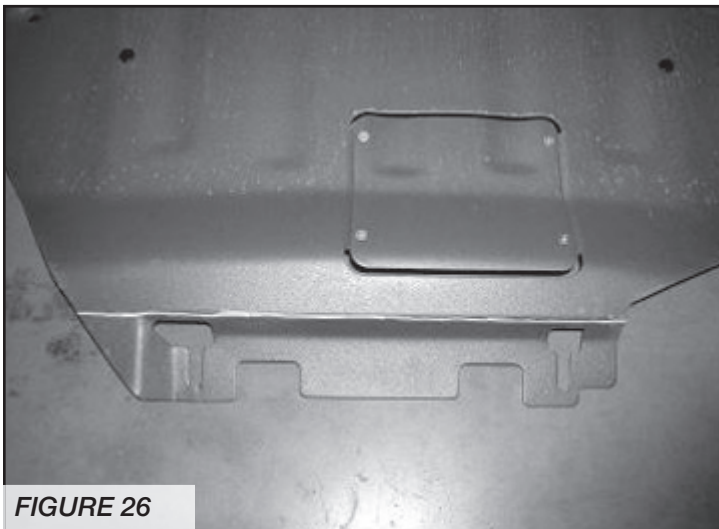

FIGURE 26



FIGURE 27

48. Install the skid plate back on to the truck using the stock bolts. Measure 3" out on both sides of the Fabtech Logo on the front crossmember and drill a 3/8" hole on both sides of the Logo plate. Attach the FT60019 Skid Plate brackets to the crossmember using the supplied 3/8" hardware. Line up the FT60019 brackets to the factory skid plate and drill a 3/8" hole, attach using the supplied 3/8" hardware. SEE FIGURE

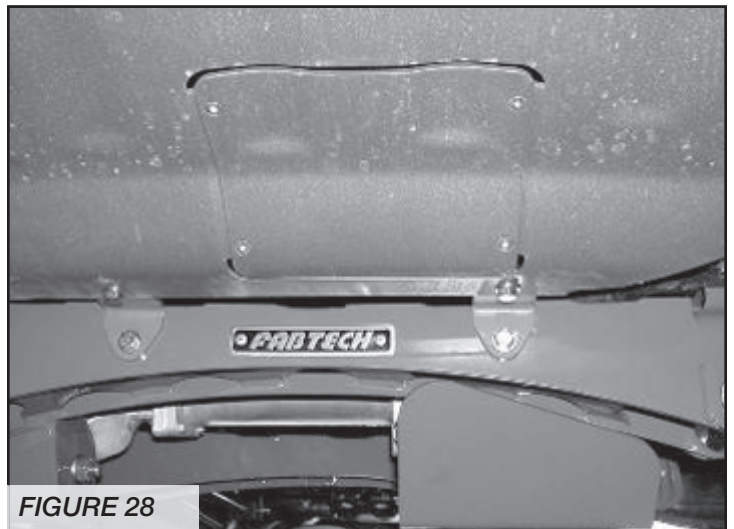

FIGURE 28

REAR SUSPENSION

49. Jack up the rear end of the vehicle and support the frame rails with jack stands. Block the front wheels. Release the parking brake at this time. Supporting the rear differential with a floor jack, do not allow the axle to hang freely.

50. Locate the factory e-brake bracket on the body of the truck, above the drive shaft, on the passenger side. Remove the two bolts attaching the bracket to the body and save the hardware. Locate FT60007 e-brake drop bracket and attach to the body using the original hardware. Attach the Fabtech bracket to the factory bracket using the supplied 1/4" x 3/4" bolt, nut, and washer. SEE FIGURE

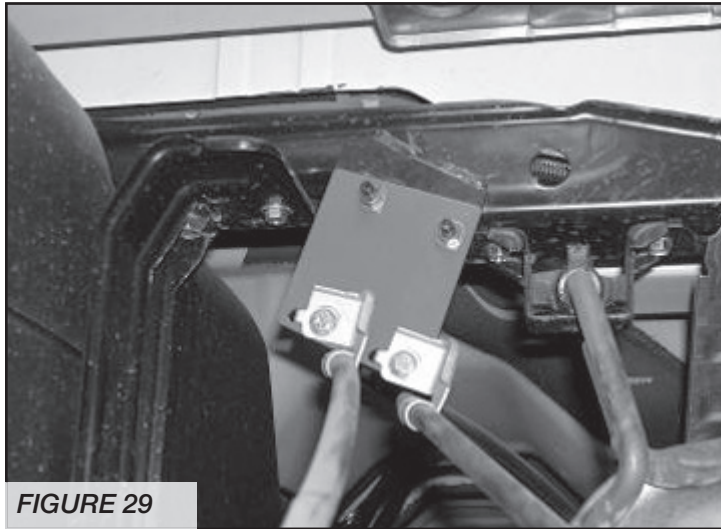

FIGURE 29

51. Locate the two factory brake line mounts on the driver side of the axle. Remove the factory cover bracket and discard. Remove both brake line brackets from the axle and discard the hardware. Locate the supplied brake line brackets FT70014 and attach to the axle using the supplied 8mm bolt, split, and flat washer. Using the supplied 1/4" x 1 1/4" bolts, nuts, and washers, attach the brake line to the new Fabtech bracket. Using one of the supplied zip ties attach the ABS line as shown below. Check the ABS line on the other side of the truck for proper clearance at this time also. SEE FIGURE

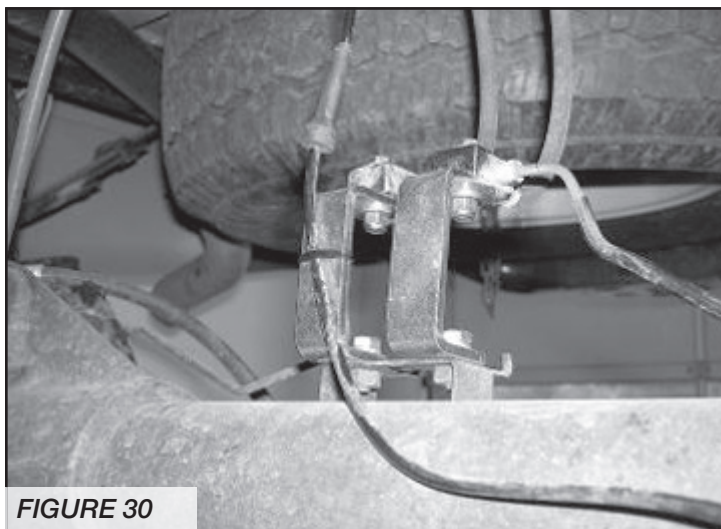

FIGURE 30

52. Remove the rear shocks and u-bolts, and lower the axle down. USE CARE NOT TO OVER EXTEND THE ANY BRAKE LINES. Discard the stock shocks and u-bolts.
53. Clamp the leaf spring in the middle of the spring and remove the center bolt

54. Separate the springs and install the provided add a leaf with the new center bolt in a pyramid pattern smallest on the bottom graduating to the longest on top. The factory flat overload leaf should remain on the bottom of the pack. Clamp the spring and tighten the center bolt as not to leave a gap between the springs. Cut the thread of the bolt smooth with the nut. The nut should be on the top of the leaf spring pack.
55. Locate and install the 2" rear lift blocks. The short end of the block should face to the front of the vehicle. Using the provided U bolts, nuts, and washers align axle, lift blocks, and springs, stock bump stop and torque the U-Bolts to 90lbs. SEE FIGURE

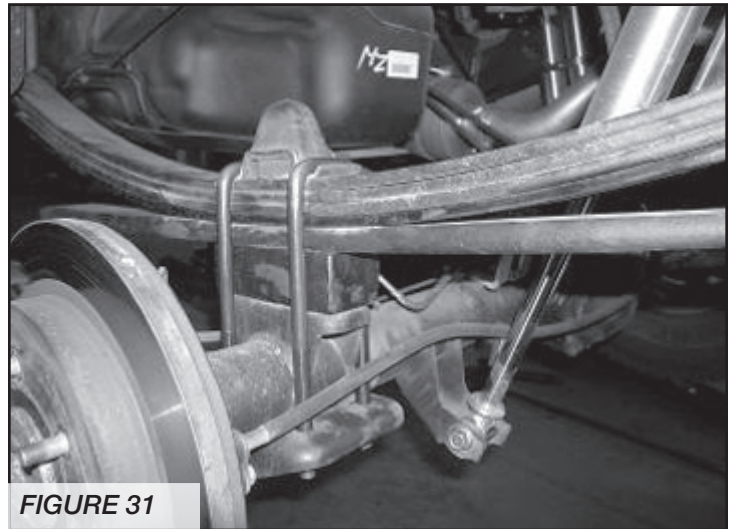

FIGURE 31

56. Install the new Fabtech shocks (not included with the kit) and Torque to 65 lbs using factory hardware on both upper and lower mounts.

If installing this kit on a 2WD truck, you must install the FTS95000 – Carrier Bearing Drop at this time. Follow the instructions included with the Carrier Drop kit

57. Install tires and wheels and torque lug nuts to wheel manufacturer's specifications. Turn front tires left to right and check for appropriate tire clearance. **Note - Some oversized tires may require trimming of the front bumper & valance.**
58. Check front end alignment and set to factory specifications. Readjust headlights.
59. Recheck all bolts for proper torque.
60. Recheck brake hoses, ABS wires and suspension parts for proper tire clearance while turning tires fully left to right.
61. Check the fluid in the front and rear differential and fill if needed with factory specification differential oil. **Note - some differentials may expel fluid after filling and driving. This can be normal in resetting the fluid level with the new position of the differential/s.**

62. Install Driver Warning Decal. Complete product registration card and mail to Fabtech in order to receive future safety and technical bulletins on this suspension.

63. Have vehicle properly aligned to factory specs.

Vehicles that will receive oversized tires should check ball joints and all steering components every 2500-5000 miles for wear and replace as required.

RETORQUE ALL NUTS, BOLTS AND LUGS AFTER 50 MILES AND PERIODICALLY THEREAFTER.

For technical assistance call: 909-597-7800

Completed install with optional Dirt Logic 2.5 Coilovers

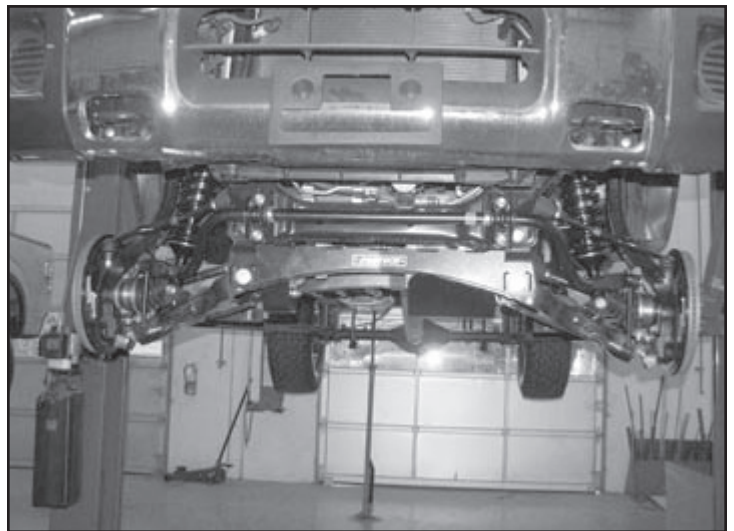
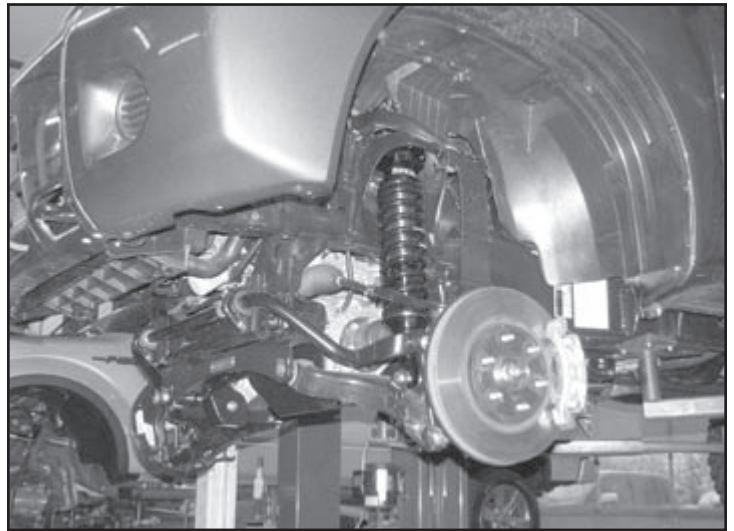
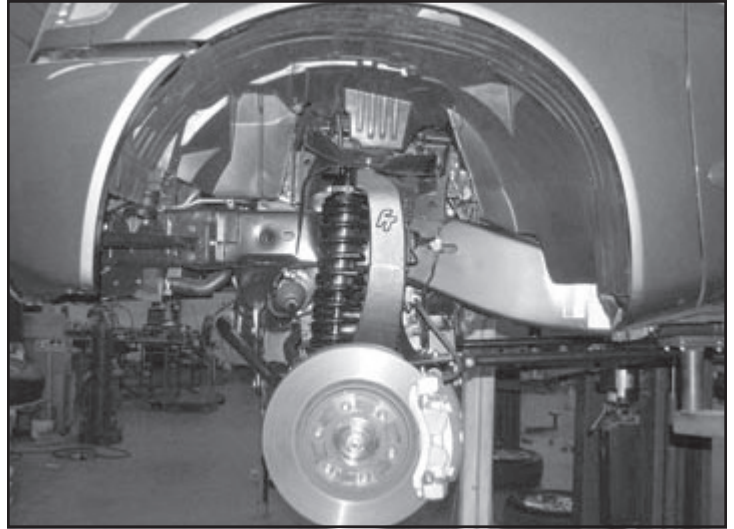

- Product Warranty and Warnings -

Fabtech provides a Limited Lifetime Warranty to the original retail purchaser who owns the vehicle, on which the product was originally installed, for defects in workmanship and materials.

The Limited Lifetime Warranty excludes the following Fabtech items; bushings, bump stops, ball joints, tie rod ends, limiting straps, cross shafts, heim joints and driveshafts. These parts are subject to wear and are not considered defective when worn. They are warranted for 60 days from the date of purchase for defects in workmanship.

Dirt Logic and Performance Coilover take apart shocks are considered a serviceable shock with a one year warranty on leakage only. Service seal kits are available separately for future maintenance. All other shocks are covered under our Limited Lifetime Warranty.

Fabtech does not warrant any product for finish, alterations, modifications and/or installation contrary to Fabtech's instructions. Alterations to the finish of the parts including but not limited to painting, powder coating, plating and/or welding will void all warranties. Some finish damage may occur to parts during shipping, which is considered normal and is not covered under warranty.

Fabtech products are not designed nor intended to be installed on vehicles used in race applications or for racing purposes or for similar activities. (A "RACE" is defined as any contest between two or more vehicles, or any contest of one or more vehicle against the clock, whether or not such contest is for a prize). This warranty does not include coverage for police or taxi vehicles, race vehicles, or vehicles used for government or commercial purposes. Also excluded from this warranty are sales outside of the United States of America.

Installation of most suspension products will raise the center of gravity of the vehicle and will cause the vehicle to handle differently than stock. It may increase the vehicle's susceptibility to a rollover, on road and off road, at all speeds. Extreme care should be taken to operate the vehicle safely at all times to prevent rollover or loss of control resulting in serious injury or death. Fabtech front end Desert Guards may impair the deployment or operation of vehicles equipped with supplemental restraining systems/air bag systems and should not be installed if the vehicle is equipped as so.

Fabtech makes every effort to ensure suspension product compatibility with all vehicles listed on the website, but due to unknown auto manufacturer's production changes and/or inconsistencies by the auto manufacturer, Fabtech cannot be responsible for 100% compatibility, including the fitment of tire and wheel sizes listed. The Tire and Wheel sizes listed in Fabtech's website are only a guideline for street driving with noted fender trimming. Fabtech is not responsible for damages to the vehicle's body or tires. Fabtech is not responsible for premature wear of factory components due to the installation of oversized tires and wheels.

Fabtech's obligation under this warranty is limited to the repair or replacement, at Fabtech option, of the defective product only. All costs of removal, installation or re-installation, freight charges, incidental or consequential damages are expressly excluded from this warranty. Fabtech is not responsible for damages and/or warranty of other vehicle parts related or non related to the installed Fabtech product. This warranty is expressly in lieu of all other warranties expressed or implied. This warranty shall not apply to any product that has been subject to accident, negligence, alteration, abuse or misuse as determined by Fabtech.

Fabtech suspension components must be installed as a complete system including shocks as shown on our website. All warranties will become void if Fabtech parts are combined and/or substituted with other aftermarket suspension products. Combination and/or substitution of other aftermarket suspension parts may cause premature wear and/or product failure resulting in an accident causing injury or death. Fabtech does not warrant products not manufactured by Fabtech.

Depending on the condition of the factory suspension components retained after the installation of a Fabtech suspension not all vehicles may have the same ride stance front to rear as described in the website. The blue color of suspension components shown in all Fabtech photographs are for display purposes only. Majority of all Fabtech components will be black specifically where noted with part numbers ending in BK.

Installation of Fabtech product may void the vehicles factory warranty; it is the consumer's responsibility to check with their local vehicle's dealer for warranty disposition before the installation of the product. Some state laws may prohibit modification of suspension to a vehicle in whole or in part. It is the responsibility of the installer and consumer to consult local laws prior to the installation of any Fabtech suspension product to comply with such written laws.

It is the responsibility of the distributor and/or the retailer to review all warranties and warnings of Fabtech products with the consumer prior to purchase.

Fabtech reserves the right to super cede, discontinue, change the design, finish, part number and/or application of parts when deemed necessary without written notice. Fabtech is not responsible for misprints or typographical errors within the website or price sheet. For the most recent Product Warranty and Warnings visit our website www.fabtechmotorsports.com