



INSTALLATION INSTRUCTIONS



2007-17 JEEP WRANGLER 2DR/4DR REAR COILOVER CONVERSION KIT

FT24109i

Fabtech Motorsports | 4331 Eucalyptus Ave. Chino, CA 91710

Tech Line: 909-597-7800 | Fax: 909-597-7185 | Web: www.fabtechmotorsports.com

- PARTS LIST -

FTS24109 COMPONENT BOX 1		
1	FT50426BK	REAR SUB FRAME
1	FT50427BK	LOWER SHOCK MOUNT (DRIVER)
1	FT50428BK	LOWER SHOCK MOUNT (PASSENGER)
1	FT50429BK	SKID PLATE
1	FT50430	HARDWARE SUBASSEMBLY

FT50430 HARDWARE SUBASSEMBLY		
2	FT50195	FRAME NUT TAB (OUTER)
2	FT30201	FRAME NUT TAB (INNER)
2	FT50327	REAR SHOCK MOUNT NUT TAB
1	FT50431	HARDWARE KIT
2	FT50432	NUT TAB (BUMPER MOUNT)
1	FT24109i	INSTRUCTIONS
4	FT50557	SUB FRAME SPACER
1	FTAS12	STICKER FT BLUE 10X4 DIE CUT
1	FTAS16	DRIVER WARNING DECAL
1	FTREGCARD	REGISTRATION CARD

FT50431 - HARDWARE KIT		LOCATION
4	1/2-13 X 4-1/2" HEX BOLT	
2	1/2-13 X 1-1/4" HEX BOLT	
4	1/2-13 X 1-3/4" HEX BOLT	
2	1/2-13 X 3-1/4" HEX BOLT	
2	1/2-13 X 2-3/4" HEX BOLT	
22	1/2" SAE WASHER G8	
6	1/2" LOCK WASHER G8	
8	1/2-13 C-LOCK NUT	
6	7/16-14 X 1" HEX BOLT	
6	7/16" SAE WASHER	
6	7/16" LOCK WASHER	
2	9/16-12 X 4-1/4" HEX BOLT	
4	9/16" SAE WASHER	
2	9/16-12 C-LOCK NUT	
1	THREAD LOCKING COMPOUND	

FTS24127 2.5" DLSS COILOVER 5" REAR		
2	FT820412	2.5 DLSS C/O W/ RESI
4	FT83077	URETHANE RESI MOUNT
2	FT86004	HARDWARE & BUSHING KIT 4
4	FT89026	#48 HOSE CLAMP
1	FT50430	HARDWARE SUBASSEMBLY



- TOOL LIST -

Required Tools (Not Included)

- Basic Hand Tools
- Torque Wrench
- Floor Jack
- Jack Stands
- Assorted Metric and S.A.E sockets, and Allen wrenches
- Die Grinder w/ Cutoff Wheel or Sawzall
- Drill and assorted drill bits

- PRE-INSTALLATION NOTES -

For technical assistance call: **909-597-7800** or e-mail: **info@fabtechmotorsports.com**

READ THIS BEFORE YOU BEGIN INSTALLATION -

Check all parts to the parts list above before beginning installation. If any parts are missing contact Fabtech at 909-597-7800 and a replacement part will be sent to you immediately.

Read all instructions thoroughly from start to finish before beginning the installation. If these instructions are not properly followed severe frame, driveline and / or suspension damage may occur.

Check your local city and state laws prior to the installation of this system for legality. Do not install if not legal in your area.

Prior to the installation of this suspension system perform a front end alignment and record. Do not install this system if the vehicle alignment is not within factory specifications. Check for frame and suspension damage prior to installation.

The installation of this suspension system should be performed by two professional mechanics.

This suspension must be installed with Fabtech shock absorbers.

Use the provided thread locking compound on all hardware.

WARNING- Installation of this system will alter the center of gravity of the vehicle and may increase roll over as compared to stock.

Vehicles that receive oversized tires should check ball joints, uniballs, tie rods ends, pitman arm and idler arm every 2500-5000 miles for wear and replace as needed.

Verify differential fluid is at manufactures recommended level prior to kit installation. Installation of the kit will reposition the differential and the fill plug hole may be in a different position. (For example, if the manufacture recommends 3 quarts of fluid, make sure the diff has 3 quarts of fluid). Check your specific manual for correct amount of fluid.

NOTE: Removal of the factory muffler is required to install this kit. Refer to the following MAGNAFLOW part numbers or a similar style aftermarket exhaust system to replace the factory exhaust.

-MAGNAFLOW #17143 4-DOOR

-MAGNAFLOW #17144 2-DOOR

FOOTNOTES -

- INSTRUCTIONS -

REAR SUSPENSION

1. Disconnect the negative terminal on the battery. Jack up the rear end of the truck and support the frame rails with jack stands. **NEVER WORK UNDER AN UNSUPPORTED VEHICLE!** Remove the rear tires.
2. Disconnect the brake lines and track bar from the frame. Remove the factory shocks, coil springs, isolators and sway bar. Save sway bar hardware.
3. Remove the factory cat-back exhaust along with the factory rubber exhaust hangers. **SEE FIGURE 1**

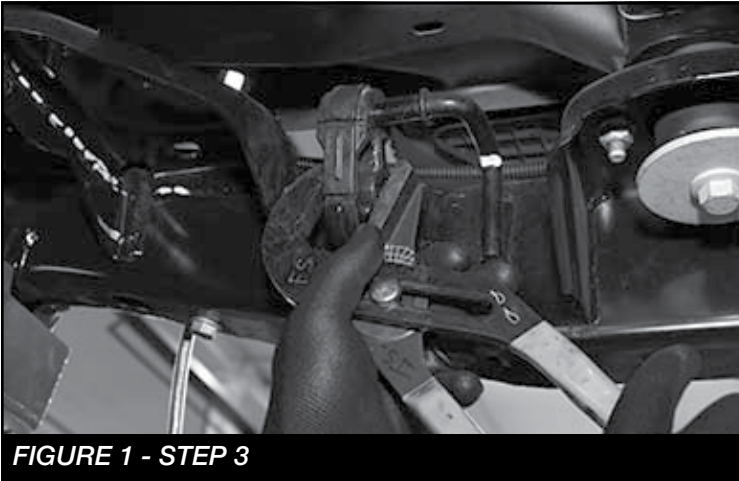

FIGURE 1 - STEP 3

4. Locate both driver and passenger upper shock mounts. Both mounts will need to be cut off from the frame. Mark and cut using a cut-off wheel. Sand and paint all bare metal areas. Trim 1" off of the factory gusset on both sides as well. **SEE FIGURES 2-5.**

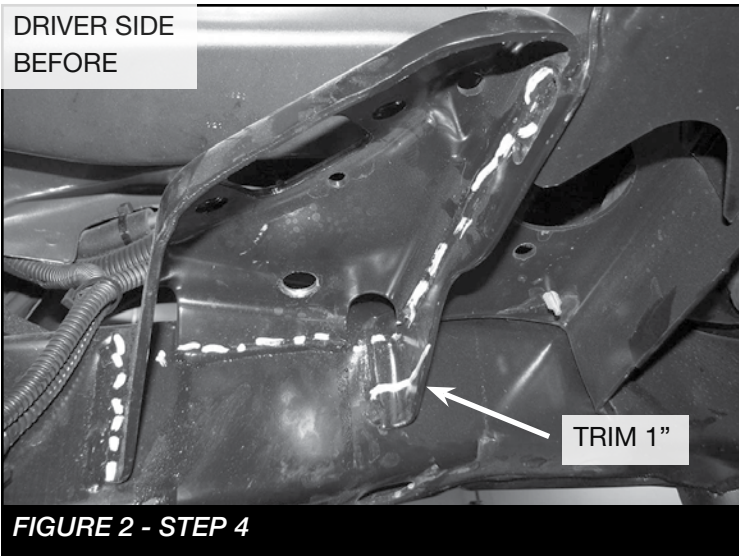

FIGURE 2 - STEP 4

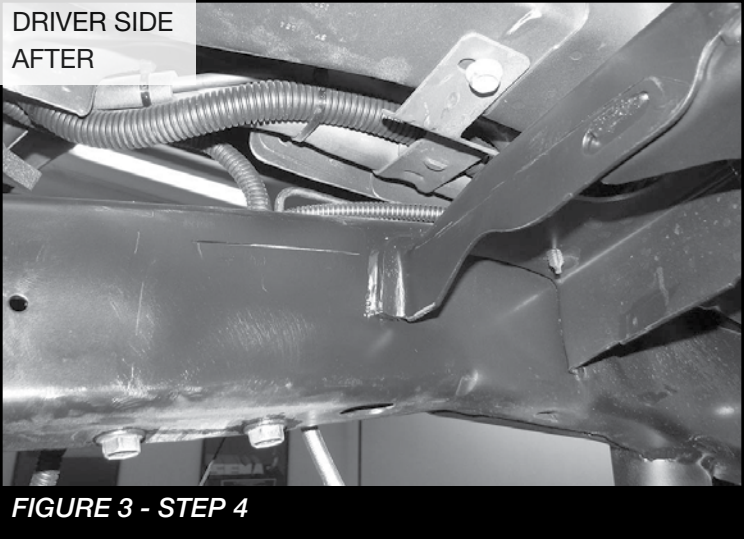

FIGURE 3 - STEP 4



FIGURE 4 - STEP 4

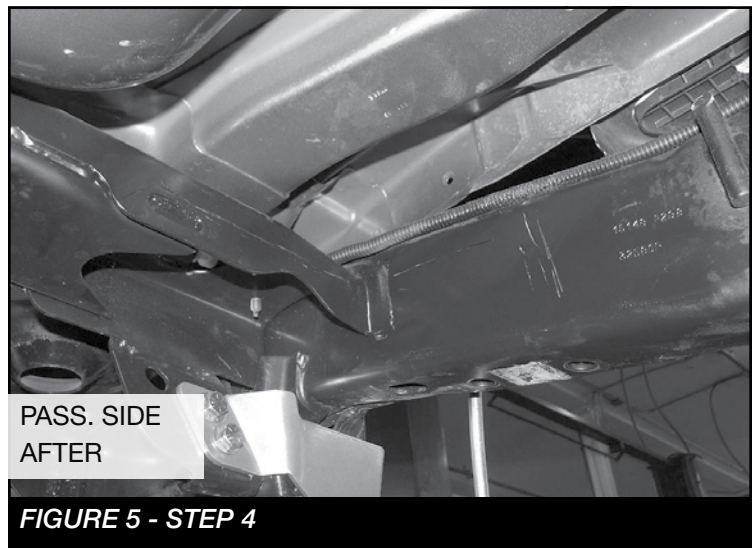

FIGURE 5 - STEP 4

- Cut both factory exhaust hangers off at the bend and re-route the passenger side wire harness from the inside of the frame to the outside. **SEE FIGURES 6-7**

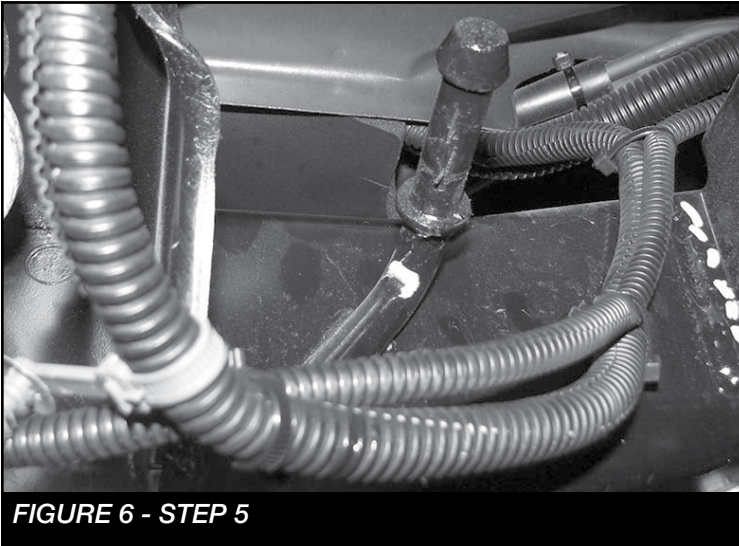

FIGURE 6 - STEP 5

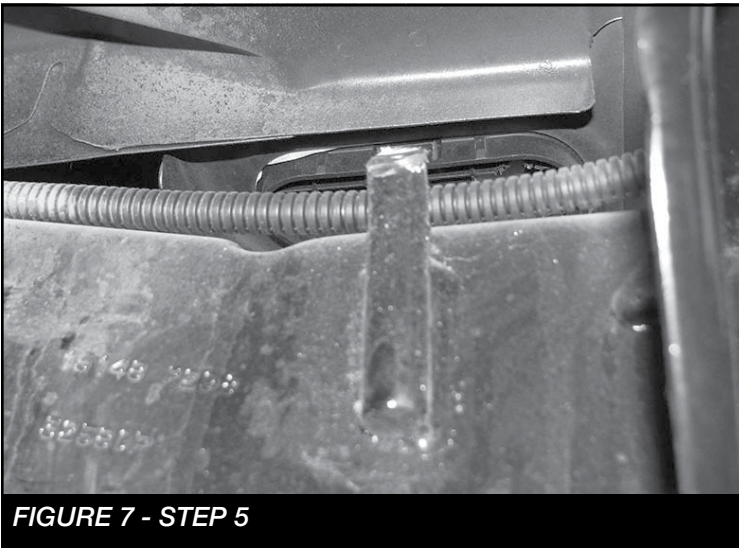

FIGURE 7 - STEP 5

- Remove the factory rear bumper and tow hook on the Drivers side. Set aside with hardware. This is required to install the new nut tab inside the frame rail. **NOTE: If equipped with factory tow hitch package, the hitch will need to be removed. If re-installing, the hitch will need to be slightly modified.**

- Using the help of another person, Install FT50426BK (Sub-Frame) using 2 factory bolts removed from the sway bar bracket attached to the frame and the 1/2" X 4-1/2" hardware. Install the factory bolt where the sway bar was attached. **SEE FIGURE 8.** Install the 1/2" hardware on the rear of the new sub-frame and through the frame. Leave hardware loose.

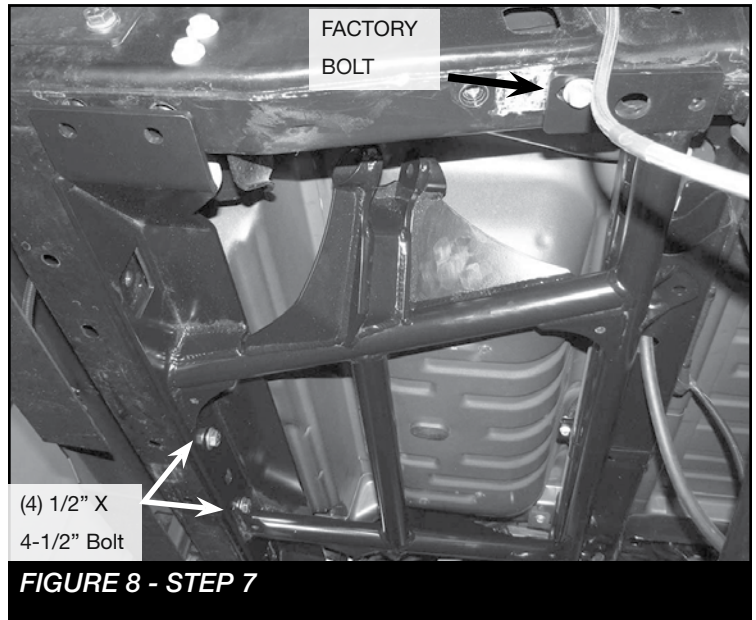

FIGURE 8 - STEP 7

- Locate FT50432 (Dual nut tab), (**NOTE: For factory bumpers and aftermarket that do not included new frame rails use FT50557 Spacers**) and 1/2" X 1-3/4" bolts, lock and standard washers. Insert the nut tab through the rear opening of the frame to line up with the factory holes on the Drivers side. **SEE FIGURE 9.** Install the 7/16" hardware at the rear sides of the sub-frame using the FT50557 (Spacers) between the vehicle frame and Fabtech sub-frame. **SEE FIGURE 10.**

- Passenger Side: Using the sub-frame as a guide, drill the (2) 1/2" holes into the frame and repeat step 8 on the Passenger side.

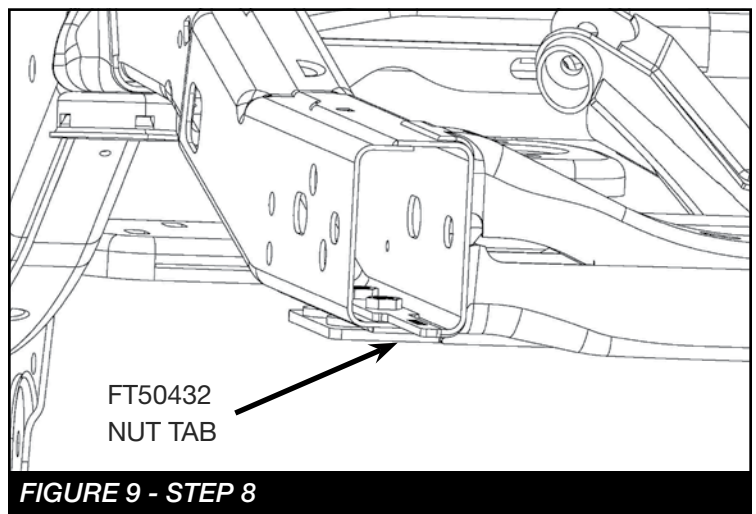

FIGURE 9 - STEP 8

FT50557
SPACER

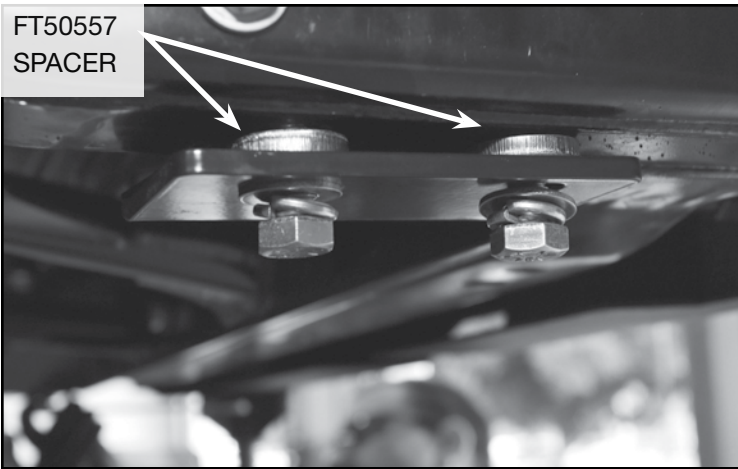

FIGURE 10 - STEP 8

9. Torque the factory hardware to 100 ft-lbs and 1/2" to 127 ft-lbs.
10. Locate the area where the sub-frame is mounted to the frame at the old sway bar location. The forward hole will need to be drilled out to 7/16". Repeat on Passenger side. **SEE FIGURE 11**

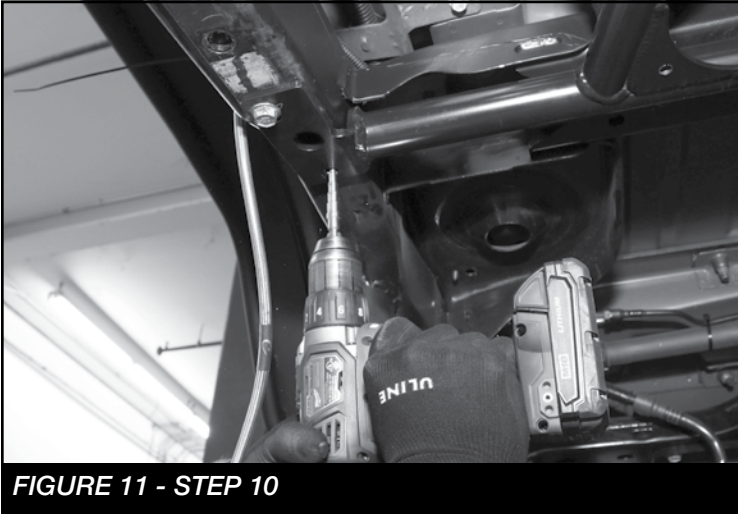

FIGURE 11 - STEP 10

11. Install FT50195 (Nut Tab) through the existing hole with the 7/16" x 1" Bolt, lock and standard washers. Torque to 83 ft-lbs.
12. Locate the front 2 mount tabs on the Fabtech Sub frame. Drill 1/2" holes through the frame using the new sub frame as a guide. **SEE FIGURE 12**



FIGURE 12 - STEP 12

13. Install FT30201 (Nut Tab) with 1/2" X 1-1/4" bolt, lock and standard washers. Torque to 127 ft-lbs. **SEE FIGURES 13-14**

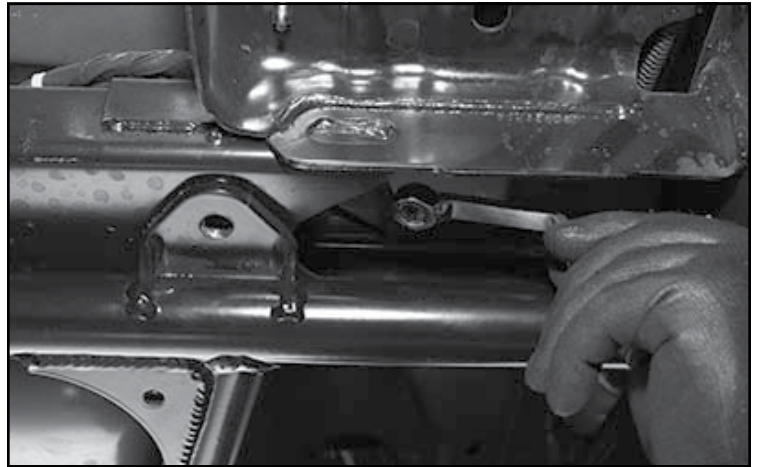

FIGURE 13 - STEP 13

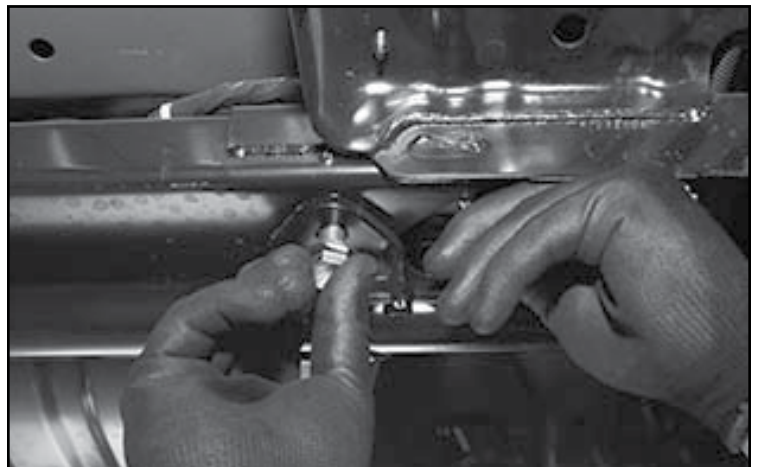

FIGURE 14 - STEP 13

- **AXLE BRACKET INSTALLATION**

- Using a reciprocating saw or cut off wheel. Cut off the factory lower shock mount and sway bar end link mount. Sand to a smooth finish. **SEE FIGURES 15-16**

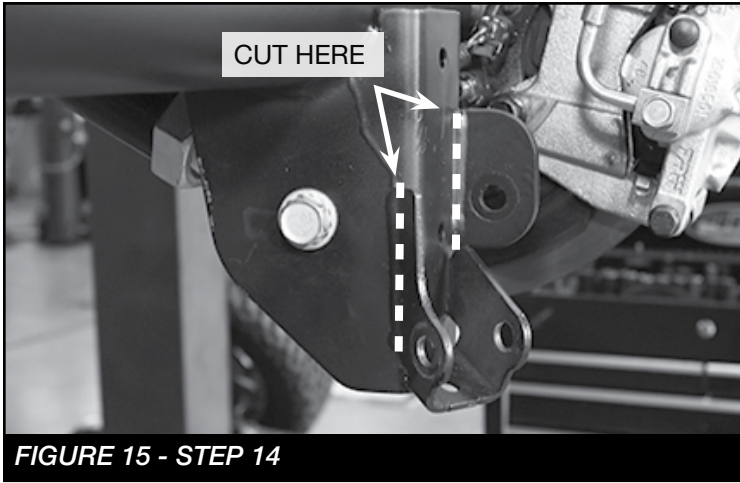

FIGURE 15 - STEP 14

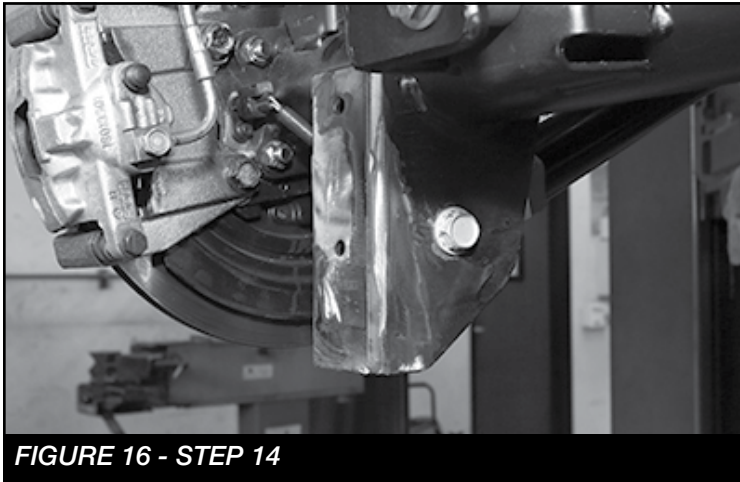

FIGURE 16 - STEP 14

- Measure 1.75" up from the bottom of the mount and mark a straight line across all sides. With the axle supported remove the lower link and cut where you made the mark. **SEE FIGURES 17-18**

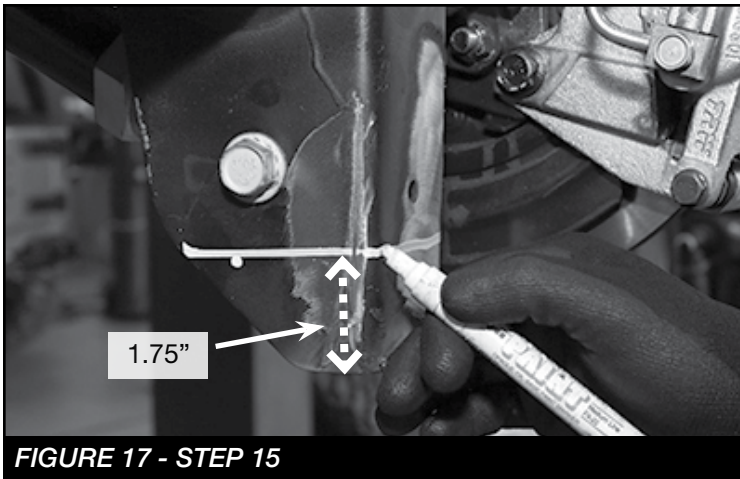

FIGURE 17 - STEP 15

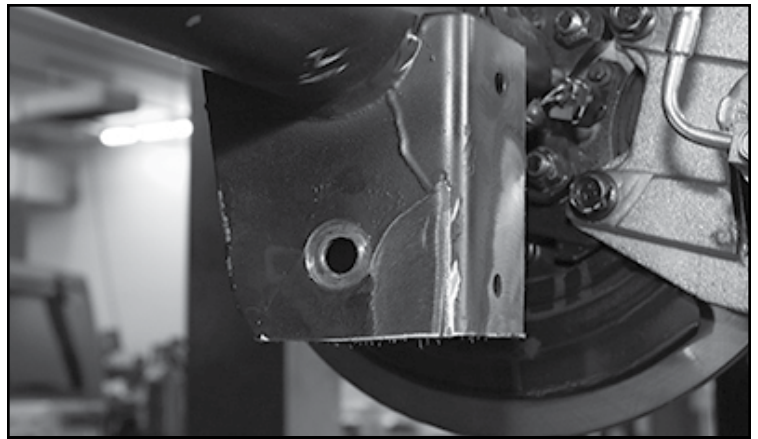

FIGURE 18 - STEP 15

- Test fit the Lower rear shock mount and make additional cuts if necessary. Sand and paint all bare metal areas. **SEE FIGURE 19**

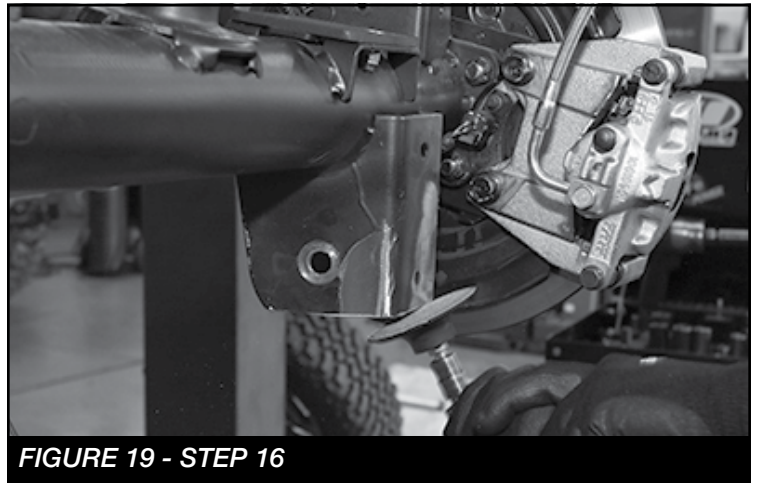

FIGURE 19 - STEP 16

- Install the lower rear shock mount and lower link using the 9/16-12 X 4-1/4" bolt and hardware. **SEE FIGURE 20**

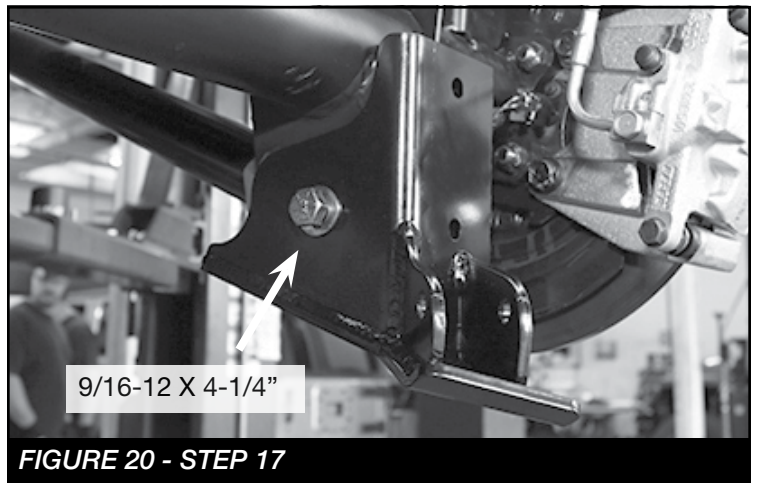

FIGURE 20 - STEP 17

18. Using a 7/16" drill bit. Drill out the (2) holes on the factory mount using the new Fabtech bracket as a guide. **SEE FIGURE 21**

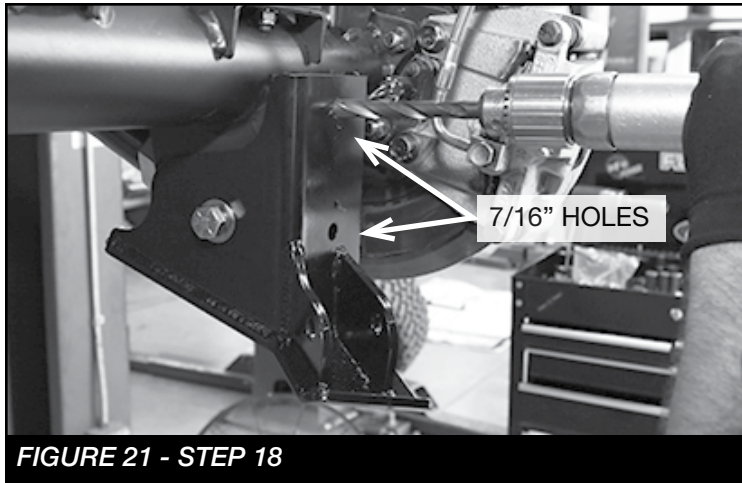

FIGURE 21 - STEP 18

19. Insert FT50327 (Dual nut tab) and install the supplied 7/16-14 X 1" bolts, lock and SAE washers. Torque 7/16" hardware to 83 ft-lbs, and 9/16" to 184 ft-lbs. **SEE FIGURES 22-23**

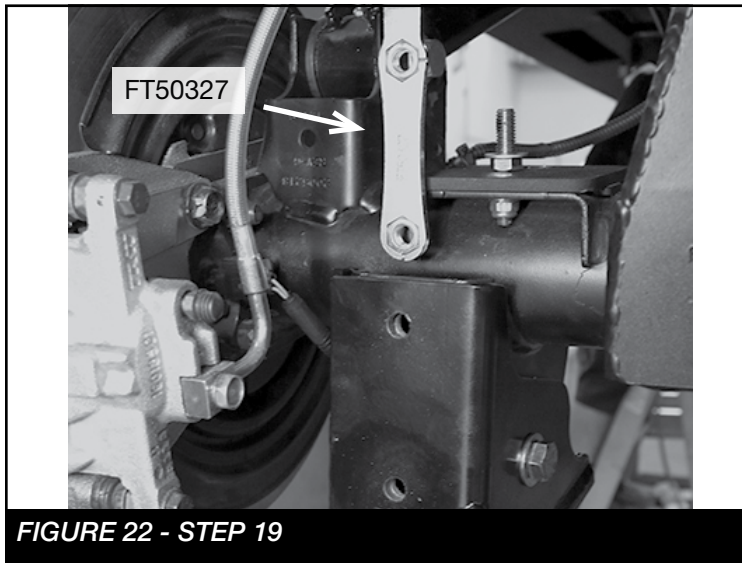

FIGURE 22 - STEP 19

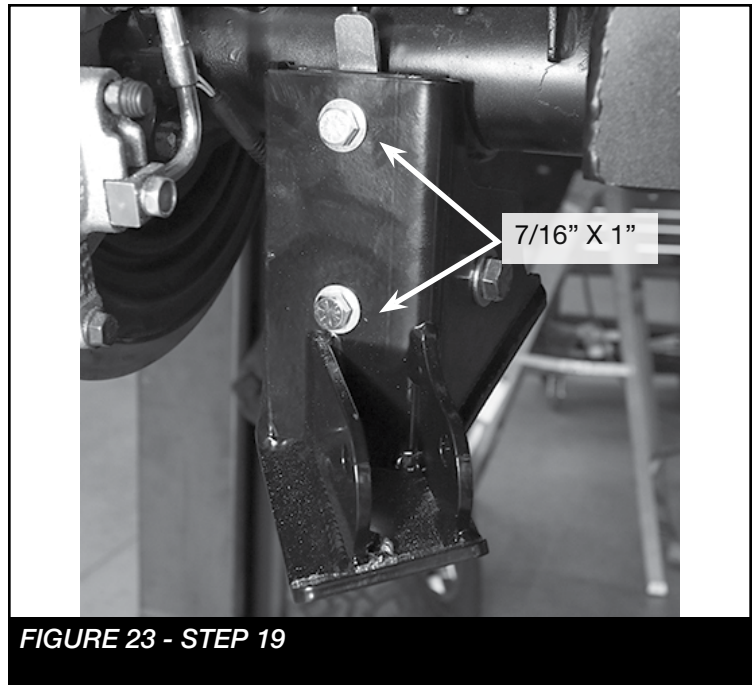

FIGURE 23 - STEP 19

20. Install the new FT820412 (Fabtech coilover) using the supplied misalignments and 1/2" x 3-1/4" bolt and hardware for the upper mount and 1/2" x 2-3/4" bolt and hardware for the lower mount. **NOTE: Install the coilover so the resi hose is oriented towards the front of the vehicle.** Torque to 127 ft-lbs. **SEE FIGURE 24**

- **REPEAT STEP 20 ON PASSENGER SIDE**

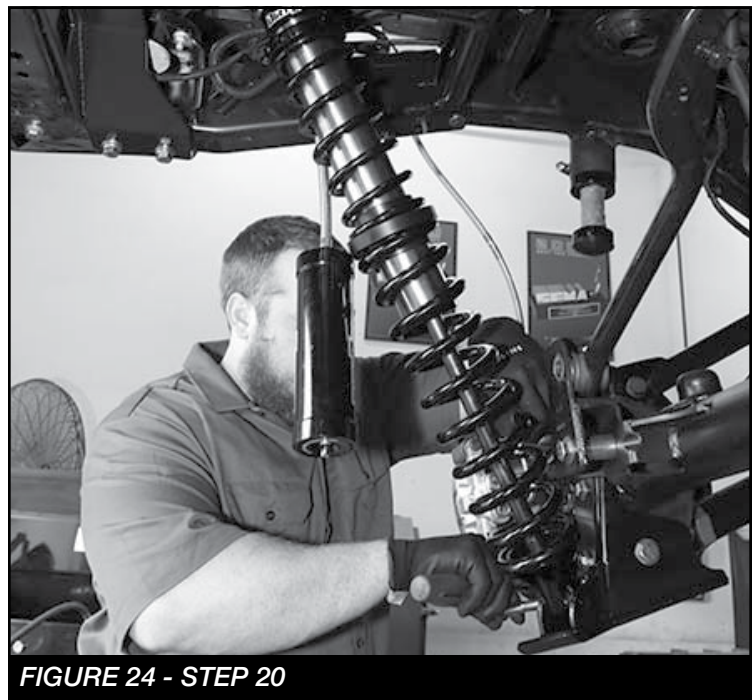

FIGURE 24 - STEP 20

21. Install the resi to the sub-frame using the supplied urethane bushings and hose clamp. **Leave loose. The skid plate has cut outs in which the clamps will in set once installed correctly. SEE FIGURES 25-26**



FIGURE 25 - STEP 21

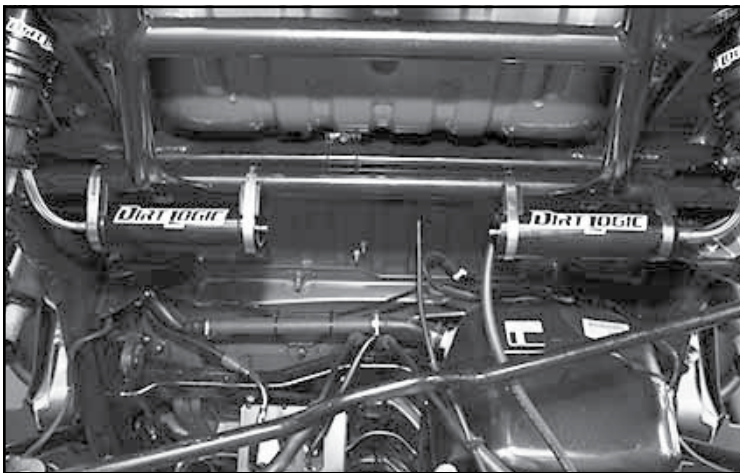

FIGURE 26 - STEP 21

22. Install FT50429BK (Skid Plate) using the supplied 7/16" x 1" bolts, lock and standard washers. **NOTE: Be sure the resi clamps are in set into the skid plate cutouts. Once clear, tighten clamps and torque 7/16" hardware to 83 ft-lbs. SEE FIGURE 27**

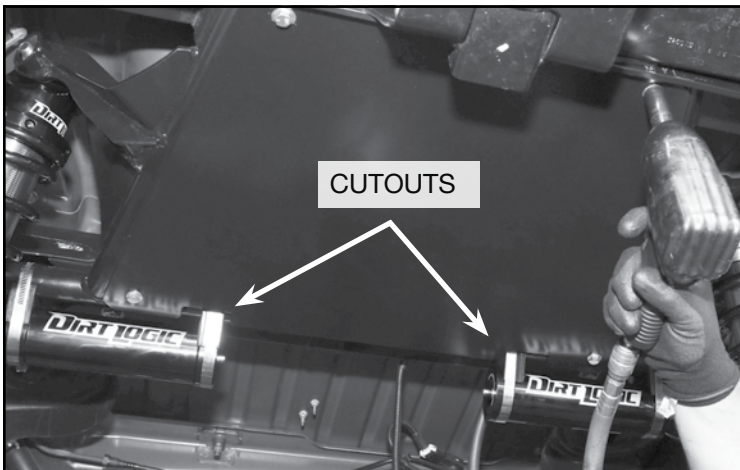

FIGURE 27 - STEP 22

23. Reconnect the track bar, brake lines and re-install the rear bumper. If installing aftermarket exhaust do so at this time.

24. See **FIGURE 28** for finished product.

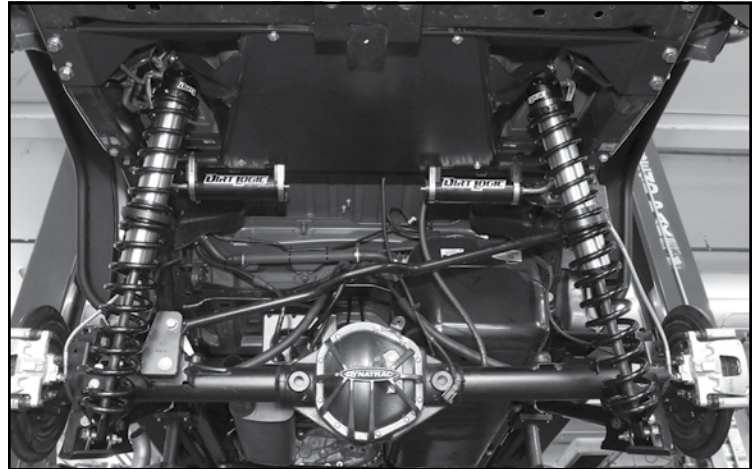

FIGURE 28 - STEP 24

25. Install tires and wheels and torque lug nuts to wheel manufacturer's specifications. **Note - Some oversized tires may require trimming of the front bumper & valance.**
26. Recheck all bolts for proper torque.
27. Recheck brake hoses, ABS wires and suspension parts for proper tire clearance while turning tires fully left to right.
28. Check the fluid in the front and rear differential and fill if needed with factory specification differential oil. **Note - some differentials may expel fluid after filling and driving. This can be normal in resetting the fluid level with the new position of the differential/s.**
29. Install Driver Warning Decal. Complete product registration card and mail to Fabtech in order to receive future safety and technical bulletins on this suspension.

Vehicles that will receive oversized tires should check ball joints, uniballs and all steering components every 2500-5000 miles for wear and replace as required.

RE-TORQUE ALL NUTS, BOLTS AND LUGS AFTER 50 MILES AND PERIODICALLY THEREAFTER.

For technical assistance call: **909-597-7800**

- Product Warranty and Warnings -

Fabtech provides a Limited Lifetime Warranty to the original retail purchaser who owns the vehicle, on which the product was originally installed, for defects in workmanship and materials.

The Limited Lifetime Warranty excludes the following Fabtech items; bushings, bump stops, ball joints, tie rod ends, limiting straps, cross shafts, heim joints and driveshafts. These parts are subject to wear and are not considered defective when worn. They are warranted for 60 days from the date of purchase for defects in workmanship.

Dirt Logic and Performance Coilover take apart shocks are considered a serviceable shock with a one year warranty on leakage only. Service seal kits are available separately for future maintenance. All other shocks are covered under our Limited Lifetime Warranty.

Fabtech does not warrant any product for finish, alterations, modifications and/or installation contrary to Fabtech's instructions. Alterations to the finish of the parts including but not limited to painting, powder coating, plating and/or welding will void all warranties. Some finish damage may occur to parts during shipping, which is considered normal and is not covered under warranty.

Fabtech products are not designed nor intended to be installed on vehicles used in race applications or for racing purposes or for similar activities. (A "RACE" is defined as any contest between two or more vehicles, or any contest of one or more vehicle against the clock, whether or not such contest is for a prize). This warranty does not include coverage for police or taxi vehicles, race vehicles, or vehicles used for government or commercial purposes. Also excluded from this warranty are sales outside of the United States of America.

Installation of most suspension products will raise the center of gravity of the vehicle and will cause the vehicle to handle differently than stock. It may increase the vehicle's susceptibility to a rollover, on road and off road, at all speeds. Extreme care should be taken to operate the vehicle safely at all times to prevent rollover or loss of control resulting in serious injury or death. Fabtech front end Desert Guards may impair the deployment or operation of vehicles equipped with supplemental restraining systems/air bag systems and should not be installed if the vehicle is equipped as so.

Fabtech makes every effort to ensure suspension product compatibility with all vehicles listed on the website, but due to unknown auto manufacturer's production changes and/or inconsistencies by the auto manufacturer, Fabtech cannot be responsible for 100% compatibility, including the fitment of tire and wheel sizes listed. The Tire and Wheel sizes listed in Fabtech's website are only a guideline for street driving with noted fender trimming. Fabtech is not responsible for damages to the vehicle's body or tires. Fabtech is not responsible for premature wear of factory components due to the installation of oversized tires and wheels.

Fabtech's obligation under this warranty is limited to the repair or replacement, at Fabtech option, of the defective product only. All costs of removal, installation or re-installation, freight charges, incidental or consequential damages are expressly excluded from this warranty. Fabtech is not responsible for damages and/or warranty of other vehicle parts related or non related to the installed Fabtech product. This warranty is expressly in lieu of all other warranties expressed or implied. This warranty shall not apply to any product that has been subject to accident, negligence, alteration, abuse or misuse as determined by Fabtech.

Fabtech suspension components must be installed as a complete system including shocks as shown on our website. All warranties will become void if Fabtech parts are combined and/or substituted with other aftermarket suspension products. Combination and/or substitution of other aftermarket suspension parts may cause premature wear and/or product failure resulting in an accident causing injury or death. Fabtech does not warrant products not manufactured by Fabtech.

Depending on the condition of the factory suspension components retained after the installation of a Fabtech suspension not all vehicles may have the same ride stance front to rear as described in the website. The blue color of suspension components shown in all Fabtech photographs are for display purposes only. Majority of all Fabtech components will be black specifically where noted with part numbers ending in BK.

Installation of Fabtech product may void the vehicles factory warranty; it is the consumer's responsibility to check with their local vehicle's dealer for warranty disposition before the installation of the product. Some state laws may prohibit modification of suspension to a vehicle in whole or in part. It is the responsibility of the installer and consumer to consult local laws prior to the installation of any Fabtech suspension product to comply with such written laws.

It is the responsibility of the distributor and/or the retailer to review all warranties and warnings of Fabtech products with the consumer prior to purchase.

Fabtech reserves the right to super cede, discontinue, change the design, finish, part number and/or application of parts when deemed necessary without written notice. Fabtech is not responsible for misprints or typographical errors within the website or price sheet. For the most recent Product Warranty and Warnings visit our website www.fabtechmotorsports.com