

Load **LIFTER** 7500 **XL**™



XL

Installation Guide

Kit 57595

Dodge/RAM Heavy Duty



Representative vehicle image

MN-1035 • (011612) • ERN 8634

For maximum effectiveness and safety, please read these instructions completely before proceeding with installation.

Failure to read these instructions can result in an incorrect installation.

LoadLIFTER7500XL

Table of Contents

| | |
|---|-----------|
| A. Introduction | 2 |
| Important Safety Notice | 2 |
| Notation Explanation | 2 |
| B. Installation Diagram | 3 |
| Hardware List | 3 |
| Tools List | 3 |
| C. Installing the LoadLifter 7500 XL System | 4 |
| Important System Information | 4 |
| Removing the Jounce Bumper and Installing the Frame Bracket | 4 |
| Assembling the Air Spring | 5 |
| Installing the Assemblies | 7 |
| D. Installing the Air Lines | 11 |
| Tips for Installing Air Lines | 13 |
| Installing the Heat Shield | 13 |
| E. Finished Installation Photos | 14 |
| F. Before Operating | 15 |
| Checking for Leaks | 15 |
| Fixing Leaks | 15 |
| Installation Checklist | 16 |
| Post-Installation Checklist | 16 |
| G. Product Use, Maintenance and Servicing | 17 |
| Minimum and Maximum Pressure | 17 |
| Maintenance Guidelines | 17 |
| Tuning the Air Pressure | 18 |
| Guidelines for Adding Air | 18 |
| H. Troubleshooting Guide | 19 |
| Frequently Asked Questions | 19 |
| Limited Warranty and Return Policy | 21 |
| Replacement Part Information | 21 |
| Contact Information | 21 |



A. Introduction

The purpose of this publication is to assist with the installation, maintenance and troubleshooting of the LoadLifter 7500 XL air spring kit. LoadLifter 7500 XL kits utilize sturdy, reinforced, commercial grade double convolute bellows. The bellows are manufactured like a tire with layers of rubber and cords that control growth. LoadLifter 7500 XL kits are recommended for most 3/4- and 1-ton pickups and SUVs with leaf springs and provide up to 7,500 pounds of load-leveling support with air adjustability from 5-100 PSI.

It is important to read and understand the entire installation guide before beginning installation or performing any maintenance, service or repair. The information here includes a hardware list, tool list, step-by-step installation information, maintenance guidelines and operating tips.

Air Lift Company reserves the right to make changes and improvements to its products and publications at any time. For the latest version of this manual, contact Air Lift Company at **(800) 248-0892** or visit **airliftcompany.com**.

IMPORTANT SAFETY NOTICE

The installation of this kit does not alter the gross vehicle weight rating (GVWR) or payload of the vehicle. Check your vehicle's owner's manual and do not exceed the maximum load listed for your vehicle.

Gross vehicle weight rating: The maximum allowable weight of the fully loaded vehicle (including passengers and cargo). This number — along with other weight limits, as well as tire, rim size and inflation pressure data — is shown on the vehicle's Safety Compliance Certification Label.

Payload: The combined, maximum allowable weight of cargo and passengers that the truck is designed to carry. Payload is GVWR minus the base curb weight.

NOTATION EXPLANATION

Hazard notations appear in various locations in this publication. Information which is highlighted by one of these notations must be observed to help minimize risk of personal injury or possible improper installation which may render the vehicle unsafe. Notes are used to help emphasize areas of procedural importance and provide helpful suggestions. The following definitions explain the use of these notations as they appear throughout this guide.



INDICATES IMMEDIATE HAZARDS WHICH WILL RESULT IN SEVERE PERSONAL INJURY OR DEATH.



INDICATES HAZARDS OR UNSAFE PRACTICES WHICH COULD RESULT IN SEVERE PERSONAL INJURY OR DEATH.



INDICATES HAZARDS OR UNSAFE PRACTICES WHICH COULD RESULT IN DAMAGE TO THE MACHINE OR MINOR PERSONAL INJURY.

NOTE

Indicates a procedure, practice or hint which is important to highlight.

B. Installation Diagram

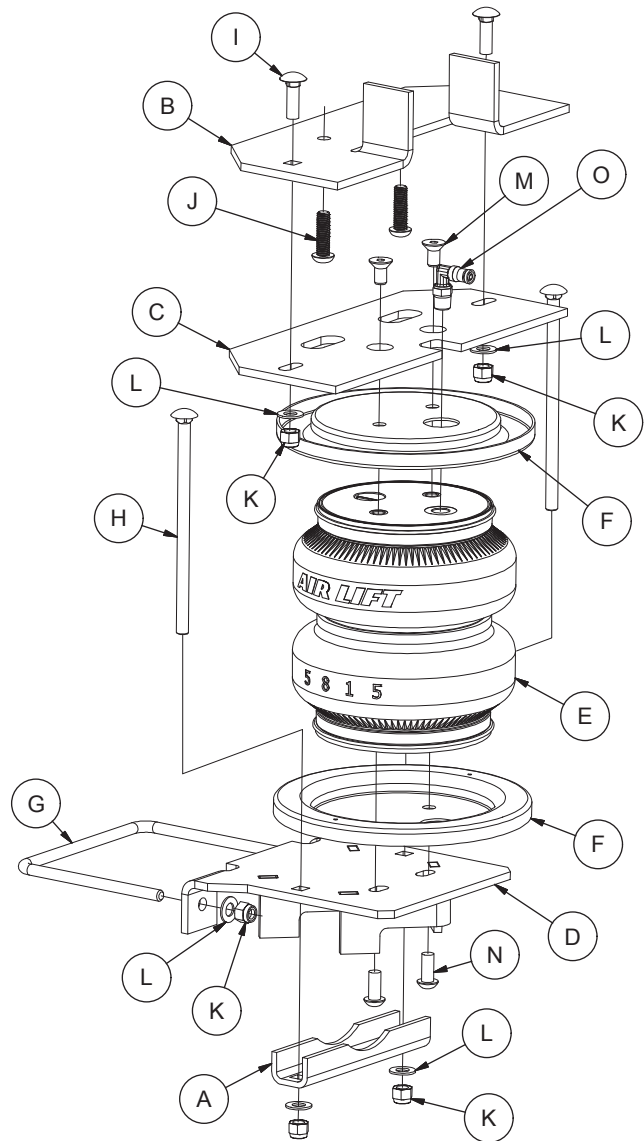
HARDWARE LIST

| Item | Part # | Description | Qty |
|------|--------|--|-----|
| A | 01531 | Clamp bar | 2 |
| B | 07407 | Upper bracket, frame..... | 2 |
| C | 07409 | Upper bracket, air spring | 2 |
| D | 03015 | Lower bracket..... | 2 |
| E | 58115 | Air spring..... | 2 |
| F | 11897 | Roll plate | 4 |
| G | 11717 | U-bolt | 2 |
| H | 17163 | 3/8"-16 x 7" Carriage bolt..... | 4 |
| I | 17361 | 3/8"-16 x 1.25" Carriage bolt..... | 4 |
| J | 17366 | M10-1.5 x 35 Button head cap screw ... | 4 |
| K | 18435 | 3/8"-16 Nylon lock nut..... | 12 |
| L | 18444 | 3/8" Flat washer..... | 12 |
| M | 17215 | 3/8"-24 x 7/8" Flat head cap screw | 4 |
| N | 17365 | 3/8"-24 x 7/8" Button head cap screw .. | 4 |
| O | 21830 | 90° Swivel elbow fitting..... | 2 |
| AA* | 20086 | Air line assembly | 1 |
| BB* | 10466 | Zip ties | 6 |
| CC* | 21230 | Valve caps | 2 |
| DD* | 18501 | 5/16" Flat washer..... | 2 |
| EE* | 21234 | Rubber flat washer..... | 2 |
| FF* | 18411 | Small star washer..... | 2 |
| GG* | 21233 | 5/16" Hex nut..... | 4 |

*Not shown in diagram

TOOLS LIST

| Description..... | Qty |
|---|-----|
| Metric & STD open-end box wrenches | set |
| Ratchet with metric and STD sockets..... | set |
| Drill and 5/16" drill bit..... | 1 |
| Torque wrench..... | 1 |
| Hex key wrenches metric and STD | set |
| Hose cutter, razor blade or sharp knife | 1 |
| Bench or hand grinder..... | 1 |
| Hoist or floor jack | 1 |
| Safety stands..... | 2 |
| Safety glasses | 1 |
| Air compressor or compressed air source | 1 |
| Spray bottle with dish soap/water solution..... | 1 |
| Black spray paint..... | 1 |



Missing or damaged parts? Call Air Lift customer service at (800) 248-0892 for a replacement part.

C. Installing the LoadLifter 7500 XL System

IMPORTANT SYSTEM INFORMATION

The air springs will last much longer if they are not the suspension limiter in either compression or extension. The air spring compresses to 3.3” and extends to 9.0”. Regardless of the load, the air pressure should be adjusted so that the normal ride height is maintained at all times. The shock absorber is usually the limiter on extension. If this is not the case, the use of limiting straps should be considered, particularly for off-road vehicles.

The vehicle may be equipped with a rear brake proportioning valve. Any type of load assist product could affect braking performance. Air Lift recommends that you check with your dealer before installing this type of product. If your vehicle DOES NOT have a rear brake proportioning valve or is equipped with an anti-lock type brake system, installation of a load assist product will have NO EFFECT on braking system performance.



COMPRESSED AIR CAN CAUSE INJURY AND DAMAGE TO THE VEHICLE AND PARTS IF IT IS NOT HANDLED PROPERLY. FOR YOUR SAFETY, DO NOT TRY TO INFLATE THE AIR SPRINGS UNTIL THEY HAVE BEEN PROPERLY SECURED TO THE VEHICLE.

REMOVING THE JOUNCE BUMPER AND INSTALLING THE FRAME BRACKET

1. Raise the vehicle and support it in a way, using jack stands or equivalent, that the axle can be safely dropped away from the frame. This will need to be done in order for the air spring assemblies to be put into position between the axle and frame (Fig. C.1).

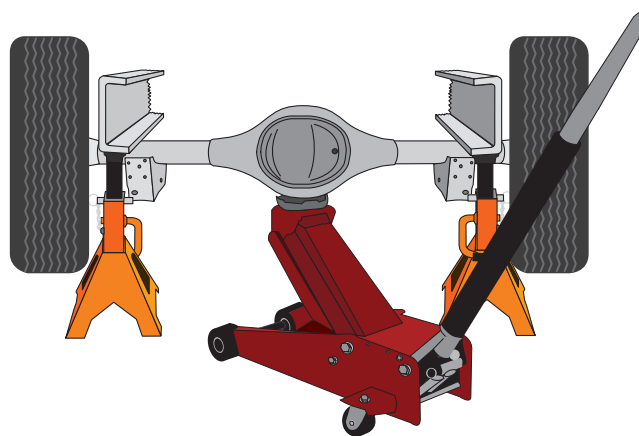


fig. C.1

- Unbolt and remove the jounce bumper from the jounce bumper bracket that is welded to the frame (Fig. C.2). Figure C.3 shows the jounce bumper removed.

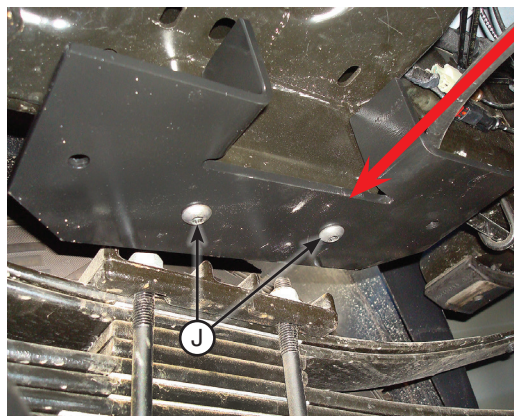


fig. C.2



fig. C.3

- Install the upper frame brackets (B) on both sides of the frame with two M10-1.5 x 35 button head cap screws (J) making sure the cutout in the brackets face inboard, away from the tire (Fig. C.4). Torque the hardware to 37 lb.-ft. (50Nm).



Cutout goes inboard on both sides of the truck.

fig. C.4

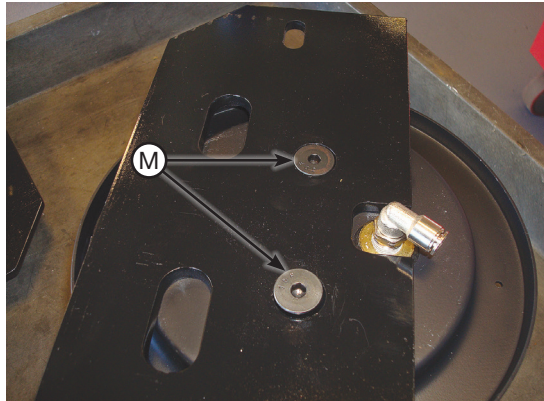
ASSEMBLING THE AIR SPRING

- Set a roll plate (F) on top of the air spring (E). The radiused, or rounded, edge of the roll plate will be toward the air spring so that it is seated inside the roll plate (Fig. C.5). Install the 90-degree swivel elbow fitting (O) into the top of the air spring, finger tight plus 1 1/2 turns.

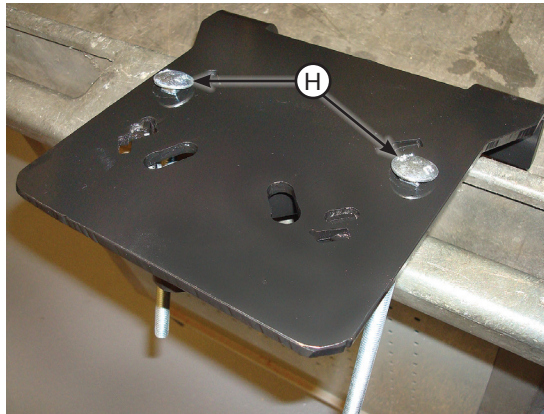


fig. C.5

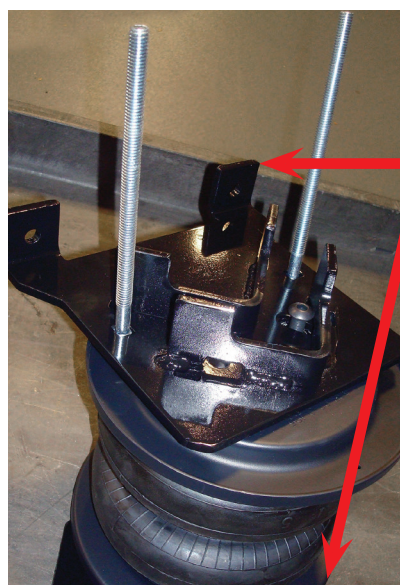
2. Install the upper air spring brackets (C) onto the air spring assemblies with the 3/8"-24 x 7/8" flat head cap screws (M) (Fig. C.6) and torque to no more than 20 lb.-ft. (27Nm).

*fig. C.6*

3. Insert two 3/8"-16 x 7" carriage bolts (H) into the square holes of both lower brackets (D) (Fig. C.7).

*fig. C.7*

4. Set a roll plate over the bottom of the air spring. Set the lower bracket with the carriage bolts installed, onto the air spring assembly so that the long flanges of the lower bracket are on the opposite side of the fitting at the top of the assemblies (Fig. C.8).



The flanges on the lower bracket must be on the opposite side of the fitting that is on the top of the air spring assemblies.

fig. C.8

5. Insert one 3/8"-24 x 7/8" (N) button head cap screw into one of the slots in the lower bracket and just start to thread it into the lower end cap (Fig C.9). The leg of the lower bracket has a cutout in it for the head of the screw to fit into. Lift up the lower bracket to create a gap between it and the air spring end cap and position the head of the screw under the leg of the bracket. Insert another screw into the remaining slot, position it under the leg of the bracket like the other one and by using a 7/32" hex head wrench, tighten both evenly until the lower bracket is tight to the air spring (C.10). Torque both to no more than 20 lb.-ft. (27Nm).

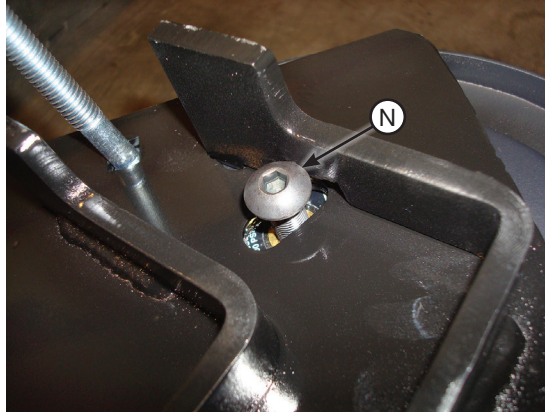


fig. C.9

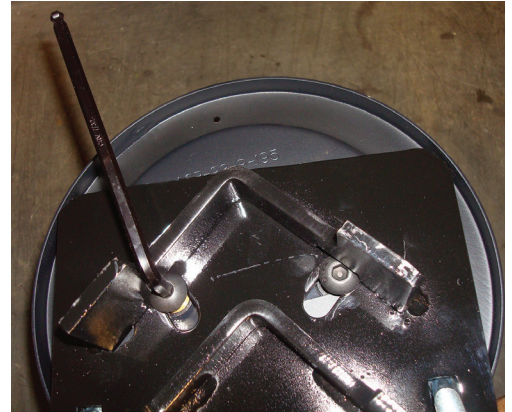


fig. C.10

NOTE

It may be necessary to hold the long carriage bolts in place while tightening these bolts.

6. Figure C.11 shows both assemblies ready for installation.



fig. C.11

INSTALLING THE ASSEMBLIES

1. Drop the axle down to make room for installing the assemblies.

NOTE

For the driver's side installation, there are two different ways to set the assembly on the axle based on the early- and late-model brake line installation. Please read the next two steps and review the photos to distinguish what style brake line and the way of the installation that pertains to your model.

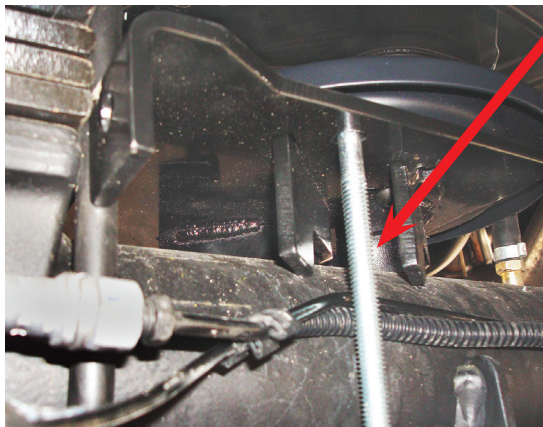
2. For the early-model trucks that have the hard brake line that is behind the axle and that is mounted away from the axle (has a gap between the axle and brake line), as you are setting the driver's side assembly into position, make sure the lower bracket carriage bolt that will be behind the axle is in between the brake line and the axle (Fig. C.12).



Carriage bolt must be between the hard brake line and axle for this model that has the brake line routed off the axle.

fig. C.12

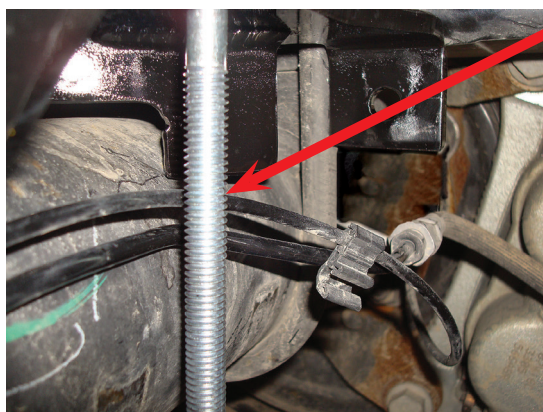
3. For the late-model trucks that have the hard brake line and possibly an ABS harness that is behind and mounted flush to the axle (has no gap between the axle and brake line), set the driver's side assembly into place make sure the carriage bolt goes on the outside of the brake line (Fig. C.13).



Carriage bolt must be on the outside of the hard brake line and axle for this model that has the brake line flush to the axle.

fig. C.13

4. On the passenger's side, the lower bracket carriage bolt is always on the outside of the brake line on all early and late model trucks (Fig. C.14).



The carriage bolt is always on the outside of the brake line on the passenger's side, regardless of the year.

fig. C.14

- On some models, the roll plate on the driver's (left) side may come in contact with the vent tube hose that comes out of the axle on the driver's side. It may be necessary to modify the roll plate by cutting or grinding a small section out to clear the hose. The lower bracket must sit flush on the axle with no axle vent tube interference (Figs. C.15a & C.15b). Spray paint any exposed metal from grinding or cutting the roll plate before the final installation of the assembly.

It may be necessary to modify the lower roll plate if it contacts the vent tube on the driver's side (left).

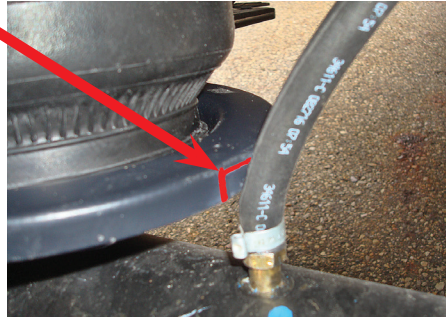


fig. C.15a

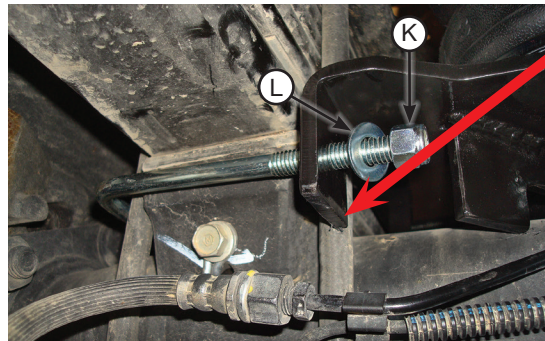


fig. C.15b

- Push the lower brackets up against the leaf spring pack so that the front and back legs are locked around the stock U-bolts. Set the U-bolt (G) supplied around the spring stack and through the legs of the lower bracket (Fig. C.16). Install the 3/8" flat washers (L) over the U-bolts and cap with the 3/8" nylon lock nuts (K). Draw the hardware (snug only, do not tighten yet) evenly, making sure that the lower bracket stays nested against the stock leaf spring pack and the legs are around the U-bolts.

NOTE

The lower bracket must be flush against the stock U-bolts.



Draw hardware evenly (snug only, do not tighten yet) making sure the lower bracket stays in position and locked around the U-bolts.

fig. C.16

- Install the clamp bar (A) over the long lower bracket carriage bolts under the axle and cap with the 3/8" flat washers (L) and 3/8" nylon lock nuts (K) (Fig. C.17). Tighten the hardware evenly and torque to 16 lb.-ft. (22Nm).



fig. C.17

- After torquing the lower clamp bar hardware, torque the leaf spring U-bolt that was previously installed and snugged to 10 lb.-ft. (14Nm).

9. Raise the axle or lower the frame until the air spring and frame brackets just touch. Insert the 3/8"-16 x 1.25" carriage bolts (I) down through the top frame brackets as shown (Fig. C.18) and cap with 3/8" flat washers (L) and 3/8"-16 nylon lock nuts (K). Leave loose at this time.

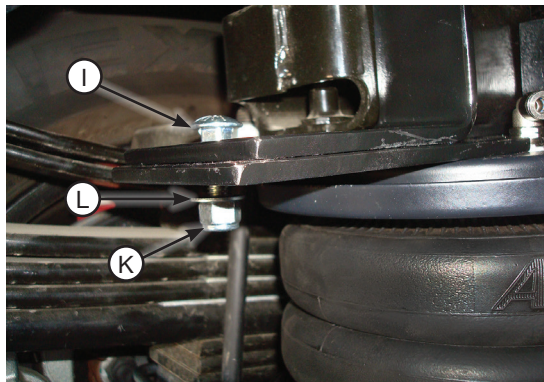


fig. C.18

10. Raise the axle or lower the frame so that the jack stands can be removed. Using the slot in the upper bracket, push the top of the air spring forward or backward to align the air spring so that it is perpendicular (as much as possible) to both the upper and lower brackets. Torque the upper bracket hardware to 31 lb.-ft. (42Nm) (Fig. C.19).



fig. C.19

NOTE

Once tight, the upper and lower brackets will not be parallel and may look like they are out of alignment. This condition is acceptable because of the way the lower bracket and upper bracket mounts are designed. Some variance from one unit to another is considered normal (Fig. C.20).

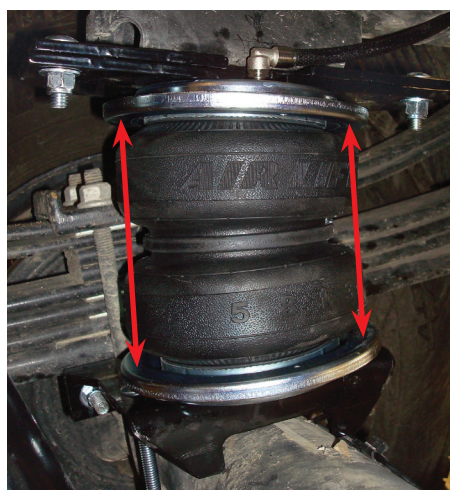
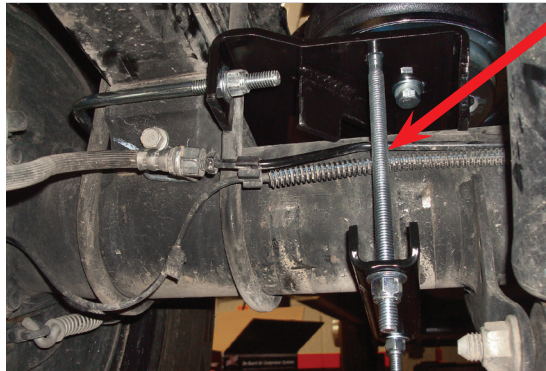


fig. C.20

 **CAUTION**

ONCE THE ASSEMBLIES ARE ADJUSTED AND TIGHT, MAKE SURE THE BRAKE LINES ON THE BACK (BOTH SIDES) DO NOT COME IN CONTACT WITH THE REAR CARRIAGE BOLTS. ADJUST BY PUSHING THE LINE OVER TO GAIN CLEARANCE IF NECESSARY (FIG. C.21).



Check driver's and passenger's sides to make sure the hard brake line is not rubbing on the carriage bolts. Adjust by pushing on the line to gain clearance if necessary.

fig. C.21

11. Make sure the emergency brake cable is above the upper brackets (Fig. C.22).



fig. C.22

D. Installing the Air Lines

This section explains how to set up the air spring kit to be controlled with Schrader valves and a separate compressed air source. An on-board air compressor system allows for hassle-free control of the air springs. Learn more about Air Lift control systems at www.airliftcompany.com/products/compressor-systems.

1. Before installing the passenger's side (right) air line, install the hose heat shield over the hose (Fig. D.1). Once the air line has been inserted into the fitting, align the heat shield so that it is protecting the air line from the exhaust pipe. Secure the air line to the frame with zip ties.



fig. D.1

2. Choose a convenient location for mounting the inflation valves. Popular locations for the inflation valve are:
 - a. The wheel well flanges
 - b. The license plate recess in bumper
 - c. Under the gas cap access door
 - d. Through the license plate

NOTE

Whatever the chosen location, make sure there is enough clearance around the inflation valves for an air chuck.

3. Drill 5/16" holes to install the inflation valves.
4. Cut the air line assembly in two equal lengths.
5. Place a 5/16" nut and star washer on the air valve. Leave enough of the inflation valve in front of the nut to extend through the hole and have room for the rubber washer, flat washer, and 5/16" nut and cap. There should be enough valve exposed after installation – approximately 1/2" – to easily apply a pressure gauge or an air chuck (Fig. D.2).

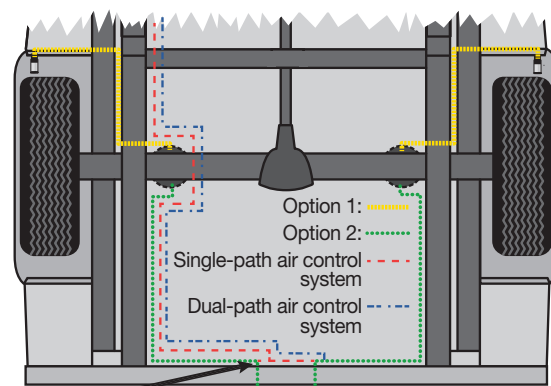


fig. D.2

If setting up a single-path system such as Wireless One or SmartAir II, use a T-fitting to connect the two sides. Dual-path systems such as Wireless Air have separate air lines to the air control system.

6. Push the inflation valve through the hole and use the rubber washer, flat washer, and another 5/16" nut to secure it in place. Tighten the nuts to secure the assembly.
7. Route the air line along the frame to the fitting on the air spring (Fig. D.3). Keep **AT LEAST 6"** of clearance between the air line and the exhaust system. Avoid sharp bends and edges. Use zip ties to secure the air line to fixed points along the chassis. Be sure that the tie straps are tight, but do not pinch the air line. Leave at least 2" of slack to allow for any movement that might pull on the air line.

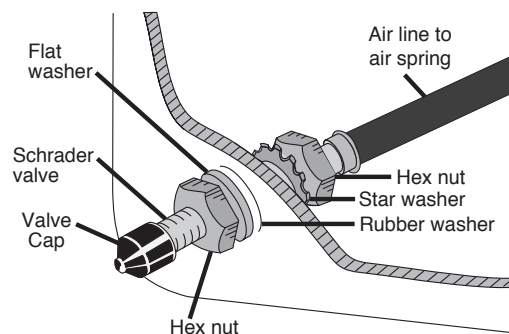


fig. D.3

- Cut off the air line, leaving approximately 12" of extra air line. A clean square cut will prevent leaks. Insert the air line into the air fitting. This is a push-to-connect fitting.

TECH TIP

Wiggle the hose back and forth while inserting to make sure the hose bottoms out in the fitting to obtain a good seal.

TIPS FOR INSTALLING AIR LINES

When cutting air lines, use a sharp knife or a hose cutter and make clean, square cuts (Fig. D.4). Do not use scissors or wire cutters because these tools may deform the air line, causing it to leak around fittings. Do not cut the lines at an angle.

Do not bend the 1/4" hose at a radius of less than 1" or bend the 3/8" hose at a radius of less than 1 1/2". Do not put side load pressure on fitting. The hose should be straight beyond the fitting for 1" before bending.

Inspect hose for scratches that run lengthwise on hose prior to installation. Contact Air Lift customer service at (800) 248-0892 if the air line is damaged.



To watch a video demonstrating proper air line cutting, go to air-lift.co/cuttingairline.

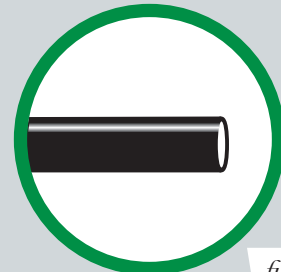


fig. D.4

**INSTALLING THE HEAT SHIELD**

- Bend tabs to provide a dead air space between exhaust pipe and heat shield. (Fig. D.5) Attach the heat shield to the exhaust pipe using the clamps. Bend the heat shield for maximum clearance to the air spring. Figure D.6 shows how it should look on this truck.

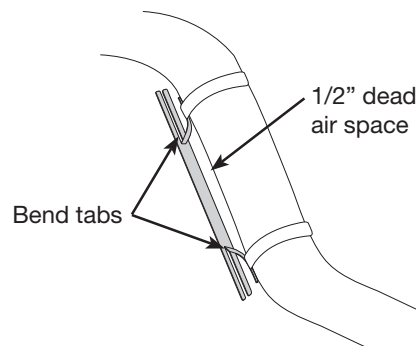


fig. D.5



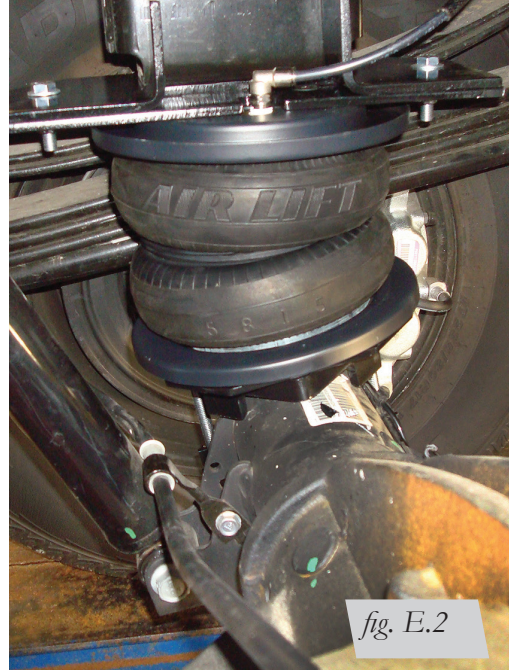
fig. D.6

E. Finished Installation Photos

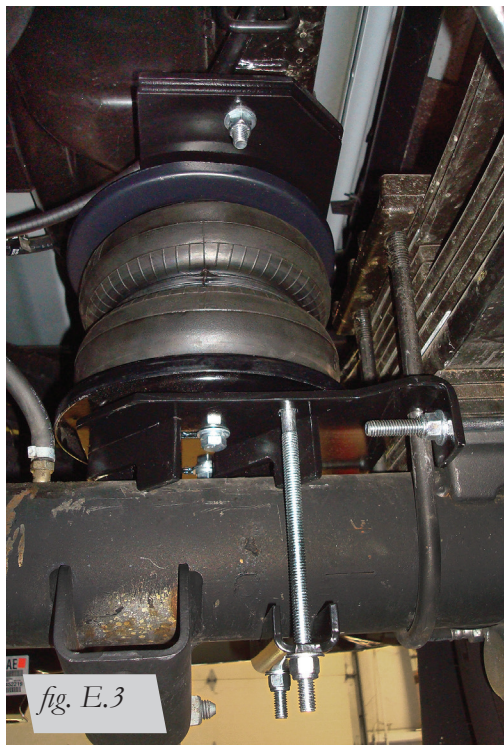
1. The following images show the finished installation of both sides (Figs. E.1, E.2, E.3 & E.4).



Back view of the driver's (left) side installation.



Inside view of the passenger's (right) side installation.



Forward view of the driver's side installation.



Forward view of the passenger's side installation.

F. Before Operating

CHECKING FOR LEAKS

1. Inflate the air spring to 30 PSI.
2. Spray all connections and the inflation valves with a solution of 1/5 liquid dish soap and 4/5 water. Spot leaks easily by looking for bubbles in the soapy water.
3. After the test, deflate the springs to the minimum pressure required to restore the system to normal ride height. Do not deflate to lower than 5 PSI.
4. Check the air pressure again after 24 hours. A 2-4 PSI loss after initial installation is normal. Retest for leaks if the loss is more than 5 PSI.

FIXING LEAKS

1. If there is a problem with the swivel fitting:
 - a. Check the air line connection by deflating the spring and removing the line by pulling the collar against the fitting and pulling firmly on the air line. Trim 1" off the end of the air line. Be sure the cut is clean and square (see Fig. D.4). Reinsert the air line into the push-to-connect fitting.
 - b. Check the threaded connection by tightening the swivel fitting another half turn. If it still leaks, deflate the air spring, remove the fitting, and re-coat the threads with thread sealant. Reinstall by hand tightening as much as possible and then use a wrench for an additional two turns.
2. If there is a problem with the inflation valve:
 - a. Check the valve core by tightening it with a valve core tool.
 - b. Check the air line by removing the air line from the barbed type fitting. Cut the air line off a few inches in front of the fitting and use a pair of pliers or vice grips to pull/twist the air line off of the fitting.



CAUTION

DO NOT CUT OFF THE AIR LINE COMPLETELY AS THIS WILL USUALLY NICK THE BARB AND RENDER THE FITTING USELESS.

3. If the preceding steps have not resolved the problem, call Air Lift customer service at **(800) 248-0892**.

INSTALLATION CHECKLIST

- Clearance test** — Inflate the air springs to 75-90 PSI and make sure there is at least 1/2" clearance from anything that might rub against each sleeve. Be sure to check the tire, brakes, frame, shock absorbers and brake cables.
- Leak test before road test** — Inflate the air springs to 75-90 PSI and check all connections for leaks. All leaks must be eliminated before the vehicle is road tested.
- Heat test** — Be sure there is sufficient clearance from heat sources, at least 6" for air springs and air lines. If a heat shield was included in the kit, install it. If there is no heat shield, but one is required, call Air Lift customer service at **(800) 248-0892**.
- Fastener test** — Recheck all bolts for proper torque.
- Road test** — The vehicle should be road tested after the preceding tests. Inflate the springs to recommended driving pressures. Drive the vehicle 10 miles and recheck for clearance, loose fasteners and air leaks.
- Operating instructions** — If professionally installed, the installer should review the operating instructions with the owner. Be sure to provide the owner with all of the paperwork that came with the kit.

POST-INSTALLATION CHECKLIST

- Overnight leak down test** — Recheck air pressure after the vehicle has been used for 24 hours. If the pressure has dropped more than 5 PSI, then there is a leak that must be fixed. Either fix the leak yourself or return to the installer for service.
- Air pressure requirements** — It is important to understand the air pressure requirements of the air spring system. Regardless of load, the air pressure should always be adjusted to maintain adequate ride height at all times while driving.
- Thirty-day or 500-mile test** — Recheck the air spring system after 30 days or 500 miles, whichever comes first. If any part shows signs of rubbing or abrasion, the source should be identified and moved, if possible. If it is not possible to relocate the cause of the abrasion, the air spring may need to be remounted. If professionally installed, the installer should be consulted. Check all fasteners for tightness.

G. Product Use, Maintenance and Servicing

| Minimum Recommended Pressure | Maximum Air Pressure |
|------------------------------|----------------------|
| 5 PSI | 100 PSI |

MAINTENANCE GUIDELINES

NOTE

By following the steps below, vehicle owners will obtain the longest life and best results from their air springs.

1. Check air pressure weekly.
2. Always maintain normal ride height. Never inflate beyond 100 PSI.
3. If you develop an air leak in the system, use a soapy water solution (1/5 liquid dish soap and 4/5 water) to check all air line connections and the inflation valve core before deflating and removing the air spring.



CAUTION

FOR SAFETY AND TO PREVENT POSSIBLE DAMAGE TO THE VEHICLE, DO NOT EXCEED MAXIMUM GROSS VEHICLE WEIGHT RATING (GVWR), AS INDICATED BY THE VEHICLE MANUFACTURER. ALTHOUGH THE AIR SPRINGS ARE RATED AT A MAXIMUM INFLATION PRESSURE OF 100 PSI, THE AIR PRESSURE ACTUALLY NEEDED IS DEPENDENT ON LOAD AND GVWR.

4. Loaded vehicles require at least 25 PSI. A “loaded vehicle” refers to a vehicle with a heavy bed load, a trailer or both. Never exceed GVWR, regardless of air spring, air pressure or other load assist. The springs in this kit will support approximately 40 pounds of load (combined on both springs) for each 1 PSI of pressure. The required air pressure will vary depending on the state of the original suspension. Operating the vehicle below the minimum air spring pressure will void the Air Lift warranty.
5. When increasing load, always adjust air pressure to maintain normal ride height. Increase or decrease pressure from the system as necessary to attain normal ride height for optimal ride and handling. Remember that loads carried behind the axle (including tongue loads) require more leveling force (pressure) than those carried directly over the axle.
6. Always add air to springs in small quantities, checking the pressure frequently.
7. Should it become necessary to raise the vehicle by the frame, make sure the system is at minimum pressure (5 PSI) to reduce the tension on the suspension/ brake components. Use of on-board leveling systems do not require deflation or disconnection.
8. Periodically check the air spring system fasteners for tightness. Also, check the air springs for any signs of rubbing. Realign if necessary.
9. On occasion, give the air springs a hard spray with a garden hose to remove mud, sand, gravel or other debris.

TUNING THE AIR PRESSURE

Pressure determination comes down to three things — level vehicle, ride comfort and stability.

1. Level vehicle

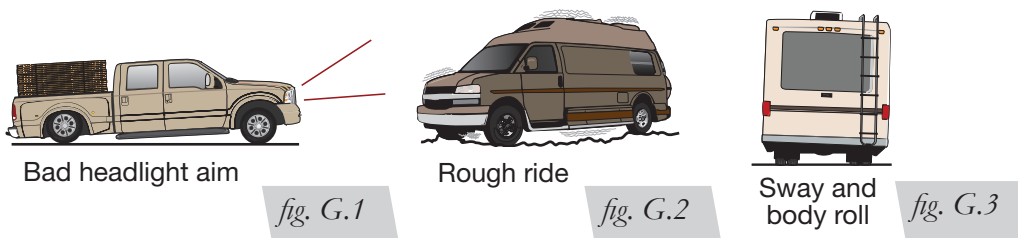
If the vehicle's headlights are shining into the trees or the vehicle is leaning to one side, then it is not level (Fig. G.1). Raise the air pressure to correct either of these problems and level the vehicle.

2. Ride comfort

If the vehicle has a rough or harsh ride it may be due to either too much pressure or not enough (Fig. G.2). Try different pressures to determine the best ride comfort.

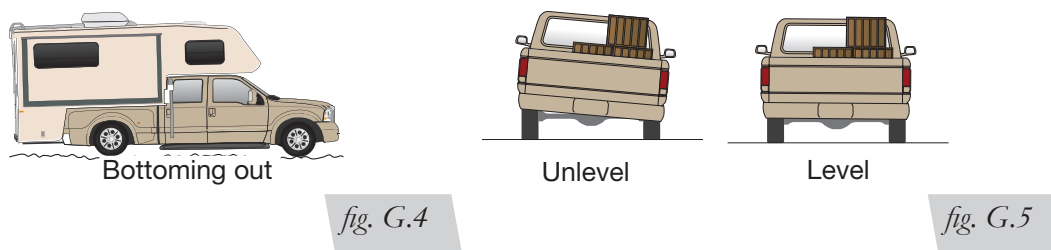
3. Stability

Stability translates into safety and should be the priority, meaning the driver may need to sacrifice a perfectly level and comfortable ride. Stability issues include roll control, bounce, dive during braking and sponginess (Fig. G.3). Tuning out these problems usually requires an increase in pressure.



GUIDELINES FOR ADDING AIR

1. Start with the vehicle level or slightly above.
2. When in doubt, always add air.
3. If the front of the vehicle dives while braking, increase the pressure in the front air bags, if equipped.
4. If it is ever suspected that the air bags have bottomed out, increase the pressure (Fig. G.4).
5. Adjust the pressure up and down to find the best ride.
6. If the vehicle rocks and rolls, adjust the air pressure to reduce movement.
7. It may be necessary to maintain different pressures on each side of the vehicle. Loads such as water, fuel, and appliances will cause the vehicle to be heavier on one side (Fig. G.5). As much as a 50 PSI difference is not uncommon.



H. Troubleshooting Guide

| PROBLEM | CAUSE | SOLUTION |
|---|--|--|
| System won't maintain pressure overnight. | Improperly installed air line, air line has holes or cracks. | Leak test the air line connections, the threaded connection into the air spring, and all fittings in the control system. |
| Air spring or air line leak. | Fitting seal or air line is compromised. | Check to make sure air lines are seated in connectors. Inspect fittings with soapy water. Trim hose or re-seal fitting. Ensure lines are cut straight. |
| Corner won't raise or air leak develops. | Look for a kink or fold in the air line. | Replace any air line that has been kinked. |

Notes

Limited Warranty and Return Policy

Air Lift Company provides a limited lifetime warranty to the original purchaser of its Load Support products, that the products will be free from defects in workmanship and materials when used on cars and trucks as specified by Air Lift Company and under normal operating conditions, subject to the requirements and exclusions set forth in the full Limited Warranty and Return Policy that is available online at www.airliftcompany.com/warranty.

For additional warranty information contact Air Lift Company customer service.

Replacement Part Information

If replacement parts are needed, contact the local dealer or call Air Lift customer service at **(800) 248-0892**. Most parts are immediately available and can be shipped the same day.

Contact Air Lift Company customer service at (800) 248-0892 first if:

- Parts are missing from the kit.
- Need technical assistance on installation or operation.
- Broken or defective parts in the kit.
- Wrong parts in the kit.
- Have a warranty claim or question.

Contact the retailer where the kit was purchased:

- If it is necessary to return or exchange the kit for any reason.
- If there is a problem with shipping if shipped from the retailer.
- If there is a problem with the price.

Contact Information

| | |
|---|--|
| Mailing address | P.O. Box 80167 Lansing, MI 48908-0167 |
| Shipping address for returns | 2727 Snow Road Lansing, MI 48917 |
| Phone | Toll free: (800) 248-0892 International: (517) 322-2144 |
| Email | service@airliftcompany.com |
| Web address | www.airliftcompany.com |

Need Help?

Contact Air Lift Company customer service department by calling (800) 248-0892. For calls from outside the USA or Canada, dial (517) 322-2144.



Thank you for purchasing Air Lift products — the professional installer's choice!

Air Lift Company • 2727 Snow Road • Lansing, MI 48917 or P.O. Box 80167 • Lansing, MI 48908-0167
Toll Free (800) 248-0892 • Local (517) 322-2144 • Fax (517) 322-0240 • www.airliftcompany.com

Printed in the USA
JJC-0118