



INSTALLATION INSTRUCTIONS

MAKE: Nissan
MODEL: Titan
YEAR: 2016-2019
ENGINE: V8-5.6L

WHEELBASE: (139.8") Standard Cab/Long Bed w/ 8 ft. Bed; (139.8") King Cab/
Long Bed w/ 6.6 ft. Bed; (139.8") Crew Cab/Standard Bed w/ 5.6 ft. Bed

2.5" to 3.5" Cat-Back
49-46125-B (Black Tip)
49-46125-P (Polished Tip)

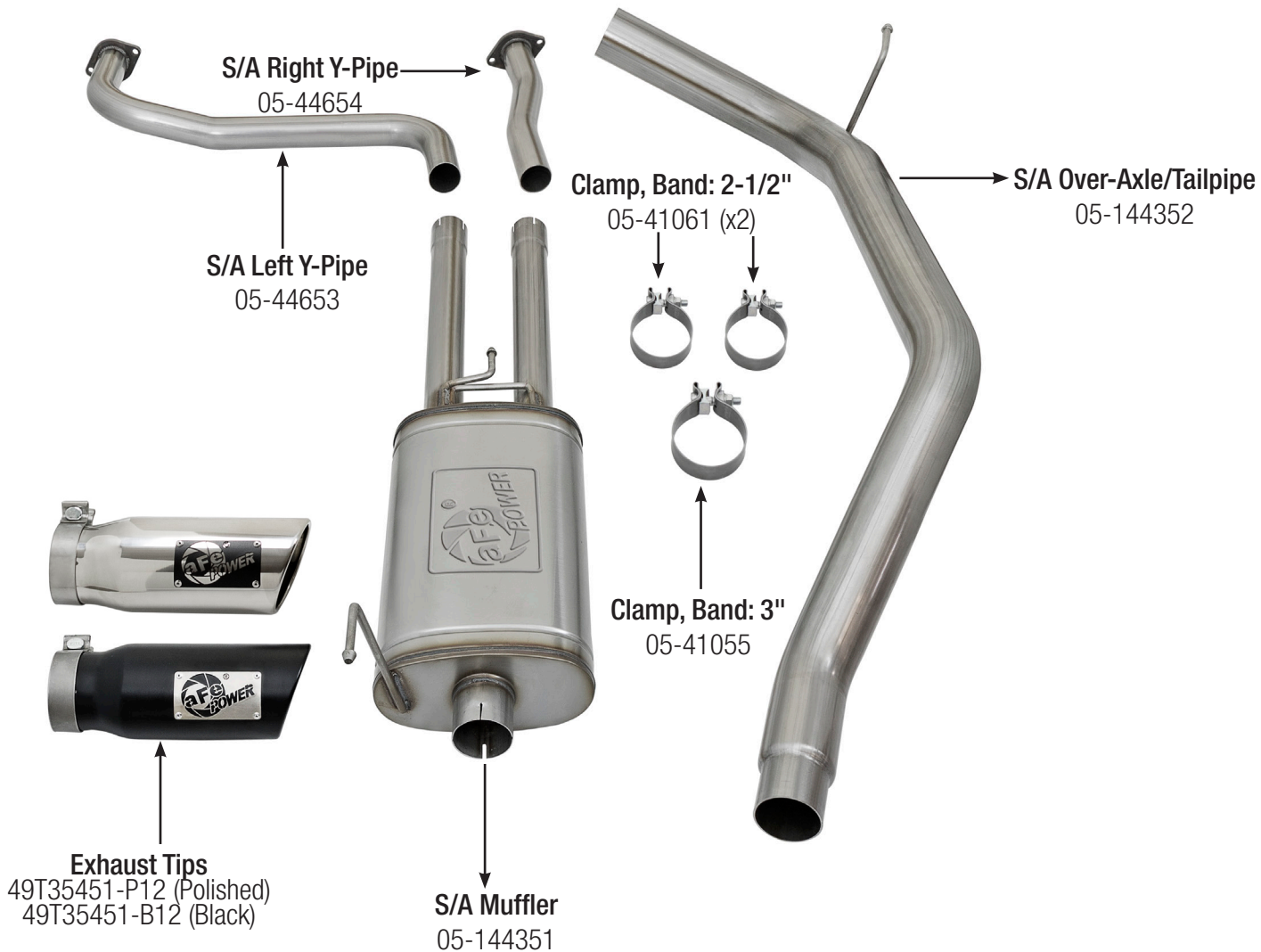

- Step 1:** (Read Instructions prior to installation) Remove your stock exhaust up to the catalytic converter from the rear of your truck working your way forward. Take caution not to damage the factory hardware and isolation mounts as they will be reused. It is recommended to not fully tighten the clamps until the entire system has been installed.
- Step 2:** For faster installation spread the pieces of the exhaust along side of your vehicle according to the diagram shown.
- Step 3:** Remove factory isolation mount brackets from vehicles frame to remove exhaust, once exhaust is removed transfer the isolation mounts back to the factory position.
- Step 4:** Install mid-pipes using factory bolts at flanges. Do not over tighten, now slip band clamps over the ends of the Muffler Assembly and slide on to the mid-pipes.
- Step 5:** Utilizing the factory isolation mounts now install over-axle/tailpipe and tip. Adjust the system to desired position and tighten all band clamps.
- Step 6:** Your installation is now complete. It is recommended to re-tighten all exhaust components after 50-100 miles.

NOTES:

- aFe recommends that the tailpipe be at least 1/2"-1" away from any body panels to avoid heat related body damage. **Tighten and secure.**

Caution: Allow time for your vehicle to cool down prior to installation. When working on or under your vehicle proceed with caution. Exhaust systems reach high temperatures and may cause serious burns. Wear protective safety equipment; eye goggles and gloves to ensure a safe installation. **aFe recommends professional installation on our products.**