



300 HUEY LENARD LOOP | WEST MONROE | LA 71292
 OFFICE: 318-397-3000 | FAX: 318-397-3040
 SERVICE & TECH SUPPORT: 800-551-4955
 SUPERLIFT.COM



2005-2019 Toyota Tacoma 2WD|4WD 2.00 Inch Leveling Kit INSTALLATION INSTRUCTIONS

Engineered for Both 2WD & 4WD Models.

- Fits:** 2005-2015 Toyota Tacoma
 2005-2015 Toyota Tacoma Pre Runner
 2005-2013 Toyota Tacoma X-Runner
 2016-2019 Toyota Tacoma Limited
 2016-2019 Toyota Tacoma SR
 2016-2019 Toyota Tacoma SR5

⚠️ NOTE: NOT Engineered for the T/X BAJA, XSP-X nor TRD PRO Models.

🚫 CAUTION: MAKE SURE YOU HAVE THE CORRECT LIFT FOR YOUR VEHICLE:
 Double check the Year, Make, Model, Lift Height and KIT Part Numbers.

⚠️ NOTE: Prior to beginning the installation, OPEN the Boxes and CHECK the Included Components Compared to the Parts Breakdown. Check all parts and hardware in the box with the parts list below. Be sure you have all needed parts and know where they install.

IF you find a packaging error, contact SUPERLIFT directly. Do not contact the dealer where the system was originally purchased. You will need the control number from each box when calling; this number is located at the bottom of the part number label and to the right of the bar code.

How to Read the Kit Breakdown Charts:

The 'K KIT BREAKDOWN' lists the Part Numbers, Quantities & Part Description of the Boxes that are included in the K KIT. The 'KIT BREAKDOWN' lists Part Numbers, Quantities & Part Description of the Individual Components & Hardware Bags that are included in Each Box. The 'HARDWARE BREAKDOWN' lists the Part Numbers, Quantities & Part Description of the Individual Components.



K KIT BREAKDOWN		
Kit Part Number	40046	
Part Number	Qty.	Part Description
40045	1	Kit Box - Front Leveling Kit, 2.00 Inch
KIT BREAKDOWN		
Kit Part Number	40046	
Part Number	Qty.	Part Description
55-01-40046	2	Front Strut Spacer, Aluminum
77-40046	1	Hardware Bag
KIT BREAKDOWN		
Kit Part Number	77-40046	
Part Number	Qty.	Part Description
	6	10mm Flat Washer
	6	10mm Lock Washer
	6	10mm Nut



300 HUEY LENARD LOOP | WEST MONROE | LA 71292
 OFFICE: 318-397-3000 | FAX: 318-397-3040
 SERVICE & TECH SUPPORT: 800-551-4955
 SUPERLIFT.COM



2005-2019 Toyota Tacoma 2WD|4WD 2.00 Inch Leveling Kit INSTALLATION INSTRUCTIONS

**THANK YOU FOR CHOOSING
 SUPERLIFT FOR ALL
 YOUR SUSPENSION NEEDS!**

CAUTION: Read And Understand All Instructions
 And Warnings Prior To Installation Of System AND
 Operation Of Vehicle.

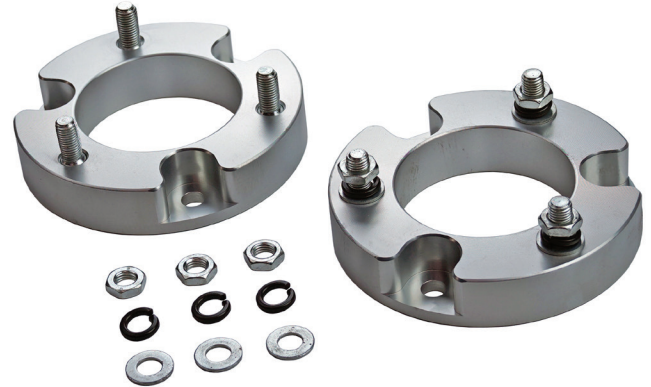

INTRODUCTION BEFORE INSTALLATION...

Installation requires a professional mechanic. In addition to these instructions, professional knowledge of disassembly / reassembly procedures and post installation checks must be known.

PRIOR to beginning, inspect the vehicles steering, driveline, and brake systems, paying close attention to the suspension link arms and bushings, sway bars and bushings, tie rod ends, pitman arm, idler arm, ball joints and wheel bearings. Also check the steering sector-to-frame and all suspension-to-frame attaching points for stress cracks. The overall vehicle must be in excellent working condition; repair or replace all worn parts.

Read instructions several times before starting.

Read each step completely as you go.

Be sure you have all needed parts and know where they install.

NOTES:

- Do NOT install this suspension system in conjunction with any other type of aftermarket or fabricated components to gain additional suspension height.
- Front end alignment is necessary.
- Tool and Wrench/Socket size is given in brackets [] after each appropriate step.
- A foot-pound torque reading is given in parenthesis () after each appropriate fastener.
- Prior to attaching components, be sure all mating surfaces are free of grit, grease, excessive undercoating, etc.
- Always wear safety glasses when using power tools.
- A factory service manual should be on hand for reference.

BEFORE YOU DRIVE...

Check all fasteners for proper torque. Check to ensure for adequate clearance between all rotating, mobile, fixed, and heated members. Verify clearance between exhaust and brake lines, fuel lines, fuel tank, floor boards and wiring harness. Check steering components for clearance.

Test and inspect brake system. Perform steering sweep to ensure front brake hoses have adequate slack and do not contact any rotating, mobile or heated members. Inspect rear brake hoses at full extension for adequate slack. Failure to perform hose check/replacement may result in component failure.

Perform head light check and adjustment.

⚠️ WARNING: It is the ultimate buyer’s responsibility to have all bolts / nuts checked for tightness after the first 100 miles and then every 1000 miles. The steering, suspension and driveline systems, plus wheel alignment should be inspected by a qualified professional mechanic at least every 3000 miles.

TECH TIP / TIME SAVER...

- Some minor trimming will be required with certain wheel/ tire combination. This is normal with most aftermarket tire/wheel fitments on Toyota trucks. Trimming will normally include the bottom edge of the inner fender shrouds and/or lower corner of front bumper valance. As a rule of thumb, deeper backspacing and shorter/ narrower tires will reduce/eliminate trimming required.

TIRES & WHEELS...

Larger rim and tire combinations may increase leverage on suspension, steering, and related components. When selecting combinations larger than OE, consider the additional stress you could be inducing on the OE and related components.

⚠️ NOTE: Stock \ Factory 17", 18", 20" & 22" Wheels Will Fit back on the vehicle once this suspension system is installed. Aftermarket Wheels Require 5.25 Inch Back Spacing.

TIRE SIZE SPECIFICATIONS			
Tire Size	Wheel	Backspacing (INCH)	Offset (MM)
265/70 R17	17x9	5.25	+6mm
31x10.50 R17	17x9	5.25	+6mm
265/65 R18	18x9	5.25	+6mm
31x10.50 R18	18x9	5.25	+6mm
275/55 R20	20x9	5.25	+6mm
31x10.50 R20	20x9	5.25	+6mm
275/45 R22	22x9	5.25	+6mm
31x10.50 R22	22x9	5.25	+6mm

⚠️ WARNING: ANY larger or wider tire & wheel combination other than listed Will Require Vehicle Trimming.

* Some Minor Trimming Maybe Required.

⚠️ NOTE: ALL Tire & Wheel Combinations Should Be Test Fit Prior to Installation.

IMPORTANT DISCLAIMER: The provided tire/wheel fitments are approximate. Actual dimensions of a given tire size can vary considerably from one brand to another. Manufacturers’ wheel offset and backspacing measurement points are not always consistent. Backspacing greatly impacts tire-to-fender clearance when turning. Wheel width and backspacing influence whether the tires protrude past the fenders, and to what extent. Considering these important factors, we recommend that you fit-check your tire/wheel selection prior to purchasing.

TOOLS & TECH...

This is a list of tools needed to install this lift kit. Double check the list to make sure that you have all the tools and equipment required to accomplish the complete install.

We have also included a **Tech Tip** noted by this icon

🔧 TECH TIP to help if we have found a quicker or easier way to accomplish a task in the steps.

Tools		
Miscellaneous	Wrench / Socket Sizes	
	Standard	Metric
Floor Jack		
Jack Stands	7/16"	12mm
Hammer	3/4"	14mm
Pry Bar	7/8"	16mm
Plastic Fastern Removal Tool		17mm
Flat Screwdriver		19mm
Neddle-Nose Pliers		21mm

Torque Specifications					
STANDARD			METRIC		
Size	Grade 5	Grade 8	Size	Grade 8.8	Grade 10.9
5/16"	15 ft/lbs.	20 ft/lbs.	6mm	5 ft/lbs.	9 ft/lbs.
3/8"	30 ft/lbs.	35 ft/lbs.	8mm	18 ft/lbs.	23 ft/lbs.
7/16"	45 ft/lbs.	60 ft/lbs.	10mm	32 ft/lbs.	45 ft/lbs.
1/2"	65 ft/lbs.	90 ft/lbs.	12mm	55 ft/lbs.	75 ft/lbs.
9/16"	95 ft/lbs.	130 ft/lbs.	14mm	85 ft/lbs.	12 ft/lbs.
5/8"	135 ft/lbs.	175 ft/lbs.	16mm	130 ft/lbs.	165 ft/lbs.
3/4"	185 ft/lbs.	280 ft/lbs.	18mm	170 ft/lbs.	240 ft/lbs.

NOTE: Use the check-off box found at each step to help you keep your place. Two denotes that one check-off box is for the Driver Side (Left) and one is for the Passenger Side (Right). Unless otherwise noted, always start with the Driver Side.

FRONT DISASSEMBLY

NOTE: Save ALL factory components and hardware for reuse, unless noted.

PREPARE VEHICLE FOR FRONT...

1. Disconnect the battery.

Chock rear tires and place transmission in neutral. Raise the front of vehicle with a jack and secure a jack stand beneath each frame rail. Ease the frame down onto the stands, place transmission in low gear for Manual Transmission or Park for Automatic. Remove the front wheels & tires. [Lug Nuts 21mm]

REMOVE ABS BRACKET FROM UCA...

2. **[Illustration 1]** Remove the ABS bracket from the Upper Control Arm (UCA). [10mm]

WARNING: Be careful. Do not damage or overextend the ABS lines.

TECH TIP When you remove a factory nut or bolt, like the brake line & ABS bracket bolts, put it back into the factory spot for safe keeping. You will not have to look or sort through removed hardware to find the proper nut.

REMOVE BRAKE HOSE & ABS BRACKET FROM KNUCKLE...

3. **[Illustration 2]** Remove the (2) bolts that attach the brake hose & ABS bracket from the knuckle. [12mm]

[Illustration 1]

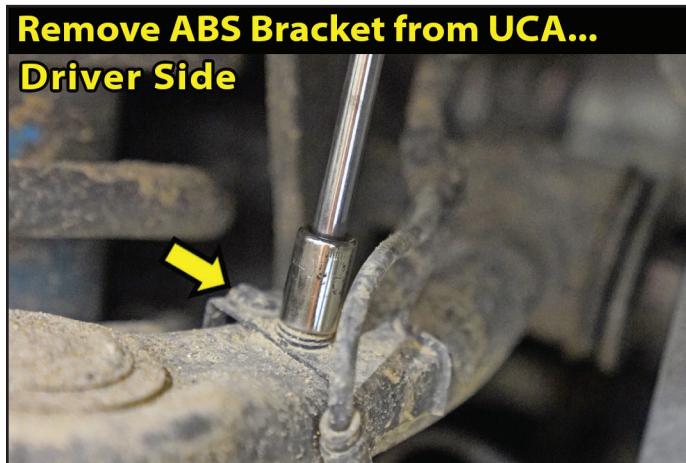

[Illustration 2]

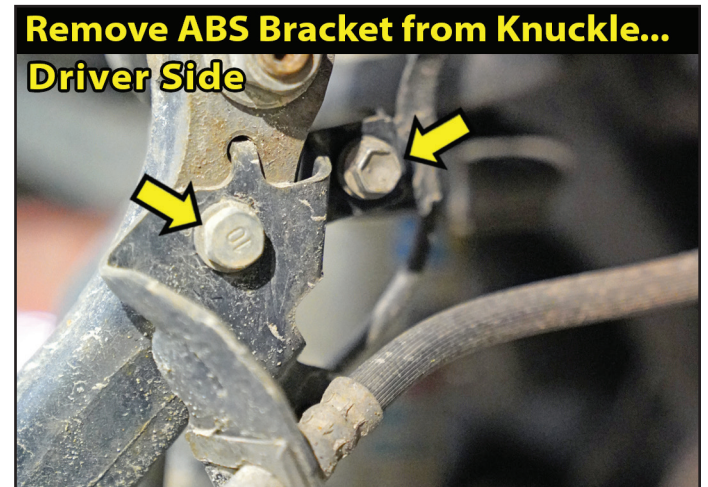

DISCONNECT TIE ROD FROM KNUCKLE...

4. **[Illustration 3]** Remove the tie rod retaining nut. [21mm] Reinstall the nut a couple of turns by hand.

Use a Tie Rod Puller to separate the tie rod from the knuckle.

TECH TIP If you do not have a puller, you can use the method of striking the knuckle near the ball joint end to dislodge the knuckle. Strike the knuckle portion only.

Remove the tie rod nut and save for re-install. Push the linkage forward until out of the way.

[Illustration 3]

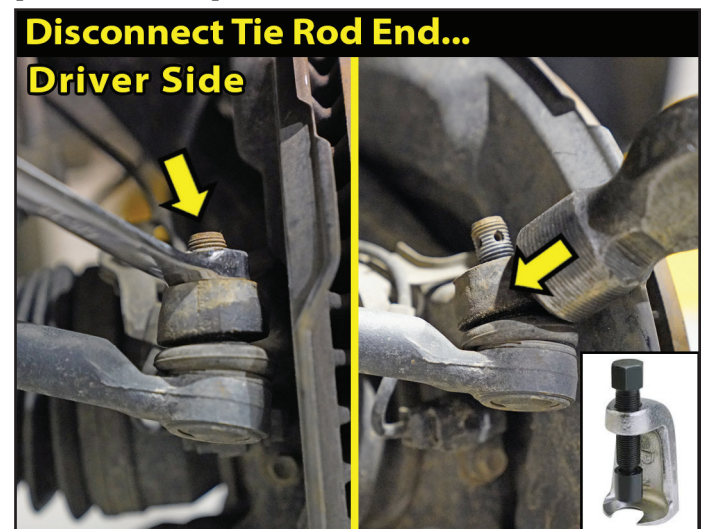

DISCONNECT SWAY BAR LINK...

5.  **[Illustration 4]** Disconnect the upper sway bar link from the knuckle. [15mm] Allow sway bar to drop, then rotate out of the way. Retain factory hardware.

DISCONNECT UPPER BALL JOINT FROM KNUCKLE...

6.  Support knuckle & Lower Control Arm (LCA) with jack stand and remove upper ball joint nut. [21mm]

 **TECH TIP** Turning the knuckle inward will allow easy access to the nut.

 **[Illustration 5]** Using the appropriate puller tool, disconnect the ball joints from the knuckle.

 **TECH TIP** If you do not have a puller tool you can use a hammer by very carefully striking the ball joint boss' of the knuckle; do not strike the ball joint.

⚠ WARNING: Be careful. Do not let the CV axle shaft dislodge from the CV cup or 'pull out' at the differential. Do not let the knuckle fall to the side abruptly. It could cause damage to the ABS wires or brake lines.

[Illustration 4]

**Disconnect Sway Bar from Knuckle...
Driver Side**



[Illustration 5]

**Disconnect Upper Ball Joint...
Driver Side**

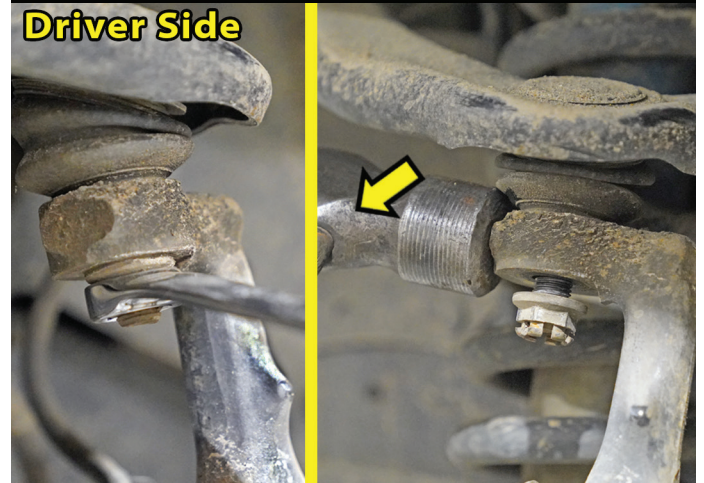
**DISCONNECT STRUT FROM LOWER CONTROL ARM...**

7.  **[Illustration 6]** Loosen the lower strut mount from the LCA. [[24mm & 21mm]] **⚠ NOTE:** Once you remove the lower strut bolt, the weight of the LCA is going cause it to drop/swing down quickly. Make sure the jack is in place.

DISCONNECT STRUT FROM STRUT TOWER...

8.  **[Illustration 7]** Remove the top (3) strut nuts from the upper strut tower at the frame. [14mm]

[Illustration 6]

**Disconnect Strut from LCA...
Driver Side**

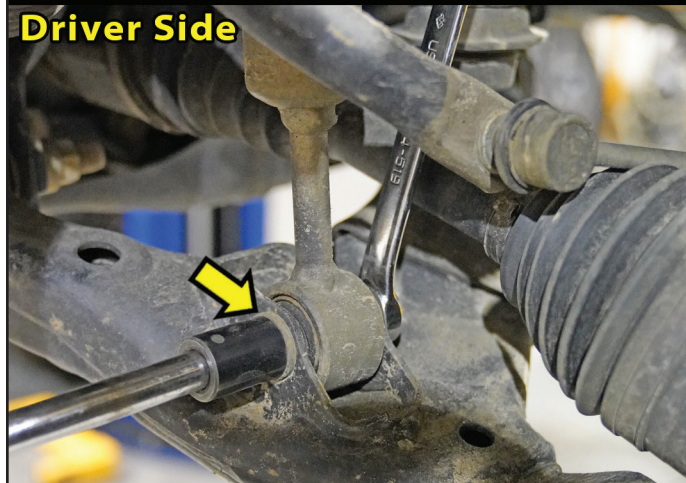

[Illustration 7]

**Disconnect Upper Strut Bolts...
Driver Side**

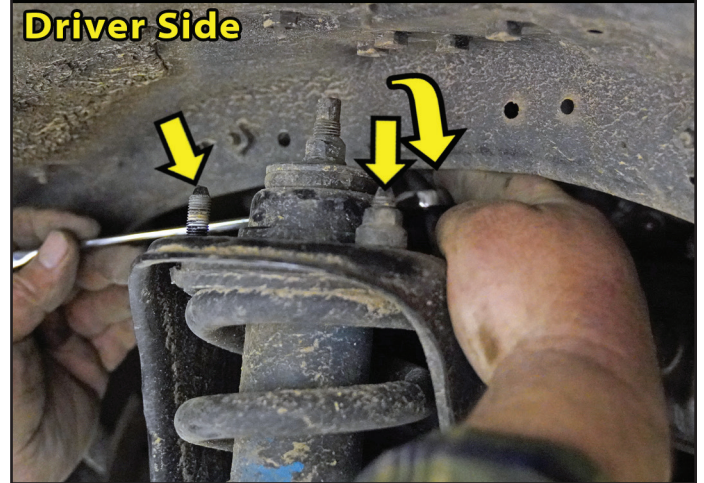

REMOVE STRUT...

9. **NOTE:** Before you completely remove the strut, 'Mark' the Alignment of the Coil, Top Mount & Isolator. Also Mark 'DR.' & 'PA.' Side.

[Illustration 8] Remove the lower strut bolt & nut from LCA. Retain factory hardware. **NOTE:** Once you remove the lower strut bolt, the weight of the arm is going cause it to drop/swing down quickly. Remove strut assembly from vehicle. [24mm & 21mm]

Repeat steps 2-9 on opposite side of vehicle.

FRONT ASSEMBLY**ASSEMBLE AND INSTALL STRUT SPACER...**

10. Locate the (2) SUPERLIFT strut spacers #55-01-40046. Locate Hardware Bag #77-40046. Hardware PER Side: (3) 10mm Nuts, (3) 10mm Lock Washers & (3) 10mm Flat Washers.

[Illustration 9-A] Position the strut spacer (#55-01-40046) onto the top of the factory strut over the factory studs. Attach with the factory hardware. [14mm]

Install upper strut assembly into strut tower. Secure with included 10mm flange nuts. [17mm]

TECH TIP The strut assembly will only fit one way. Rotate the assembly 180° or front to back.

[Illustration 9-B] Install lower strut mount to LCA. Insert bolt Rear-to-Front. [24mm & 21mm] Torque to factory specs.

[Illustration 9-A]

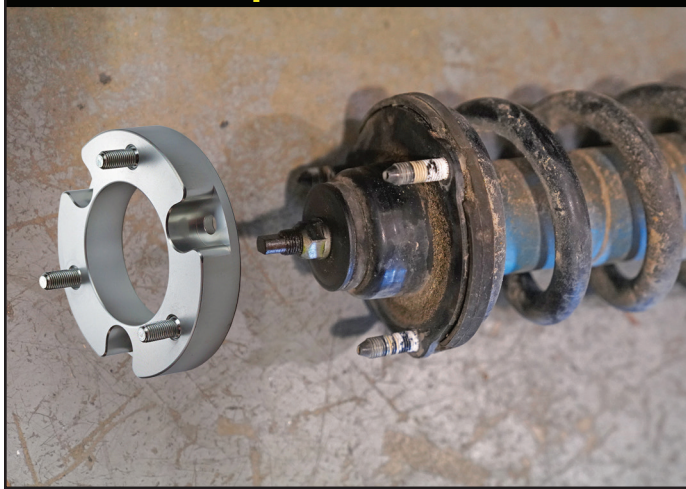
Install Strut Spacer...

[Illustration 8]

Mark & Remove Strut...**Driver Side**

[Illustration 9-B]

Install Lower Strut Mount...**Driver Side**

CONNECT UPPER BALL JOINT TO KNUCKLE...

11.  [Illustration 10] Raise lower control arm with jack. Connect upper ball joint on upper control arm to knuckle. [21mm] Torque to factory specs. Install cotter key.

CONNECT TIE ROD TO KNUCKLE...

20.  [Illustration 11] Reinstall tie rod steering linkage up from the bottom to the knuckle. [21mm] Torque to factory specs. Install cotter key.

[Illustration 10]

Connect Upper Ball Joint to Knuckle...
Driver Side

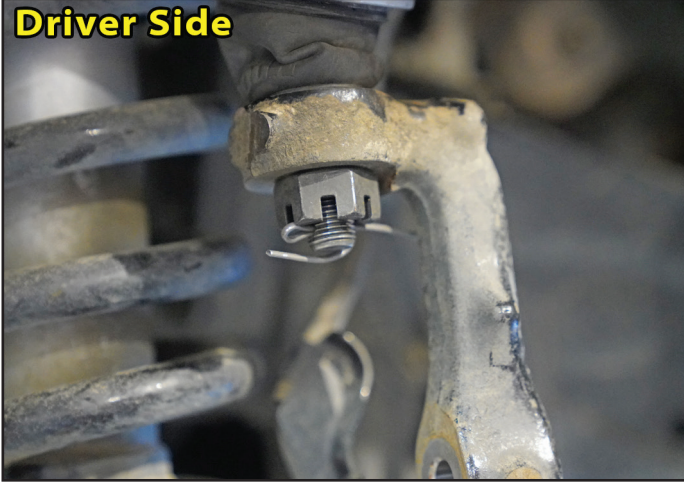

[Illustration 11]

Connect Tie Rod to Knuckle...
Driver Side

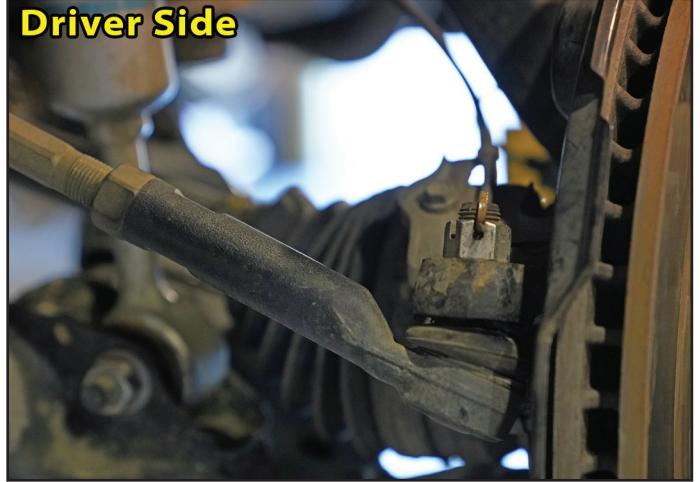
**CONNECT SWAY BAR TO KNUCKLE...**

12.  [Illustration 4] Rotate the sway bar back into the OE position. Connect the upper sway bar link to the knuckle. [15mm] Torque to factory specs.

REATTACH BRAKE HOSE & ABS BRACKET FROM KNUCKLE...

13.  [Illustration 2] Reattach the (2) bolts that attach the brake hose & ABS bracket to the knuckle. [12mm]

REATTACH ABS BRACKET TO UCA...

14.  [Illustration 1] Reattach the ABS bracket to the Upper Control Arm (UCA). [10mm]

Repeat steps 10-14 on opposite side of vehicle.

FRONT TIRES / WHEELS...

15.  Install the front tires & wheels. [Lug Nuts 22mm] (140)

⚠WARNING: When the tires / wheels are installed, always check for and remove any corrosion, dirt, or foreign material on the wheel mounting surface, or anything that contacts the wheel mounting surface (hub, rotor, etc.). Installing wheels without the proper metal-to-metal contact at the wheel mounting surfaces can cause the lug nuts to loosen and the wheel to come off while the vehicle is in motion.

Lower the vehicle to the ground.

⚠WARNING: Re-tighten lug nuts at 500 miles after any wheel change, or anytime the lug nuts are loosened. Failure to do so could cause wheels to come off while vehicle is in motion.

Lug Nut Torque Sequence...

Follow the Sequence Below to Torque the Lug Nuts

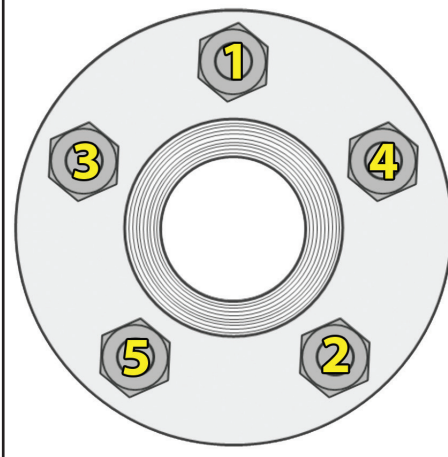
**Lug Nut Torque Sequence...**

Follow the Sequence Below to Torque the Lug Nuts

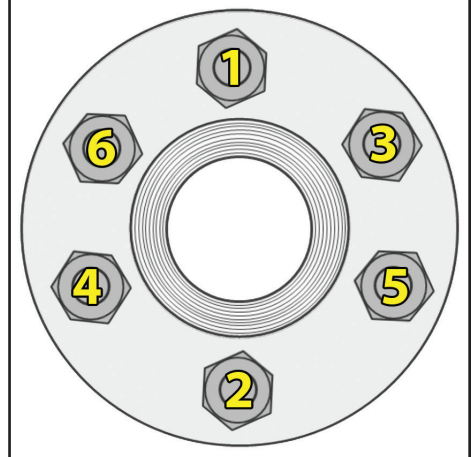

FRONT CLEARANCE CHECK...

16. With the vehicle on the ground, cycle the steering lock-to-lock and check all components for proper operation and clearances. Pay special attention to the clearance between the tires / wheels and knuckles, brake hoses, wiring, etc.

Raise the vehicle back onto jack stands and secure as per **Step 1**. With the suspension 'hanging' at full extension travel, cycle the steering lock-to-lock and check all components for proper operation and clearances. Pay special attention to the clearance between the tires / wheels and knuckles, brake hoses, wiring, etc. Lower the vehicle to the floor.

FINAL CHECKS**CLEARANCE CHECK...**

17. Check all hardware for proper torque specifications.

With the vehicle on the ground, check all components for proper operation and clearances. Pay special attention to the clearance between the tires / wheels, brake hoses, wiring, etc. Check tire/wheel clearance with the fenders/bumper as well as with the steering knuckle. **⚠ NOTE:** Depending on your choice of tire size and wheel width, it is not uncommon to trim the lower plastic valance of the bumper and inner fender shroud slightly to add proper tire clearance while turning.

WHEEL ALIGNMENT...

18. Realign vehicle to factory OEM specifications. It is necessary to have a proper and professional wheel alignment performed by a certified alignment technician. It is recommended that your vehicle alignment be checked after any off-road driving.

HEADLIGHTS...

19. Re-adjust headlights to proper setting. In addition to your vehicle alignment, for your safety and others, it is necessary to check and adjust your vehicle head lamps for proper aim and alignment.

FOUR WHEEL DRIVE...

20. Activate the four wheel drive system and check for proper engagement.

SUPERLIFT WARNING DECAL...

21. Install the **WARNING TO DRIVER** decal on the inside of the windshield, sun visor or on the dash, within Driver's view.

IMPORTANT MAINTENANCE INFORMATION

⚠ WARNING: It is the ultimate buyer's responsibility to have all bolts / nuts checked for tightness after the first 100 miles and then every 1000 miles. The steering, suspension and driveline systems, plus wheel alignment should be inspected by a qualified professional mechanic at least every 3000 miles.

LIMITED LIFETIME WARRANTY / WARNINGS

Your SUPERLIFT® product is covered by the Limited Warranty explained below that gives you specific legal rights. This limited warranty is the only warranty SUPERLIFT® makes in connection with your product purchase. SUPERLIFT® neither assumes nor authorizes any retailer or other person or entity to assume for it any other obligation or liability in connection with this product or limited warranty.

SUPERLIFT, LLC, LIMITED LIFETIME WARRANTY

What is covered? Subject to the terms below, SUPERLIFT® will repair or replace its products found defective in materials or workmanship for so long as the original purchaser owns the vehicle on which the product was originally installed. Your warranter is SUPERLIFT, LLC, doing business as SUPERLIFT® Suspension Systems ("SUPERLIFT®").

What is not covered? Your SUPERLIFT® Limited Warranty does not cover products SUPERLIFT® determines to have been damaged by or subjected to:

- Alteration, modification or failure to maintain.
- Normal wear and tear (bushings, rod ends, etc.). Scratches or defects in product finishes (powder coating, plating, etc.).
- Damage to, or resulting from, the vehicle's electronic stability system, related components or other vehicle systems.
- Racing or other vehicle competitions or contests. Accidents, impact by rocks, trees, obstacles or other aspects of the environment.
- Theft, vandalism or other intentional damage.

Remedy Limited to Repair or Replacement. The exclusive remedy provided hereunder shall, upon SUPERLIFT's inspection and at SUPERLIFT's option, be either repair or replacement of the product covered under this Limited Warranty. Customers requesting warranty consideration should contact SUPERLIFT® by phone (1-800-551-4955) to obtain a Returned Goods Authorization number. All removal, shipping and installation costs are customer's responsibility.

If a replacement part is needed before the SUPERLIFT® part in question can be returned, you must first purchase the replacement part. Then, if the part in question is deemed warrant-able, you will be credited / refunded.

OTHER LIMITATIONS - EXCLUSION OF DAMAGES - YOUR RIGHTS UNDER STATE LAW

- Neither SUPERLIFT® nor your independent SUPERLIFT® dealer are responsible for any time loss, rental costs, or for any incidental, consequential or other damages you may have.
- This Limited Warranty gives you specific rights, and this is the only warranty SUPERLIFT® makes in connection with your product purchase. You may also have other rights that vary from state to state. For example, while all implied warranties are disclaimed herein, any implied warranty required by law is limited to the terms of our Limited Lifetime Warranty as described above. Some states do not allow limitations of how long an implied warranty lasts and / or do not allow the exclusion or limitation of incidental or consequential damages, so the limitations and exclusions herein may not apply to you. SUPERLIFT® neither assumes nor authorizes any retailer or other person or entity to assume for it any other obligation or liability in connection with this product or Limited Warranty.

IMPORTANT PRODUCT USE AND SAFETY INFORMATION / WARNINGS

⚠️ WARNING: As a general rule, the taller a vehicle is, the easier it will roll over. Offset, as much as possible, what is lost in rollover resistance by increasing tire track width. In other words, go “wide” as you go “tall”; always use as wide a tire and wheel combination as feasible to enhance vehicle stability. We strongly recommend, because of rollover possibility, that the vehicle be equipped with a functional roll bar and cage system. Seat belts and shoulder harnesses should be worn at all times. Avoid situations where a side rollover may occur.

Generally, braking performance and capabilities are decreased when significantly larger / heavier tires and wheels are used. Take this into consideration while driving. Also, changing axle gear ratios or using tires that are taller or shorter than factory height will cause an erroneous speedometer reading. On vehicles equipped with an electronic speedometer, the speed signal impacts other important functions as well. Speedometer recalibration for both mechanical and electronic types is highly recommended.

Do not add, alter, or fabricate any factory or aftermarket parts to increase vehicle height over the intended height of the SUPERLIFT® product purchased. Mixing component brands is not recommended.

⚠️ NOTE: WE WANT TO SEE YOUR RIDE...

Grab photos of your SUPERLIFT Equipped truck in various poses and in action.

Email pictures to us at sales@superlift.com

Tag us on **Facebook:** [@superlift suspension systems](https://www.facebook.com/superlift_suspension_systems)

Tag us on **Instagram:** [#superlift](https://www.instagram.com/superlift), [#superliftsuspension](https://www.instagram.com/superliftsuspension), [#superliftequipped](https://www.instagram.com/superliftequipped)

THANKS For Choosing SUPERLIFT...

For questions, technical support and warranty issues relating to this SUPERLIFT products, please contact SUPERLIFT directly.

**SUPERLIFT SUSPENSION
300 Huey Lenard Loop Rd.
West Monroe, Louisiana 71292
Phone: (318) 397-3000
Sales / Tech: (800) 551-4955
Fax: (318) 397-3040
SUPERLIFT.COM**