



INSTALLATION GUIDE

2006-CURRENT HONDA RIDGELINE



PRODUCT CODE:

720



January 5, 2011

TOOLS NEEDED

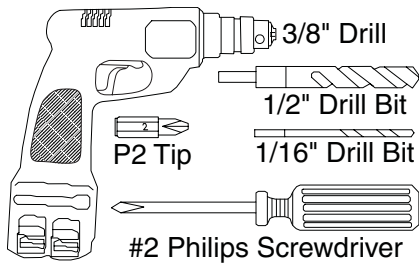

COMPONENTS INCLUDED

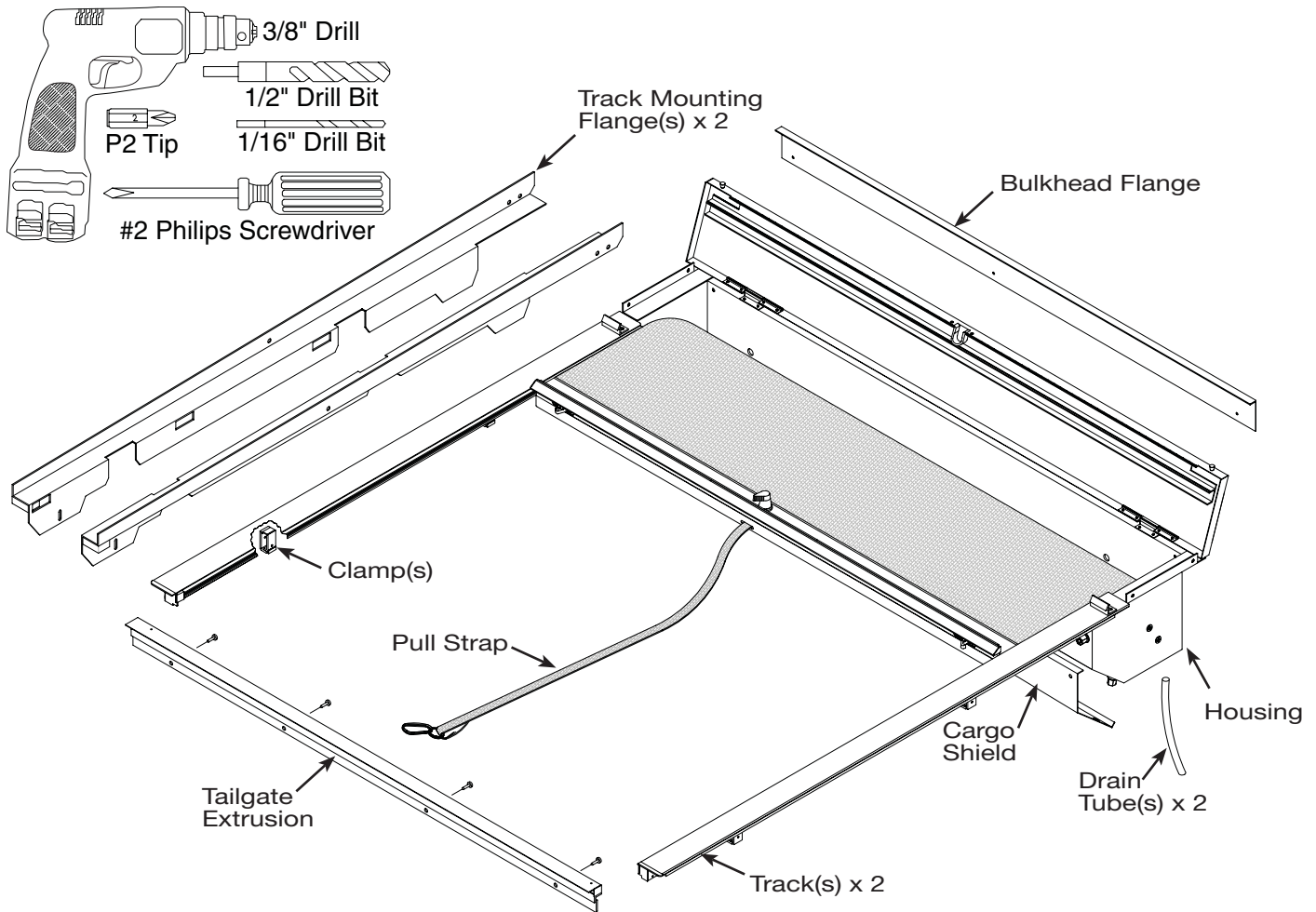

STEP 1: INSTALL BULKHEAD ADAPTER

- A.** Remove the forward upper Tie Down Brackets (**Photo 1**).



- B.** Remove the two (2) upper Bedrail bolts per side (**Photos 2 & 3**).

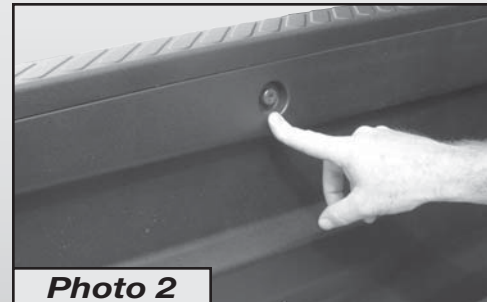

- C.** Remove the three (3) upper Bulkhead bolts (**Photo 4**).

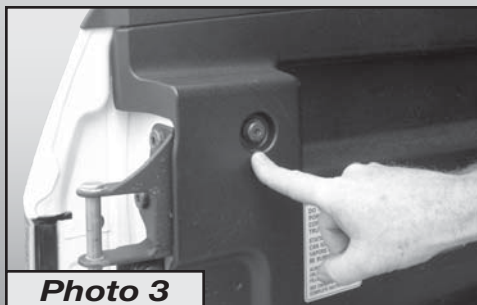

NOTE: There are a total of eleven (11) bolts to be removed.

STEP 2: INSTALL MOUNTING FLANGES ON BEDRAILS AND BULKHEAD

Note: Notice that two sizes of metric bolts have been provided.

The four (4) large 8mm x 40mm bolts are to

be used in the forward positions of the Track Mounting Flanges where the tiedown brackets were removed (**Photo 1**). The seven (7) smaller 6mm x 40mm bolts are to be used in all the other locations.

- A.** Begin by applying the Butyl caulking strips to the cab end of the Track Mounting Flanges (**Photo 5**). Place the strip on the Flange edge, and press the material onto the Flange so that caulking material is equally distributed on both sides of the Flange (**Photo 6**).
- B.** Next, key the driver's side rack Mounting Flange into the slot between the bulkhead and the bedrail (**Photo 7**), being sure that the caulking is pressed into the slot.
- C.** Using a 6mm x 40mm bolt and rectangular shim, secure the Track Mounting Flange at the center position. Slip the shim behind the Flange and align the hole in the shim with the hole in the Flange, allowing the bolt to pass through (**Photo 8**).
Note: Leave this connection loose.
- D.** Secure the front and back connection points. Leave the connections loose.
- E.** With the driver's side Track Mounting Flange in place, repeat sub-steps A - C for the passenger's side.
- F.** Secure the Bulkhead Flange. Begin at the center position (**Photo 9**), making sure to leave it loose.

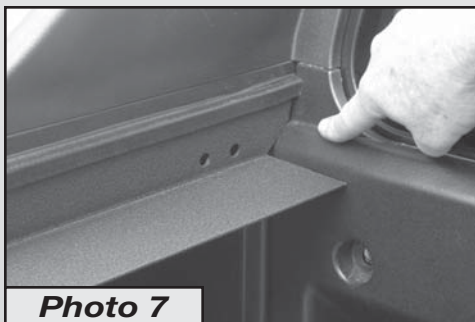

STEP 2: INSTALL MOUNTING FLANGES ON BEDRAILS AND BULKHEAD (CONTINUED)

- G.** Move to one end and raise the Bulkhead Flange up as far as it will go, and tighten (**Photo 10**). Repeat procedure on the opposite end, and then snug the center bolt. **Note: Do not over-tighten, as the Flange will distort.**

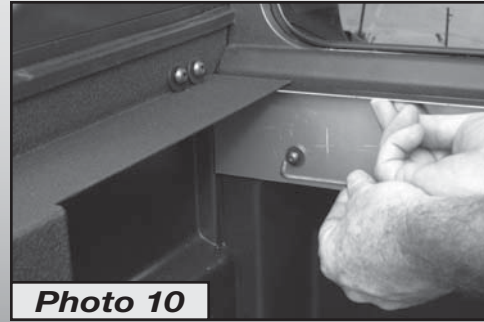

Photo 10

- H.** Tighten all eight (8) Track Mounting Flange bolts.

STEP 3: INSTALL THE HOUSING ASSEMBLY

- A.** Place the Housing Assembly onto the Track Mounting Flanges (**Photo 11**), centering it between the two, with the Housing's back-flange overlapping the Bulkhead Flange. This is best accomplished with two people.

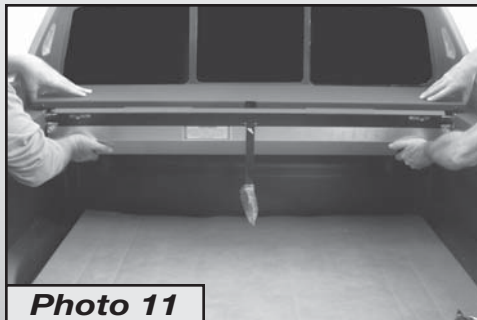

Photo 11

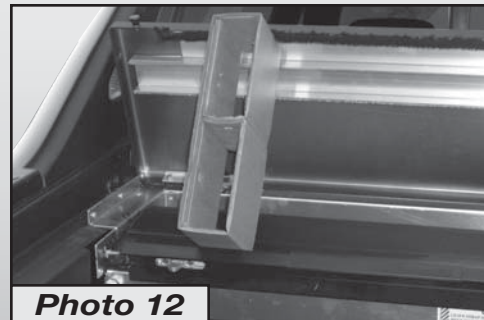

Photo 12

- B.** Lift the Lid on the Housing and prop it against the cab. A piece of packaging material works well for this purpose (**Photo 12**).

STEP 4: INSTALLING THE TRACKS

- A. Making sure to leave the Pull-Strap connected to the threaded Shipping Stud, raise the Housing Lid and**

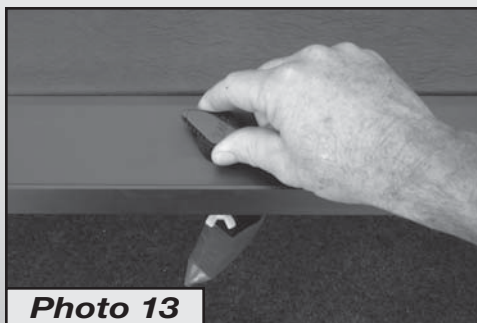

Photo 13

rotate the Lock Lever to the 10 o'clock position (**Photo 13**).

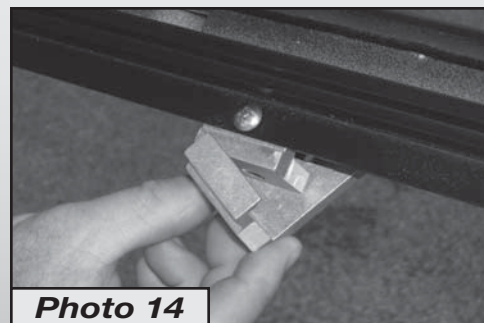
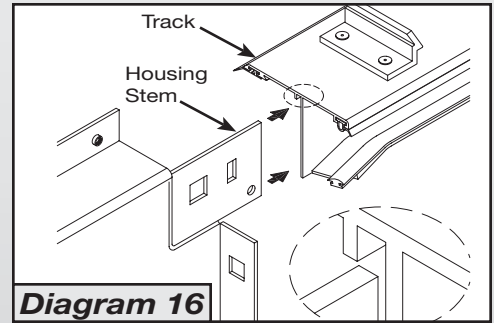
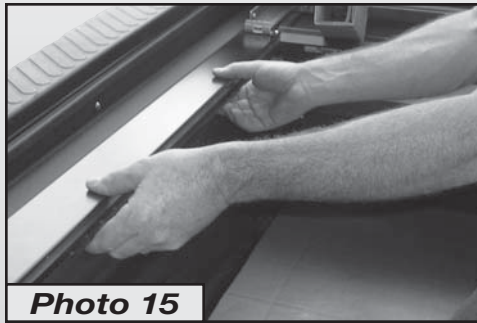

Photo 14

- B.** Remove the 'L' shaped sections of the Clamps which are taped to the bottoms of the Track Clamps (**Photo 14**).

STEP 4: INSTALLING THE TRACKS (CONTINUED)

- C.** Carefully place the Tracks onto the Track Mounting Flange (**Photo 15**) and key it onto the Housing Stem (**Diagram 16**), being sure that the Handle is properly engaged into the Tracks.



- D.** Attach both Clamps loosely to the Track Mounting Flange (**Photo 17**).

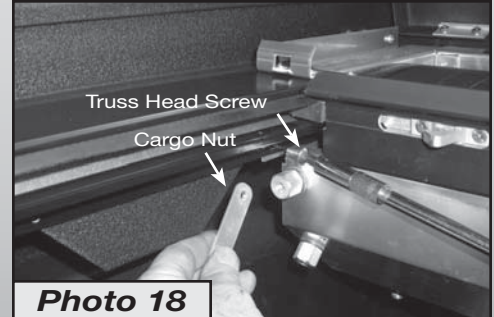

- E.** Use #10-24 x 1/2" truss head screws and Cargo Nuts to secure the Tracks to the Housing Stems (**Photo 18**). Tighten connections securely.

STEP 5: INSTALL THE TAILGATE EXTRUSION

- A.** Locate the center of the tailgate by carefully closing the tailgate, being sure not to strike the ends of the Tracks. Measure 24 3/4" from the face of the bed post and place a mark (**Photo 19**).
- B.** Measure again from the opposite bed post and place a mark at 24 3/4". If there is a space between the marks, split the difference.
- C.** Measure and mark the center of the Tailgate Extrusion.
- D.** Lower the tailgate and center the Tailgate Extrusion on the tailgate by aligning your marks.



STEP 5: INSTALL THE TAILGATE EXTRUSION **(CONTINUED)**

- E.** Being sure to hold the Tailgate Extrusion to the tailgate, use a drill with a 1/16" bit and drill a pilot hole through the center holes of the Tailgate Extrusion into the tailgate (**Photo 20**). Use a #8 x 3/4" self tapping screw and power screw gun to secure (**Photo 21**). Drill and secure each end hole, being sure to hold the Extrusion square and tight to the tailgate, continue to secure two additional holes.

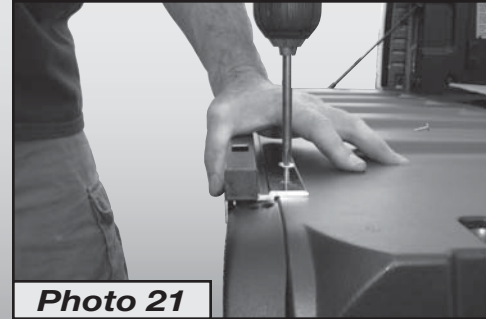

Photo 21

STEP 6: ORIENTING THE TRACKS TO THE TAILGATE

- A.** Move to the front of the bed, lift up slightly on the Housing and shift each side back toward the tailgate (**Photo 22**)



Photo 22

so that the Track End Caps contact the inside surface of the tailgate and match up with the Tailgate Extrusion End Caps (**Photo 23**).

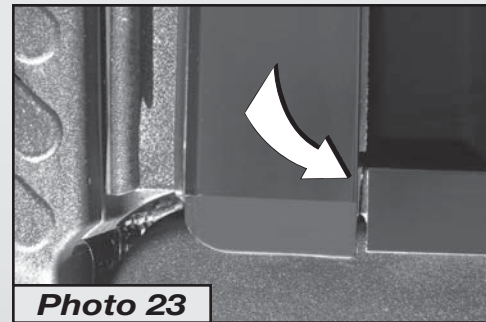

Photo 23

NOTE: The Track End Caps are in contact with the Tailgate Extrusion End Caps. If the Tracks are not positioned as shown, the Lock mechanism will not function correctly.

- B.** With the Tracks in the correct position, you may now tighten the Clamps. Begin with the back Clamp first and be sure the Tracks remain level while tightening.



Photo 24

NOTE: Do not use a power or pneumatic screw gun to tighten the Clamps.

- C.** Once both Tracks are tightened, carefully open and close the tailgate to make sure the Tracks are positioned high enough to prevent the tailgate from striking them. If there is a problem, loosen the bolt which secures the end of the Track Mounting Flange (**Photo 24**) and raise the Flange just enough to correct the problem.

STEP 7: INSTALL CARGO BUMPER AND DRAIN TUBES

- A.** Trim the Track Gasket 1" from the end of the Track (*Photo 25*).



- B.** Rotate the Lock Lever to the 7 o'clock (closed)

position (*Photo 26*), then remove the plastic wing-nut and detach the Pull Strap from the shipping stud (*Photo 27*). Pull the Cover closed and latch it to the tailgate. **NOTE: Do not allow the Cover to retract while the Housing Lid is open.**



- C.** Before lowering the Housing Lid, turn the Lid Pin knobs 1/4 turn clockwise, which will cause the Pins to pop in if they are not already in. Lower the Housing Lid being sure that the Lid Pins snap into the receptors located on the Tracks.



- D.** To open the Cover pull back slightly on the Handle to relieve spring tension from the Latch Mechanisms and turn the Lock Lever clockwise to the 10 o'clock (unlatched) position.

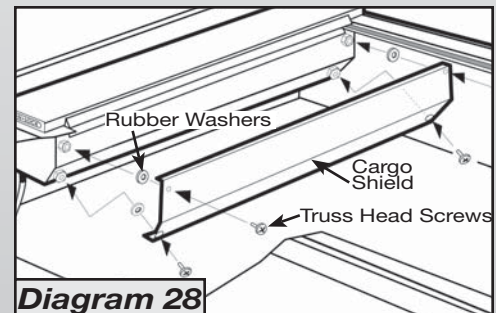

- E.** Use 1/4-20 x 1/2" truss head screws and rubber washers to secure the Cargo Shield (*Diagram 28*). **NOTE: that the rubber washers go on the inside of the Cargo Shield.**

- F.** Use a 1/2" bit to drill two holes for the Drain Tubes. Note that this process is much easier if a 1/4" pilot hole is drilled first.

CAUTION!!! There are only two (2) locations (1 in each corner) on the Honda Ridgeline where you can drill holes for the Drain Tubes. Pay close attention to the dimensions shown (*Photo 29*).

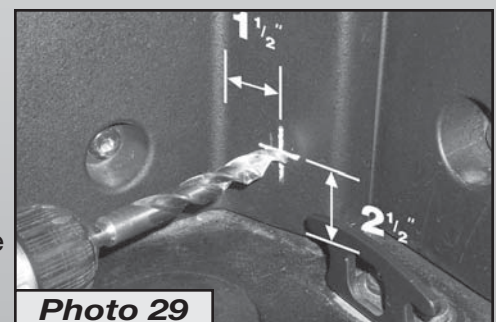

- G.** Press the Drain Tubes onto the drain fittings that protrude from the bottom of the Housing assembly, and then push a minimum of 2" of each tube through the holes you've drilled. (*Photo 30*). Standard scissors can be used to trim the tubes to the appropriate length.

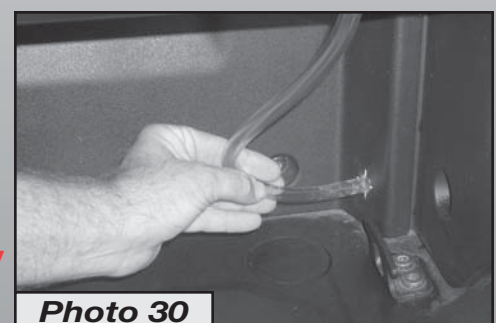

- H.** **Always make sure the Pull Strap is securely clipped to a fixed point in the bed.**

STEP 8: TESTING UNIT OPERATION

In Step 7, the Cover was opened (*retracted*). This would have caused the Lock Lever to enter the Lock Pocket and rotate to the 7 o'clock (*latched*) position.

- A. To close the Cover,** pull the Pull-Strap hand-over hand, allowing the excess strap to fall into the bed until you can reach the Handle. Place your hands evenly spread on the Handle and pull the Handle until it contacts the Tailgate Extrusion. As the Handle contacts the Tailgate Extrusion the spring loaded latches (*which were energized when the cover was retracted*) will automatically trip, simultaneously latching the Cover to the tailgate and side Tracks.
- B. To open the Cover,** pull back slightly on the Handle to relieve spring tension from the Latch Mechanisms and turn the Lock Lever clockwise to the 10 o'clock position. The Cover should retract on its own with only a slight push to set it into motion. When the Cover is retracting it is best to hold the Pull-Strap and allow it to slip through your fingers as the Cover travels. Applying pressure to the Pull-Strap as it slips through your fingers will act as a braking action, preventing the Handle from slamming into the Lid at high speed. The Cover must retract with only enough force to rotate and reset the Lock Lever and Latching Mechanism.

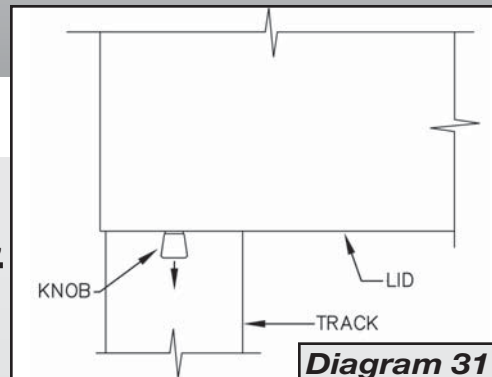

STEP 9: INSTRUCTIONS FOR OPENING AND CLOSING THE HINGED LID

To Open:

- A.** Grasp the Latch Pin Knobs located at the back corners of the Lid (*Diagram 31*) and pull them out.
- B.** Turn the knobs 90° to hold the Latch in the unlocked position (*Diagram 32*).
- C.** Grasp the Lid and lift (*Diagram 33*). Rest the Lid against the back of the cab to hold it open for service or cleaning.

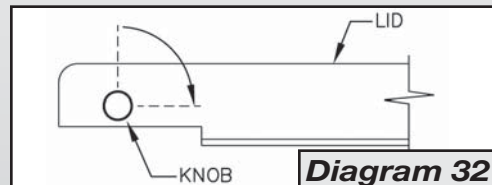

To Close:

- A.** Reverse the previous steps. Lower the Lid and return the Latch Pins to the locked position by turning the knobs ¼ turn. **Note: The Latch Pins may be returned to the locked position before or after closing the Lid.**

