



INSTALLATION GUIDE
2002-09
DODGE 1500-3500



PRODUCT CODE:
445 & 455



May 17, 2011

TOOLS NEEDED

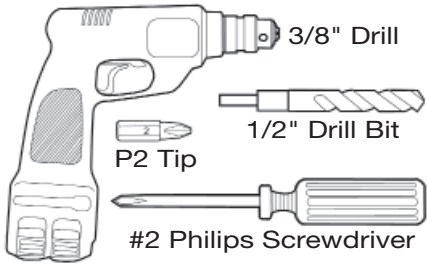

COMPONENTS INCLUDED

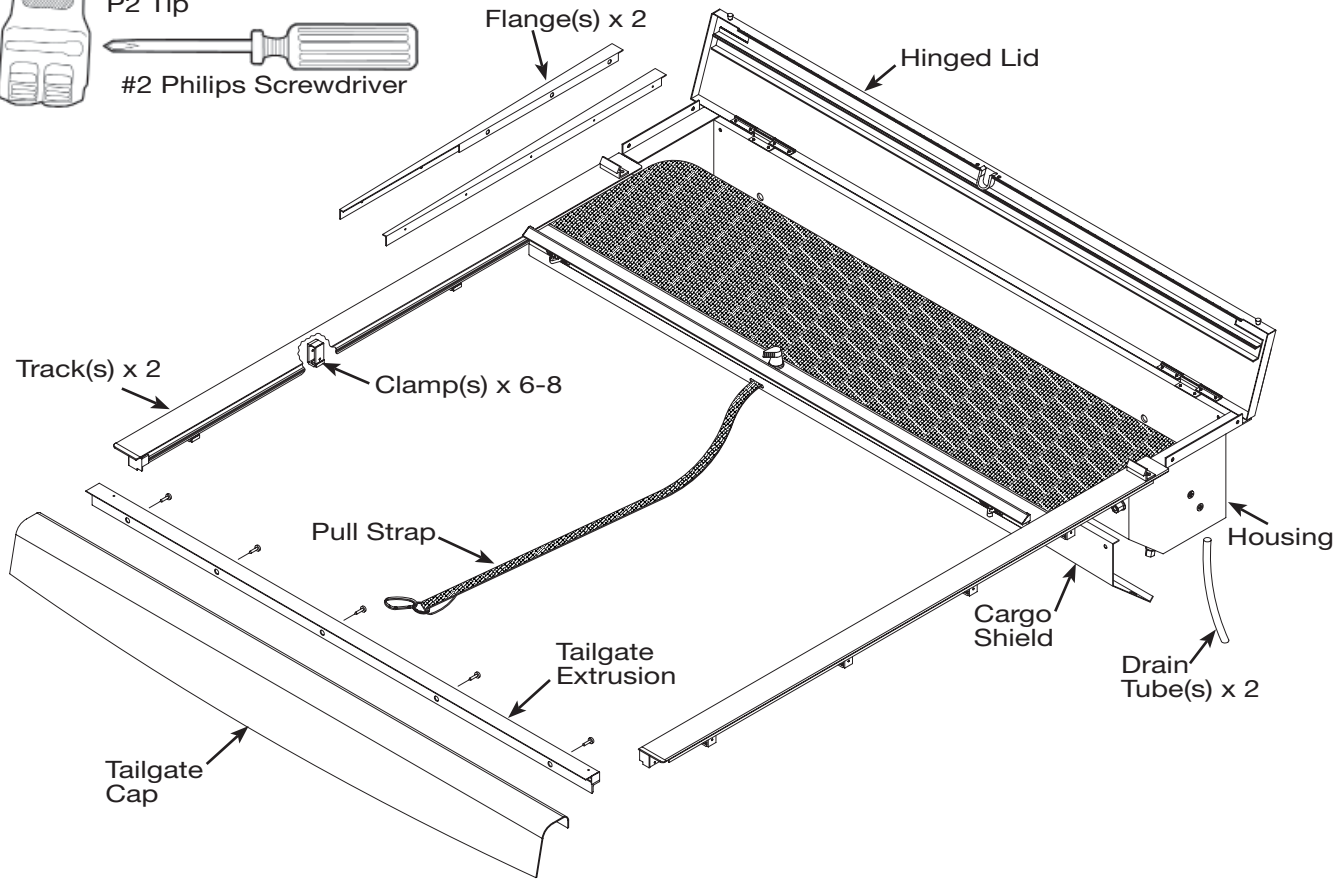

STOP!

**IF YOU HAVE A PLASTIC
DROP-IN BEDLINER, BE
SURE TO FOLLOW STEP 1
ON THE NEXT PAGE.**



**IF NO BEDLINER IS
PRESENT, PROCEED TO
STEP 2.**

STEP 1: BEDLINER MODIFICATION

Note: If the truck is equipped with a plastic drop-in bedliner, some alteration will be necessary. **If no bedliner is present, proceed to Step 2.**

A. The dotted lines in **Diagram 1** depict the more common **under-the-rail** liner modifications.

1. Using a jig saw with a medium tooth blade, remove the bulkhead portion of the liner as indicated.
2. **Be sure to trim the bedliner's plastic tailgate panel as shown.**

B. The dotted lines in **Diagram 2** depict the less common **over-the-rail** liner modifications.

1. Using a jig saw with a medium tooth blade, remove the bulkhead portion of the liner as indicated.
2. If a rear notch is necessary, place the Tracks on their respective bedrails and mark the positions of the most rearward Clamps prior to removing the liner. *(The correct position of the Track is with the black plastic Track End Cap touching the inside surface of the tailgate.)*

3. When the modification is complete, push the wall of the liner under the bedrail.
4. **Be sure to trim the bedliner's plastic tailgate panel as shown.**

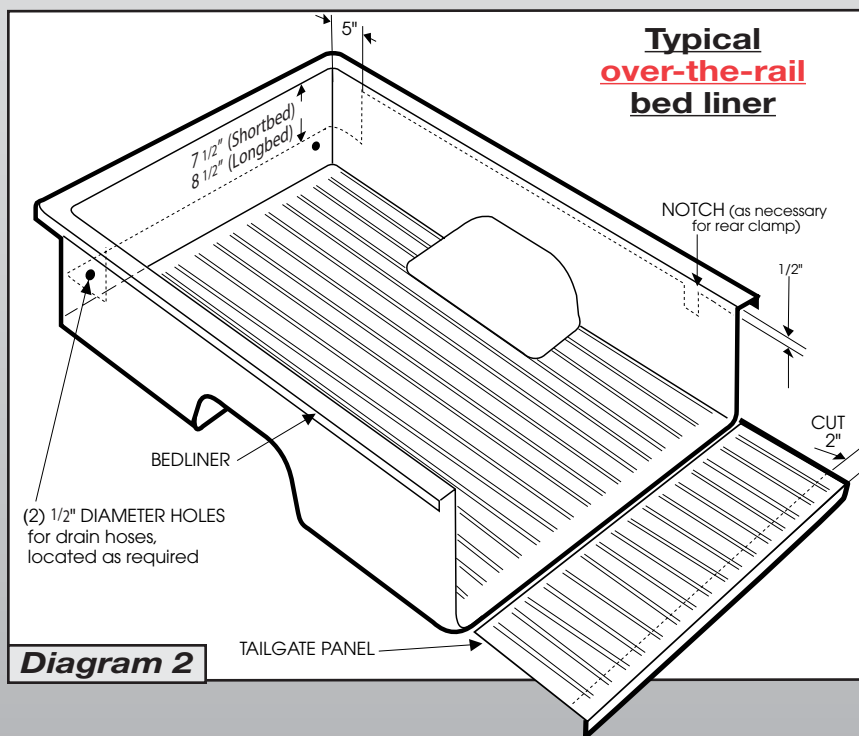
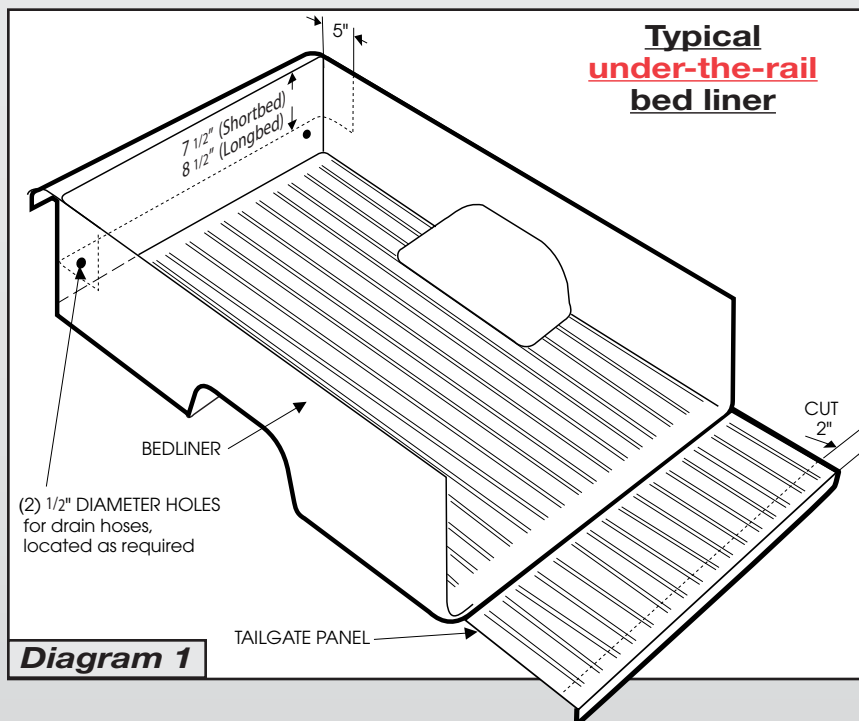

STEP 2: INSTALL THE MOUNTING FLANGES

- A.** Place the Mounting Flange onto the down flange of the bedrail, keeping the forward notches seated against the bulkhead and being sure that the top of the flange is exactly flush with the top of the bedrail (**Photo 3**).

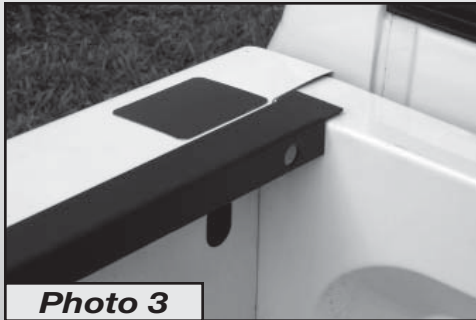

- B.** Use #8 x 3/4" self tapping screws to secure the Mounting Flanges to the bedrails (**Photo 4**).

STEP 3: INSTALL THE HOUSING

- A.** If desired, install the Stake-Pocket Hole Covers where necessary (**Photo 5**).
- B.** Place the Housing Assembly onto the Mounting Flanges (**Photo 6**). Center it between the Mounting Flanges and leave about 1/2" of space between the bulkhead and the back of the Housing. **Do not fasten the housing in place.**

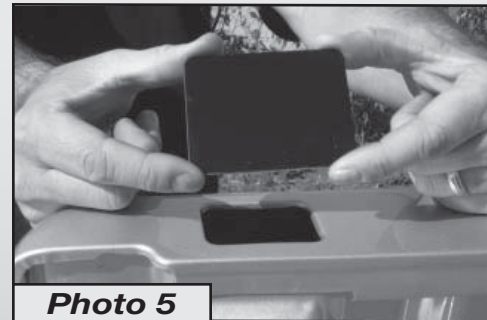

- C.** Lift the Lid on the Housing and lean it against the cab (**Photo 7**). Place a rag between the Lid and cab to prevent scratches.

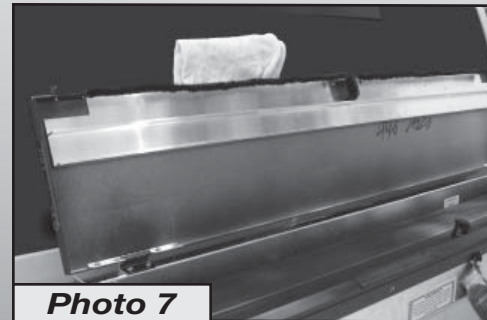

STEP 4: INSTALL THE TRACKS

- A.** Making sure to leave the Pull Strap connected to the threaded shipping stud, rotate the Lock Lever to the 10 o'clock position (**Photo 8**).



STEP 4: INSTALL THE TRACKS (CONTINUED)

- B.** Remove the “L”-shaped sections of Clamps that are taped to the bottoms of the Tracks.

Because these are location-specific, be sure to lay them in the bed in the same order as you remove them from the Tracks.



Photo 9

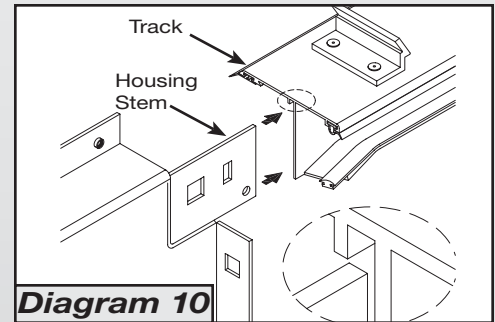

Diagram 10

- C.** Carefully place the Tracks

on the Mounting Flanges (**Photo 9**) and key them onto the Housing Stems (**Diagram 10**), being sure that the Handle is properly engaged into the Tracks.



Photo 11

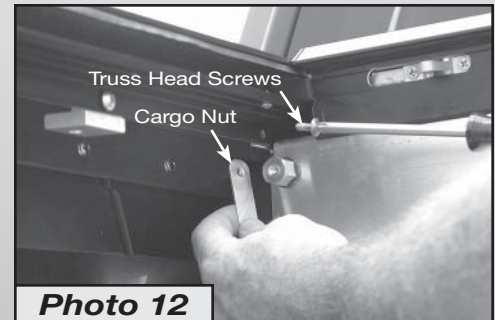

Photo 12

- D.** Attach the back Clamps very loosely to the Tracks to be sure that the Tracks do not fall off of the Mounting Flanges while proceeding (**Photo 11**).
- E.** Use #10-24 x 1/2" truss head screws and Cargo Nuts to secure the Tracks to the Housing Stems (**Photo 12**). Tighten these connections securely.
- F.** Attach the remaining Clamps very loosely. **Do not tighten yet.**

STOP!



If your truck is equipped with the factory tailgate spoiler, remove it (Photo 13) and install



Photo 13

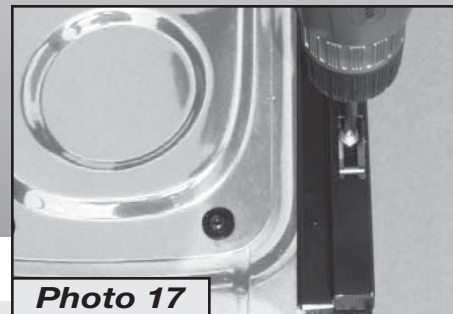

Photo 14

the formed Tailgate Cap provided with this unit (Photo 14). If your truck has no such spoiler, proceed to Step 5.

STEP 5: INSTALL THE TAILGATE EXTRUSION

- A.** Lower the tailgate and, using a tape measure, locate and mark the center of the tailgate (*Photo 15*).
- B.** Using a tape measure, locate and mark the center of the Tailgate Extrusion (*Photo 15*).
- C.** While holding the Tailgate Extrusion square and centered on the tailgate, use a #8 x 3/4" self-tapping screw and power screw gun to secure the hole nearest center (*Photo 16*). Next, move to each end, **press the Tailgate Extrusion to the top of the tailgate in order to make it conform to the contour of the tailgate, and secure it in place.**
- D.** Install the remaining self-tapping screws, making sure to provide even spacing between them. **Note that if you have replaced the factory tailgate spoiler, it is important to install the left and right end self-tapping screws (*Photo 17*).** In doing so, it is important to locate the screws away from the lock pins to avoid conflict with the latches.
- E.** With the Tailgate Extrusion secured, carefully close the tailgate, being cautious not to strike the ends of the Tracks.



STEP 6: ORIENTING THE TRACKS TO THE TAILGATE

- A.** Move to the front of the bed, lift up slightly on the Housing and shift each side back toward the tailgate (*Photo 18*) so that the Track End Caps contact the inside surface of the tailgate. Make sure



- the Track End Cap Metal Blocks contact the Tailgate Extrusion End Caps (*Photo 19*). **Note that if the Tracks are not positioned as shown, the Latch Mechanism will not function correctly.**
- B.** With the Tracks in the correct position, you may now tighten the Clamps in the order shown (*Diagram 20*), taking care to make sure the Tracks remain level. **Do not use a power or pneumatic screw gun. Over tightening Track Clamps can cause an indentation in the bedrails.**

STEP 6: ORIENTING THE TRACKS TO THE TAILGATE (CONTINUED)

- C.** If the Track pitches upward, loosen the Clamp, rotate the Track level and install the optional Angularity Adjustment Screw as shown (**Diagram 21**). Tighten the Screw until it biases against the bedrail down-flange as shown.

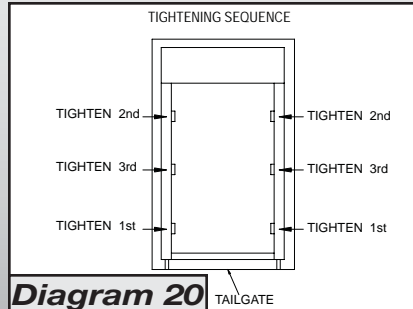

Diagram 20

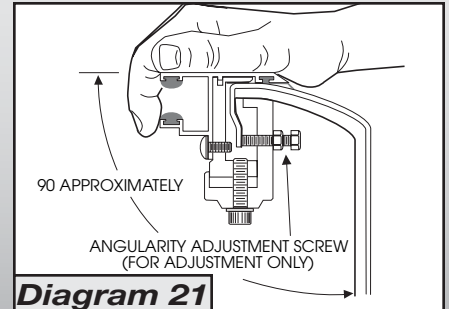

Diagram 21

STEP 7: INSTALL CARGO SHIELD & DRAIN TUBES

- A.** Trim the track gasket 1" from the end of the Track (**Photo 22**).

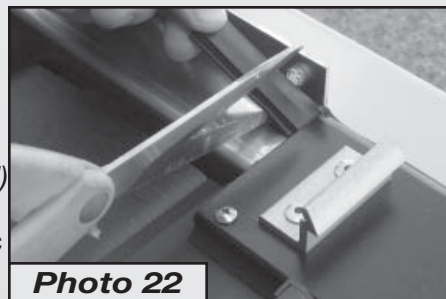

Photo 22

- B.** Rotate the Lock Lever to the 7 o'clock (*closed*) position (**Photo 23**), then remove the plastic wing nut and detach the Pull Strap from the threaded Stud (**Photo 24**). Pull the Cover closed and latch it to the tailgate. **Note: Do not allow the Cover to retract while the Housing Lid is open.**



Photo 23

- C.** Before lowering the Housing Lid, turn the Lid Pin Knobs $\frac{1}{4}$ turn clockwise, which will cause the pins to pop in if they are not already. Lower the Housing Lid, being sure that the Lid Pins snap into the receptors located on the Tracks.



Photo 24

- D.** To open the Cover pull back slightly on the Handle to relieve spring tension from the Latch Mechanisms and turn the Lock Lever clockwise to the 10 o'clock (*unlatched*) position.

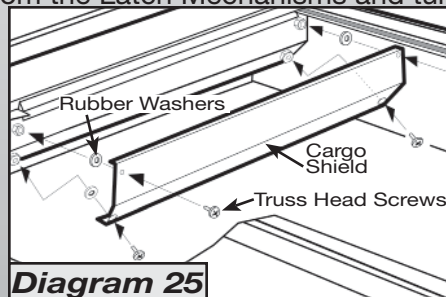

Diagram 25

- E.** Use 1/4-20 x 1/2" truss head screws and rubber washers to secure the Cargo Shield (**Diagram 25**).

Note: The rubber washers go on the inside of the Cargo Shield.

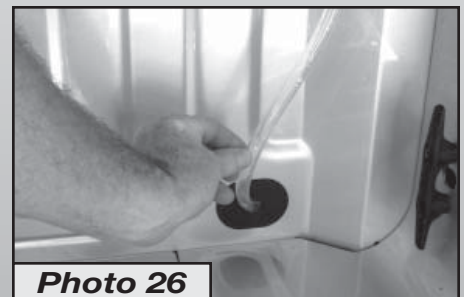

Photo 26

- F.** Use 1/2" bit to drill 2 holes for the Drain Tubes. Note that this process is easier if 1/4" pilot hole is drilled first. Align the holes with the Drain Fittings that protrude from the bottom of the Housing Assembly (**Photo 26**). If provided, locate the Drain Tubes in factory drain holes or bulkhead plugs.

- G.** **Always make sure the Pull-Strap is securely clipped to a fixed point in the bed.**

STEP 8: TEST UNIT OPERATION

In **Step 7** the Cover was opened (*retracted*). This should have caused the Lock Lever to enter the Lock Pocket and rotate to the 7 o'clock (*latched*) position.

- A.** To close the Cover, pull the Pull-Strap hand-over hand, allowing the excess strap to fall into the bed until you can reach the Handle. Place your hands evenly spread on the Handle and pull the Handle until it contacts the Tailgate Extrusion. As the Handle contacts the Tailgate Extrusion the spring loaded Latches (*which were energized when the Cover was retracted*) will automatically trip, simultaneously latching the Cover to the tailgate and side Tracks.
- B.** To open the Cover, pull back slightly on the Handle to relieve spring tension from the Latch Mechanisms and turn the Lock Lever clockwise to the 10 o'clock position. The Cover should retract on its own with only a slight push to set it into motion. When the Cover is retracting it is best to hold the Pull-Strap and allow it to slip through your fingers as the Cover travels. Applying pressure to the Pull-Strap as it slips through your fingers will act as a braking action, preventing the Handle from slamming into the Lid at high speed. The Cover must retract with only enough force to rotate and reset the Lock Lever and Latching Mechanism.

STEP 9: OPENING AND CLOSING / ADJUSTING THE HINGED LID

To Open:

- A.** Grasp the Latch Pin Knobs, pull out and turn knobs 90° to hold Pin in the unlock position. Grasp the Lid and lift. Rest the Lid against the back of the cab to hold open for service or cleaning (*Diagram 27*).

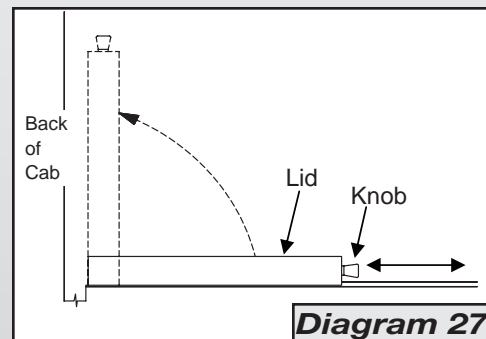

To Close:

- A.** Lower the Lid and return the Latch Pins to locked position by turning the knobs 1/4 turn.

If Lid is loose:

- A.** Raise Lid and loosen the nylock nut on each Lid Latch Bracket, move the top half of the Bracket one notch toward the tailgate. Tighten both nuts and close Lid (*Diagram 28*).

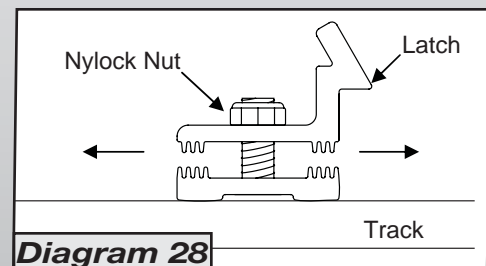

If Lid is tight:

- A.** Raise Lid and loosen the nylock nut on each Lid Latch Bracket, move the top half of the Bracket one notch toward the Housing. Tighten both nuts and close Lid (*Diagram 28*). Repeat if further adjustments are needed.