



INSTALLATION INSTRUCTIONS



2014 FIAT 500L 1.4L TURBO

PART NO. 15312

BILL OF MATERIALS:

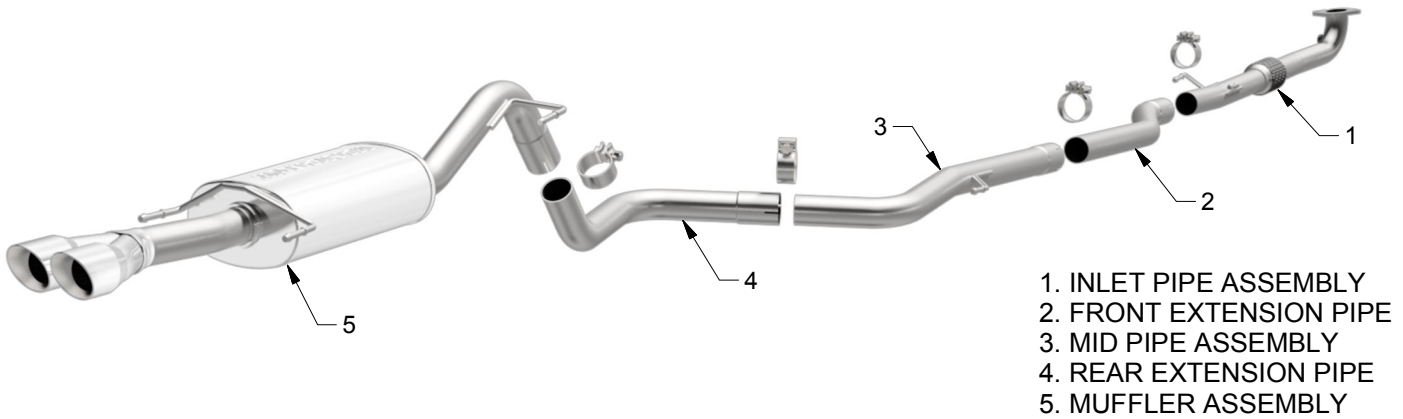

WEAR SAFETY GLASSES



READ INSTRUCTIONS THOROUGHLY BEFORE INSTALLING PRODUCT

SHOP SUPPLIES:



SPRAY LUBRICANT

To ease removal of existing exhaust components (especially on older vehicles) spray penetrating lubricant on all fasteners and hangers/insulators that will be loosened or removed and let soak before disassembly.

HARDWARE KIT:

- 1.[4] 2.25" Clamp
- 2.[1] Gasket
- 3.[1] Nut M8-1.25

MINIMUM REQUIRED TOOLS:



7/8"
(Or o2 Sensor Tool)



12mm, 13mm
14mm, 15mm



Hanger Tool
(Or Pry Bar)



Sawzall or other cutting device.

MAGNAFLOW RECOMMENDS PROFESSIONAL INSTALLATION ON ALL THEIR PRODUCTS



WARNING: When working on, under, or around any vehicle exercise caution. Please allow the vehicle's exhaust system to cool before removal, as exhaust system temperatures may cause severe burns. If working without a lift always consult vehicle manual for correct lifting specifications. Always wear safety glasses and ensure a safe work area. Serious injury or death could occur if safety measures are not followed.

ATTENTION: Always install any supplied band or U-bolt clamps to the proper torque specifications of 40-45 ft-lbs for band clamps and 30-35 ft-lbs for U-bolt clamps. Over tightening will result in the clamp breaking and will NOT be warranted by MagnaFlow.

INSTALLATION INSTRUCTIONS

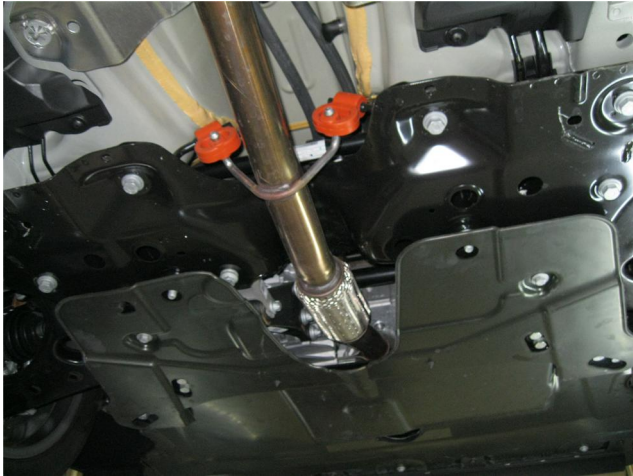

Step 1. Start by removing the engine shield at the front of the vehicle. Underneath this shield is a cross brace that must also be removed.



Step 2. Using a Sawzall (or other cutting device) cut the OEM exhaust just in front of the rear muffler. This step is critical as the exhaust cannot be removed without cutting.

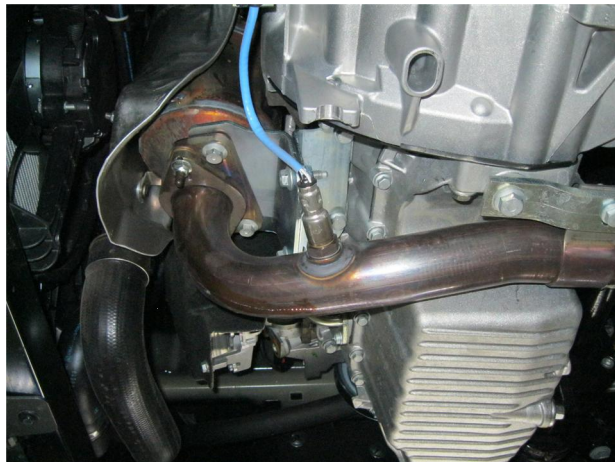

Step 3. Remove the O2 sensor (Unplug the wire connector the prevent damage to the wires)



Step 4. Disengage the the exhaust hangers from the rubber insulators (Save the insulators as they will be re-used on the new system)

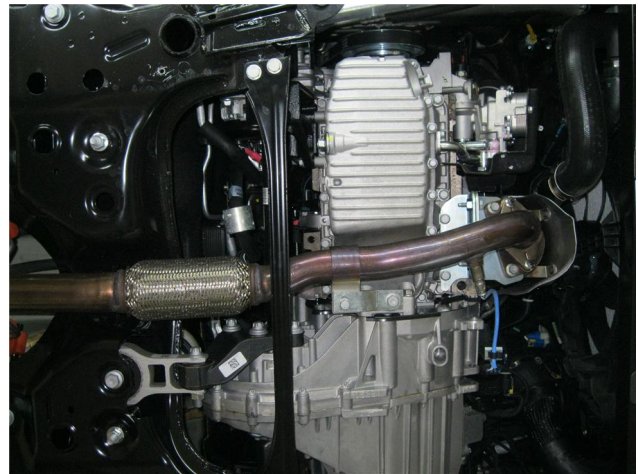

Step 5. Un-fasten the exhaust from the bracket attaching it to the transmission. Un-fasten the nuts attaching the flange at the bottom of the exhaust manifold and remove exhaust.

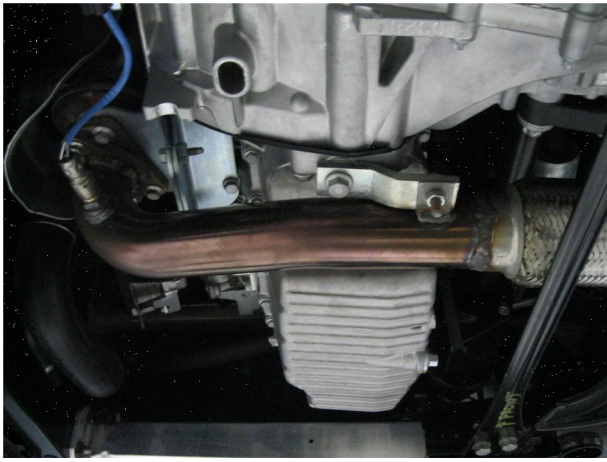

Step 6. Begin installation of your new MAGNAFLOW exhaust system by attaching the Inlet Pipe Assembly using the OEM nuts at the flange and the OEM bolt and supplied M8 nut at the transmission mount. Insert hangers into OEM rubber insulators and re-install the cross brace and o2 sensor.

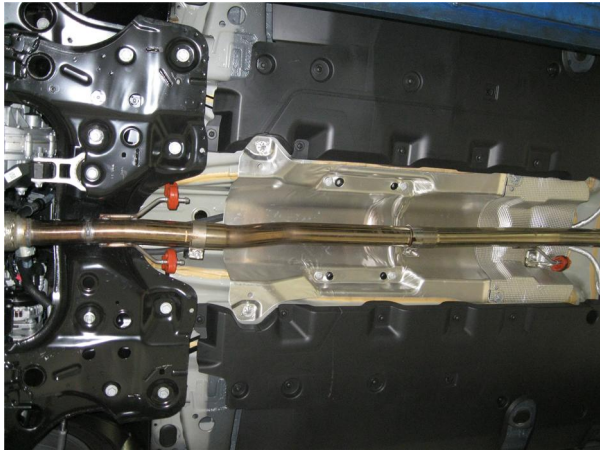

Step 7. Next, install the Front Extension Pipe using the supplied 2.25" clamp (keep clamps loose until final adjustment of system).

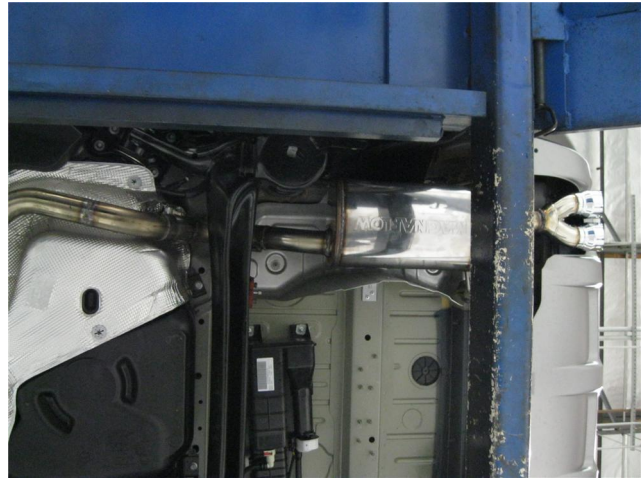

Step 8. Working front to rear install the remaining parts in the same fashion as the Inlet Extension Pipe, fitting hangers into rubber insulators and keeping clamps loose.



Step 9. Once a final position has been chosen for the new exhaust system, evenly tighten all clamps from front to rear using the torque specifications on page one of the instructions. Finish by re-installing the engine shield. Inspect all fasteners after 25-50 miles of operation and re-tighten if necessary.