



3651 N Highway 89 • Chino Valley, AZ 86323
 (928) 636-7080 • www.orfab.com

**JEEP TJ, YJ, & UNLIMITED (TJL)
 SWING-A-WAY TIRE CARRIER
 SWING-A-WAY TIRE/CAN CARRIER**

1987-95 YJ Kits # 85095, 86095
 1997-2006 TJ & TJL Kits # 85201, 86201

⚠WARNING
 Read and understand all instructions, warnings, cautions, and notes in this sheet and in your owners manual before you begin the installation of this tire/tire-can carrier kit.

⚠CAUTION
 Proper installation of a ORFab tire carrier kit requires knowledge of the factory recommended procedures for disassembly and assembly of original equipment components. We recommend that the factory shop manual and any special tools necessary to your vehicle be on hand during the installation. Installation of this tire carrier lift kit without proper knowledge of the factory recommended procedures may affect the performance of these components and the safety of your vehicle. We strongly recommend that a certified mechanic familiar with the installation of similar components install this tire carrier kit.

⚠NOTE
 These instructions cover TJ, YJ, and TJL models; some images may not match your vehicle. The Tire/Can Carrier is designed to use lip-style Gerry cans. To carry non-lip cans, you need the optional Non-Lip Can Carrier Adapter, Kit # 87013 .

Before starting installation

⚠WARNING
 The load rating for these tire-can/tire carriers is a **MAXIMUM** of 175 lbs . Please be aware that some tire and wheel combinations along with gas cans and hi-lift jacks can exceed this **MAXIMUM** rating. If weight exceeds don't mount hi-lift jack to carrier.

⚠WARNING
 Some states require a center high-mount stop lamp by law. OR-FAB recommends that you consult your state laws before you install this kit. If required, you will need optional ORF (CHMSL) kit # 87017 .

⚠NOTE
 Kit parts are prefaced by the word **kit** and appear in **bold print**.

1. Carefully read all warnings and instructions completely before beginning.
2. Verify all parts have been received in this kit by checking the parts list at the end of this document.
3. Only install all this kit on the vehicle for which it is specified . If anytime during the installation you encounter something different from what is outlined in the instructions, call technical support at (928) 636-7080.
4. Park the vehicle on a clean, dry, flat, level surface and block the tires so the vehicle cannot roll in either direction.

Prepare to install kit

1. Remove spare tire.
2. Center stop lamp.
 - a. Remove screw and cover from open tailgate.

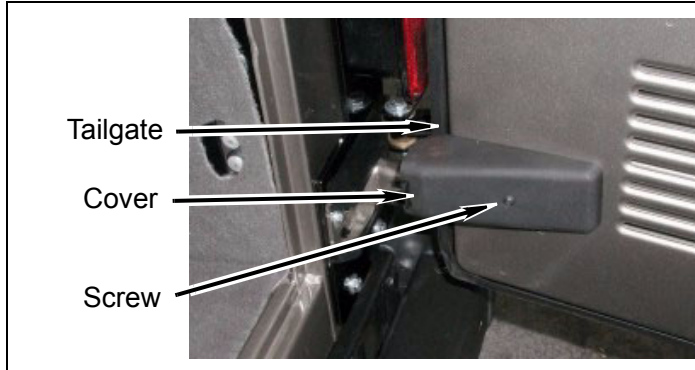

△NOTE
 Note location of taped wire before disconnecting it.

- b. Disconnect center stop lamp wire connectors from tailgate bracket.

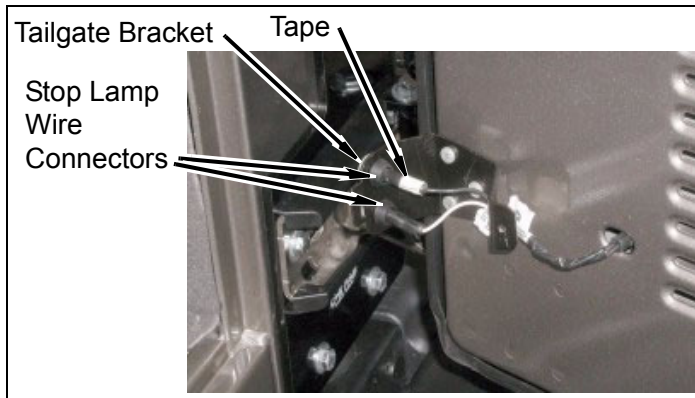

- c. Remove grommet and wire harness from tailgate.

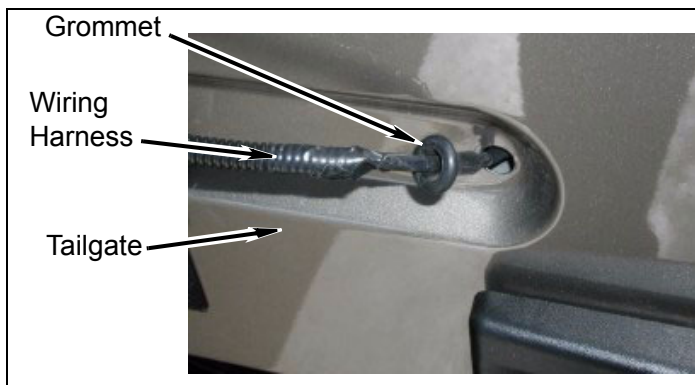

- d. Remove four bolts and center stop lamp from spare tire bracket.

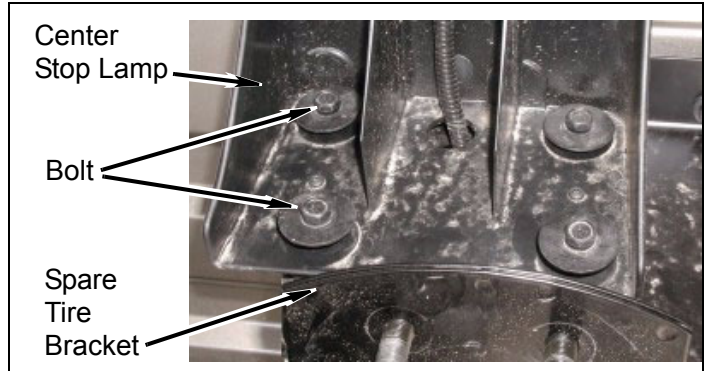

3. Spare tire bracket.
 - a. Remove four bolts and spare tire bracket from tailgate.

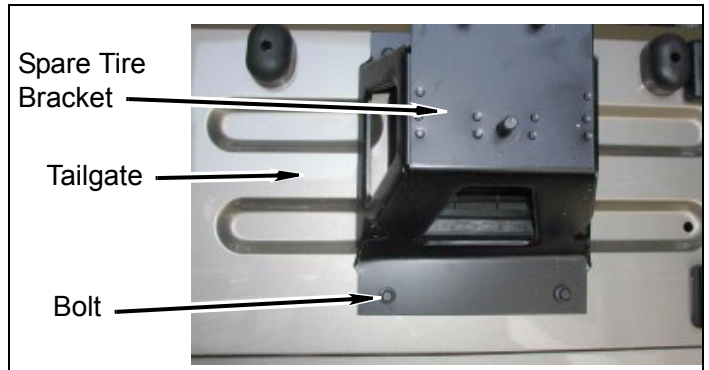

△NOTE
 When installing the tire carrier kit it is helpful to remove the vehicle top.

4. Tailgate.
 - a. **2004 models:** Open tailgate, un-clip and remove two upper and lower plastic covers from tailgate hinges.

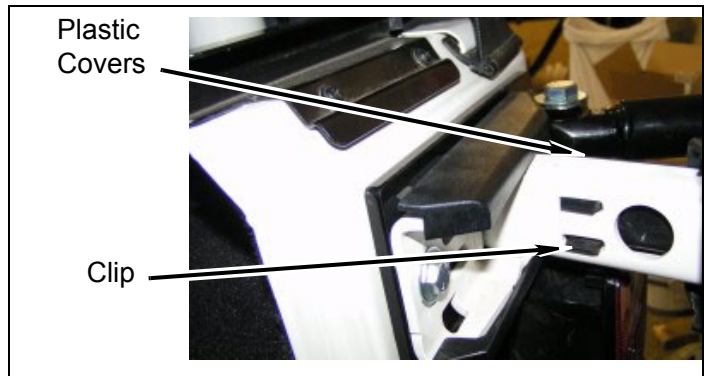

- b. **2004 models:** Slightly twist the upper edge and remove two upper and lower plastic covers from the body side of the hinges.

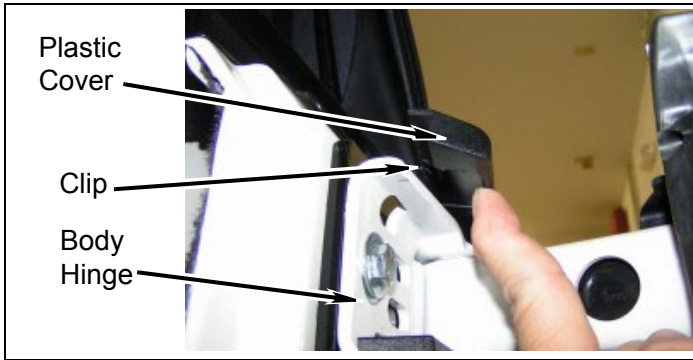

NOTE
 In the step below a hobby knife makes a perfect cut for separating the body paint and the hinge bolts.
2003 and older: The double nut fasteners will not be reused.
2004-2006: The upper captive nuts will be dealt with later in these instructions.

- c. Remove four bolts, tailgate, hinges, and two sets of double nut fasteners from body.

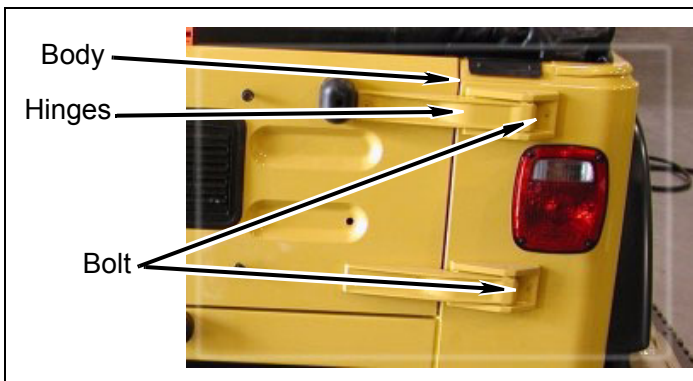

- d. Position tailgate on the ground. Remove four bolts and tailgate hinges from tailgate.

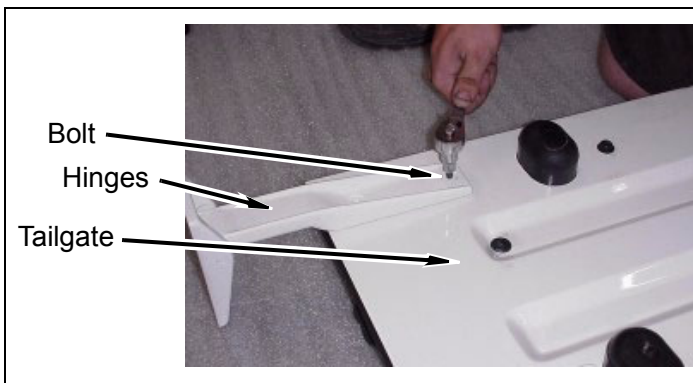

- e. Install two kit **tailgate hinge plates** and tailgate hinges on tailgate.

Cast Aluminum Hinge:

Install four kit **bolts** (5/16" x 1 1/2" allen head).

Stamped Steel Hinge:

Install four kit **bolts** (5/16" x 1 1/4") and four kit **washers** (5/16" USS).

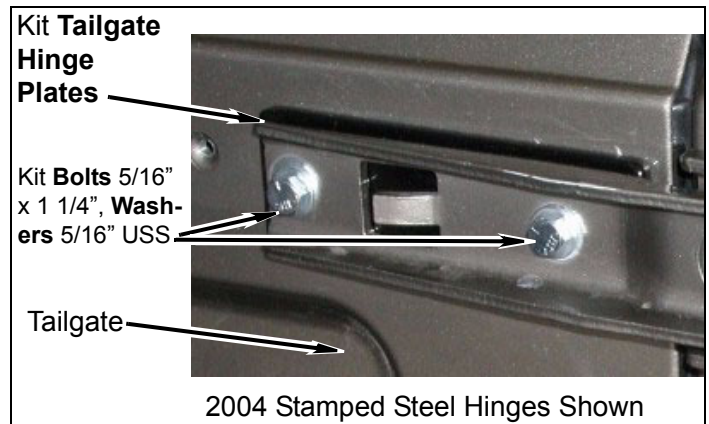

5. **2002 and older:** Inner fender.

- a. Remove push clip and inner fender from the back portion of body. Pull the inner fender out from under rear quarter panel as shown.

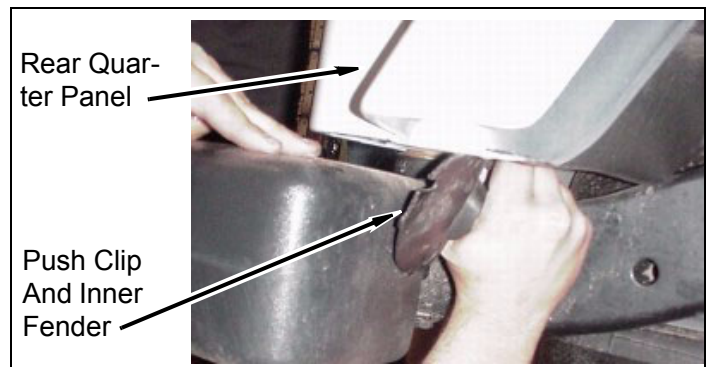

6. **2003-2006:** Inner fender and air canister.

- a. Remove seven push clips, two locator tabs, and fender liner from passenger side rear wheel well.

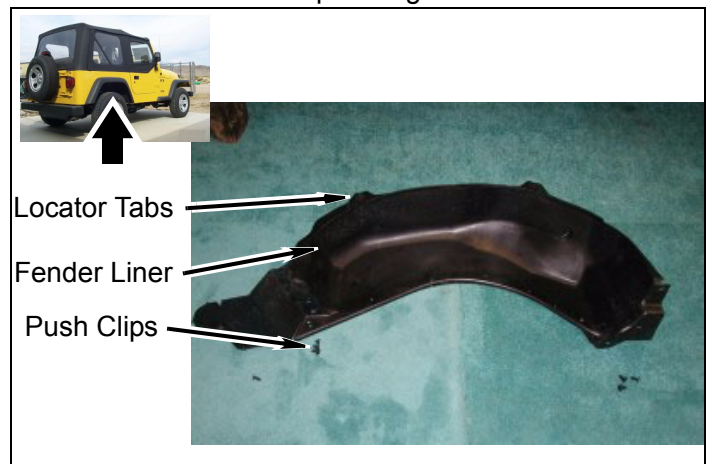

⚠WARNING

Use extreme caution when working near fuel lines and fuel tank to avoid an explosion or fire resulting in serious personal injury and property damage.

- b. Remove four bolts, one nut, and cover plate from body and air canister assembly.

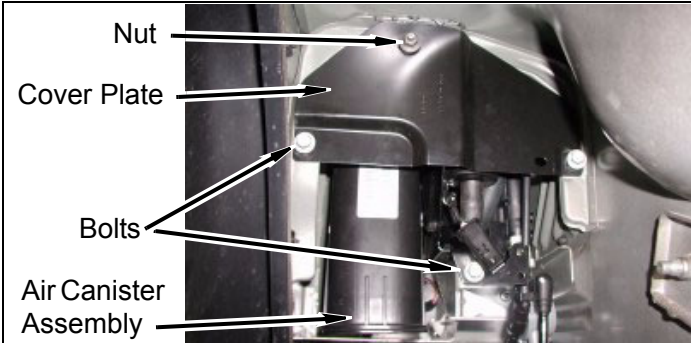

- c. Remove two wiring harness push clips and wiring harness from body and air canister assembly.
- d. Disconnect wiring harness connector from air canister assembly.

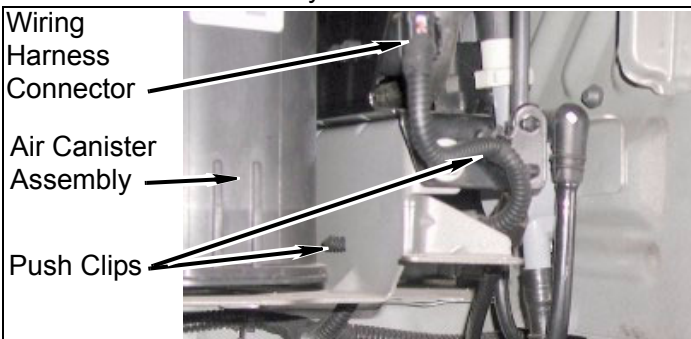

- e. Carefully slide a small and large clip outward and remove a small and large vent line from air canister assembly and vehicle.

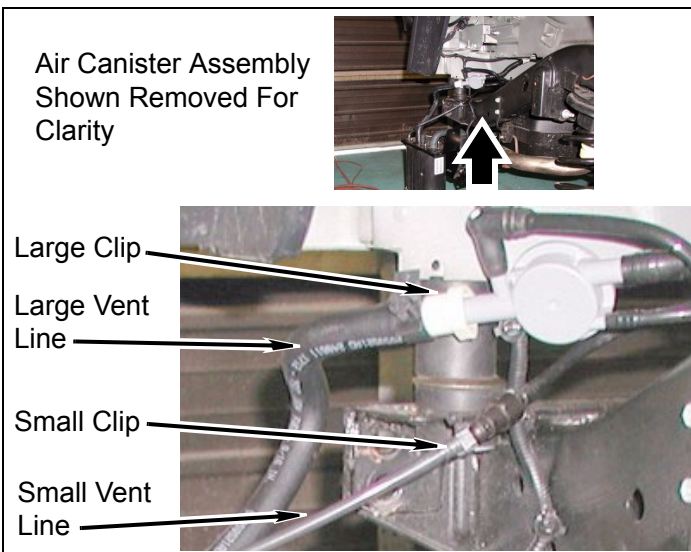

7. Passenger taillight assembly.

- a. Disconnect taillight wiring harness clip from taillight wiring harness.

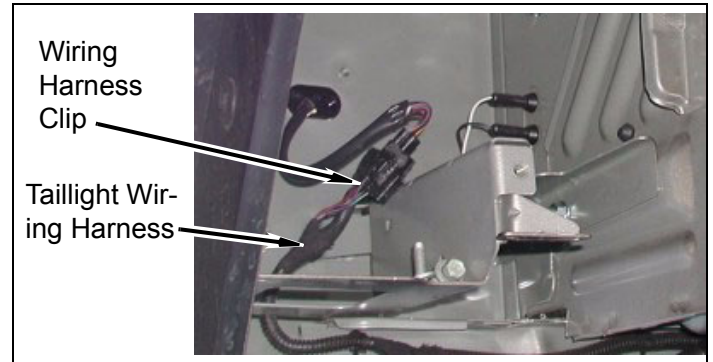

- b. Remove four screws and taillight lens from taillight assembly.
- c. Remove four screws and taillight assembly from body.

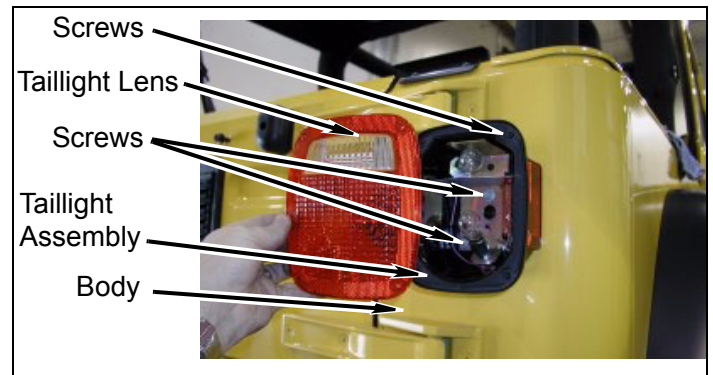

8. Rear seat belts.

- a. Remove two torx bolts and two seat belt retractors from sport bar driver and passenger side. T50 torx used here.

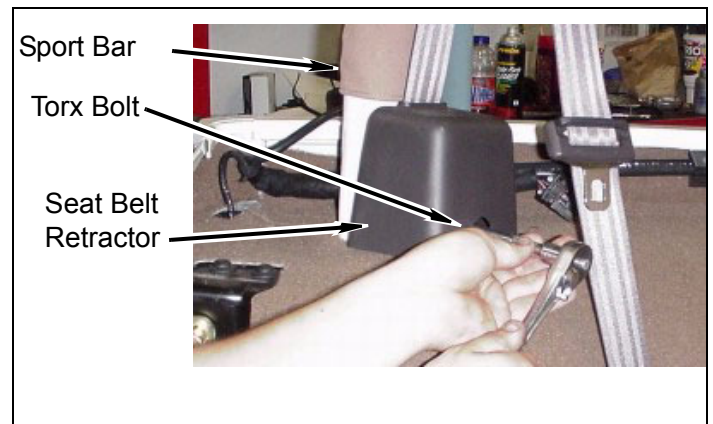

- b. Lift and push carpet from wheel well, cargo area, and sport bar toward back seat.

9. Sport bar rear mounts.

△NOTE

A hobby knife makes a perfect cut for separating the body paint and the hinge bolts.

- a. Remove four T45 torx bolts from sport bar rear mounts and body.

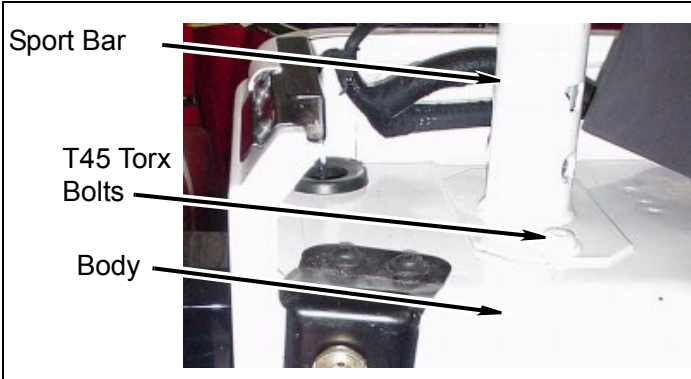

10. Tailgate striker assembly.

- a. **TJ Only:** Remove four bolts and tailgate striker assembly from body.

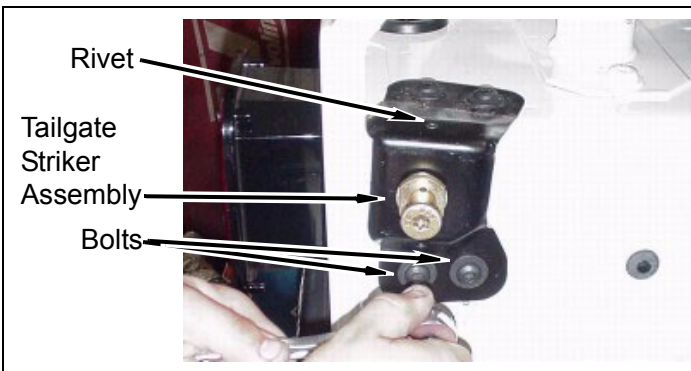

- b. **YJ Only:** Remove five bolts and tailgate striker assembly from body.

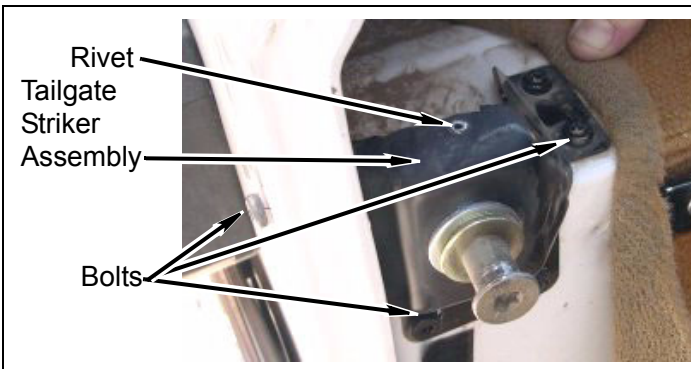

- c. **All Models:** Drill rivet, and remove striker post, shims, and flat nut from tailgate striker bracket.

Install the kit

- 1. Kit reinforcement bracket driver side.

- a. Position kit **driver side reinforcement bracket** on body, around and on top of sport bar.

△WARNING

Ensure kit reinforcement brackets are snug up against back body wall. It may be necessary to trim body putty and excessive paint from the corners of body joints. Ensure that the sport bar is not propping up the kit reinforcement brackets.

- b. Install kit **driver side reinforcement bracket** and sport bar on body with two T45 torx bolts. Do not tighten.
- c. Install kit **driver side reinforcement bracket** on body with four torx bolts.

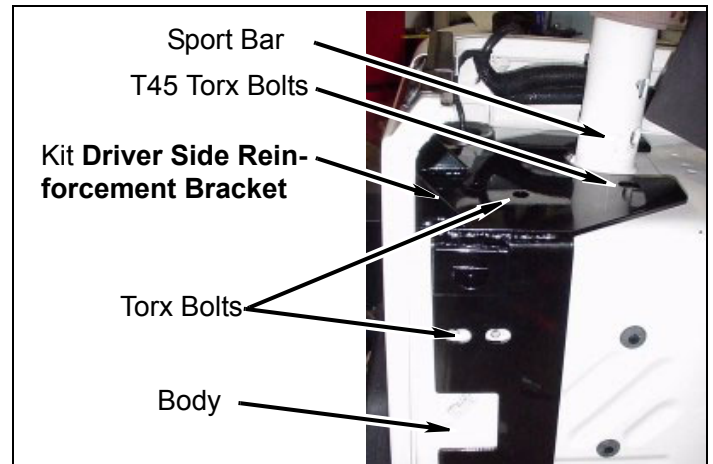

- d. Using kit **driver side reinforcement bracket** as a template, mark the back body wall with center punch as shown.

- e. Drill a 1/8" pilot hole where marked. Enlarge pilot hole with 7/16" drill bit.

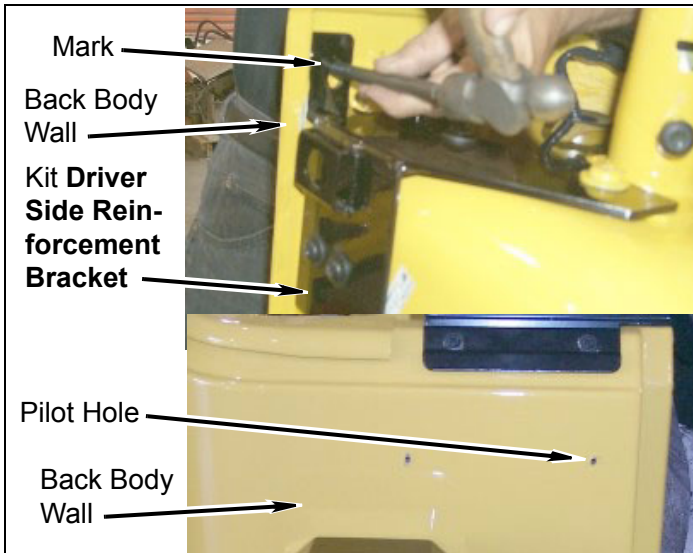

- f. Install kit **striker plate** on back body wall and kit **reinforcement bracket** with a kit **bolt** (3/8" x 1") and a kit **flange nut** (3/8"). Snug bolt but do not tighten.

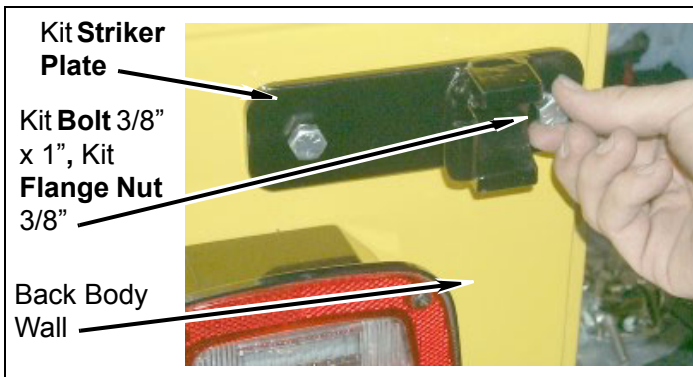

- g. Using kit **striker plate** as a template mark the back body wall with center punch as shown.

- h. Drill a 1/8" pilot hole where marked. Enlarge pilot hole with 7/16" drill bit.

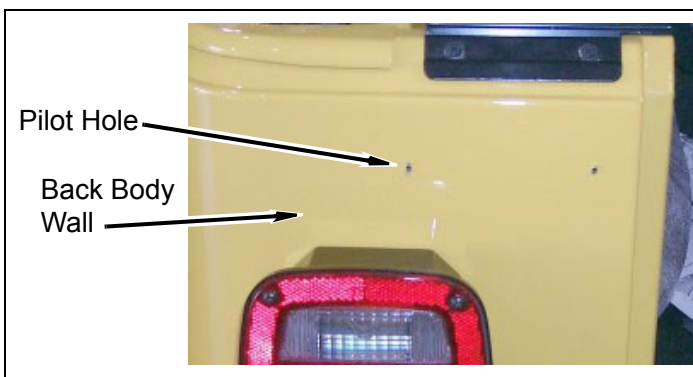

- i. Install kit **striker plate** on back body wall and kit **reinforcement bracket** with a kit **bolt** (3/8" x 1") and a kit **flange nut** (3/8"). Tighten six torx bolts and two kit **bolts** (3/8" x 1").

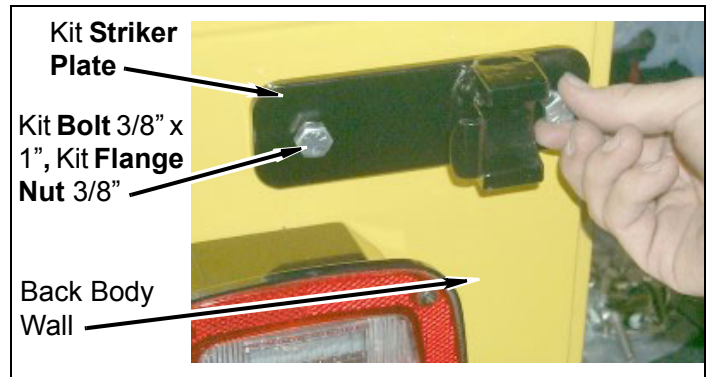

- j. Using kit **driver side reinforcement bracket** as a template, mark the wheel well with center punch as shown.

- k. Drill 1/8" pilot holes where marked. Enlarge pilot holes with 7/16" drill bit.

- l. Install kit **driver side reinforcement bracket** on wheel well with two kit **bolts** (3/8" x 1") and two kit **flange nuts** (3/8"). Snug bolt but do not tighten.

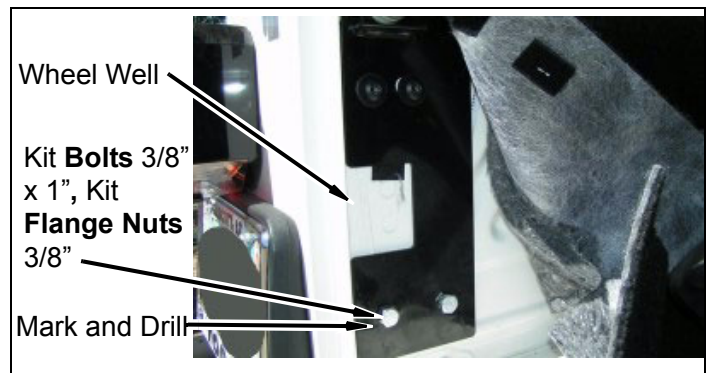

- m. **YJ ONLY:** Install kit **driver side reinforcement bracket** on body with kit **bolt** (1/4" x 1") and **square nut** (1/4").

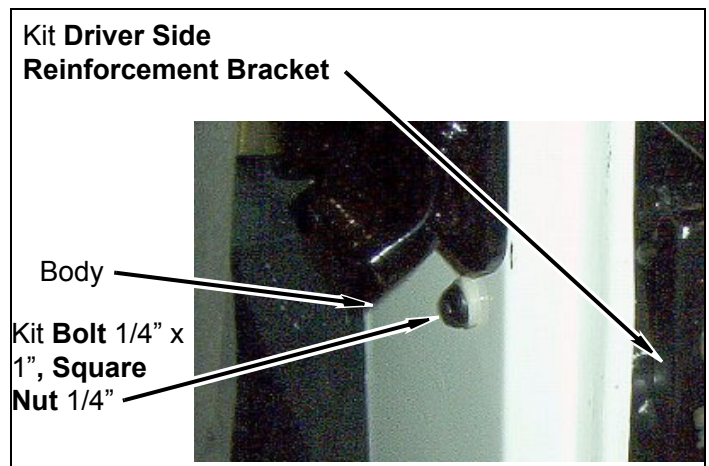

2. Tailgate striker post.

NOTE

In the step below there is adjustment for the striker post with the factory shims. You may want to adjust the factory shims for the desired result when the tailgate is fully installed.

- a. Position the flat nut on kit **driver side reinforcement bracket**. Install striker post and shims on kit **driver side reinforcement bracket** with the flat nut.

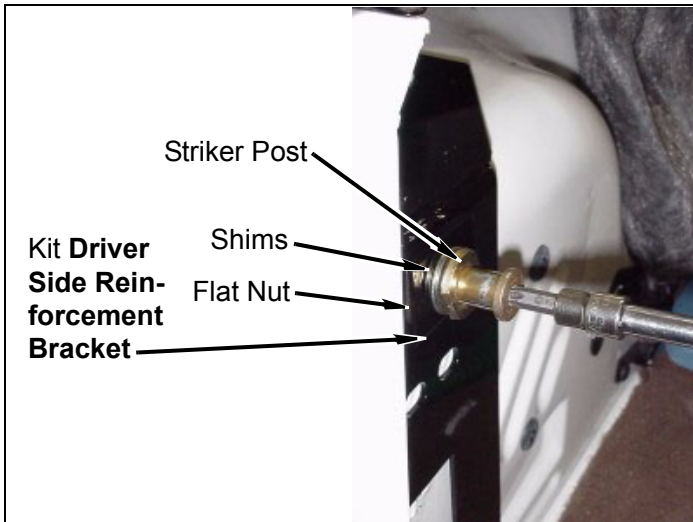

3. Kit reinforcement bracket passenger side.

NOTE

2004 Models: It is best to drill out the two top captive nuts with a gradual progression of larger bits until the two top nuts are removed.

- a. **2004 Models:** Drill out two top captive nuts from upper body/hinge area only. The final drill bit size should be 5/8".

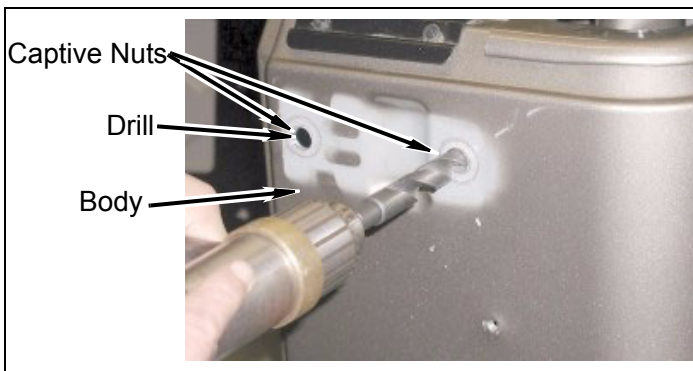

- b. Position kit **passenger side reinforcement bracket** on body.

WARNING

Ensure kit reinforcement brackets are snug up against back body wall. It may be necessary to trim body putty and excessive paint from the corners of body joints. Ensure that the sport bar is not propping up the kit reinforcement brackets.

- c. Install kit **passenger side reinforcement bracket** and sport bar on body with two torx bolts. Do not tighten.

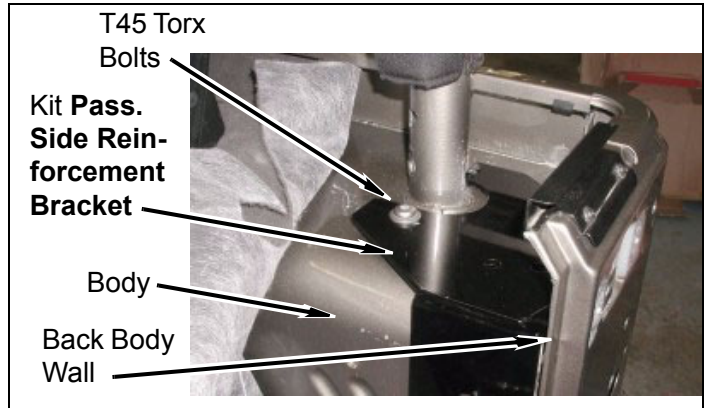

- d. Using kit **passenger side reinforcement bracket** as a template, mark the wheel well with center punch.

- e. Drill 1/8" pilot holes where marked. Enlarge pilot holes with 7/16" drill bit.

- f. Install kit **passenger side reinforcement bracket** on wheel well with two kit bolts (3/8" x 1"), two kit washers (3/8 USS), and two kit flange nuts (3/8"). Snug two kit bolts and two torx bolts but do not tighten.

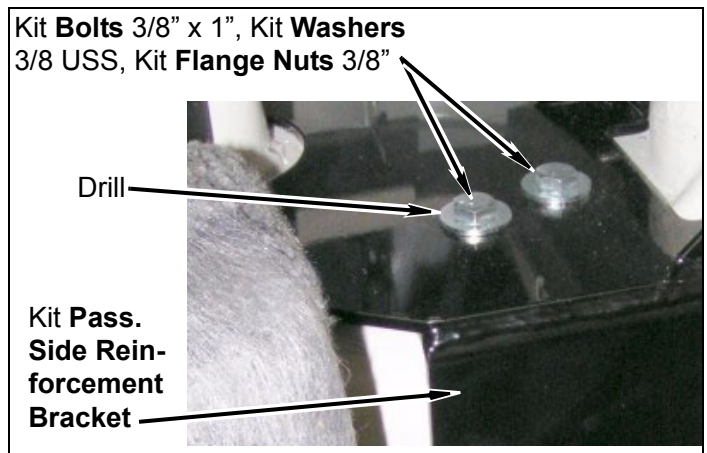

- g. Position kit **hinge bracket**, tailgate, and hinges on body at the same time. Snug but do not tighten bolts at this time.

Cast Aluminum Hinge:

Install four kit **bolts** (5/16" x 1 1/2" allen head) and four kit **nuts** (5/16" flange).

Stamped Steel Hinge:

Install four kit **bolts** (5/16" x 1 1/4"), four kit **washers** (5/16" USS) and two kit **nuts** (5/16" flange).

- i. **TJ Models:** Install kit **hinge bracket** on body with a kit **bolt** (3/8" x 1"), kit **thick washer** (1/2"), and a kit **flange nut** (3/8"). Snug but do not tighten bolts at this time.

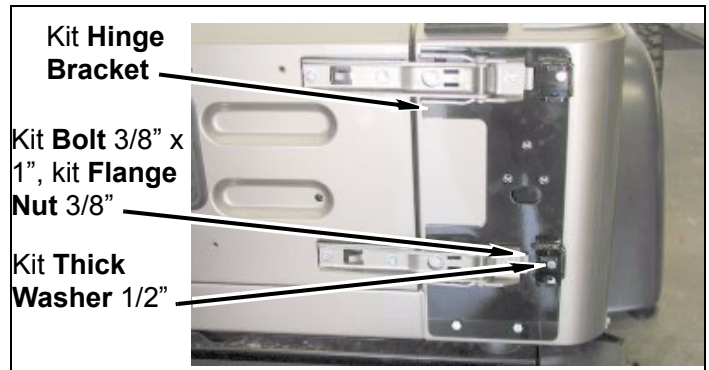

- m. **TJ Models:** Install kit **hinge bracket** and kit **small bracket** on body with two kit **bolts** (3/8" x 4") and two kit **flange nuts** (3/8"). Snug but do not tighten bolts at this time.

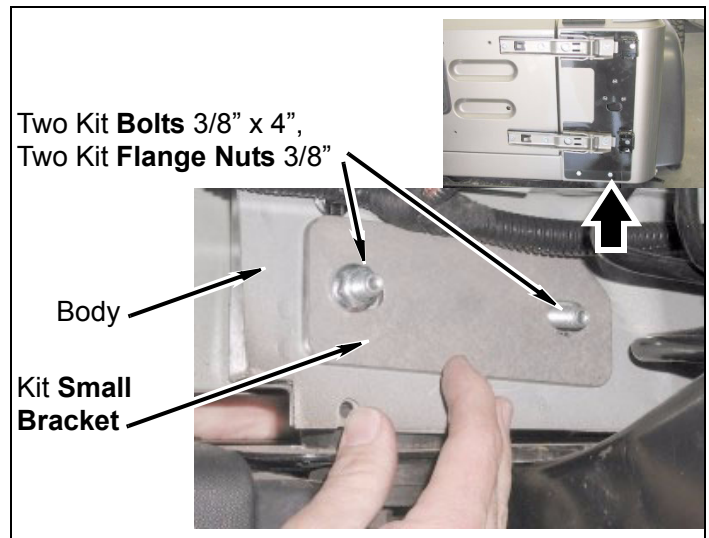

- n. **YJ Models:** Install kit **lower support bracket** on body and kit **hinge bracket** with two kit **bolts** (3/8" x 1") and two kit **flange nuts** (3/8"). Do not tighten.

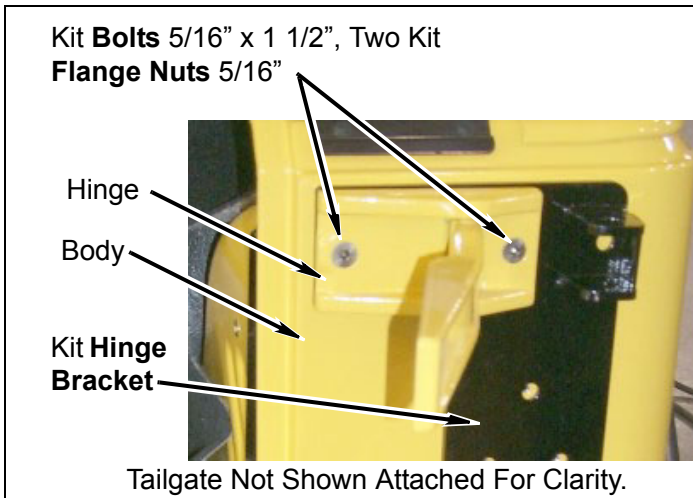
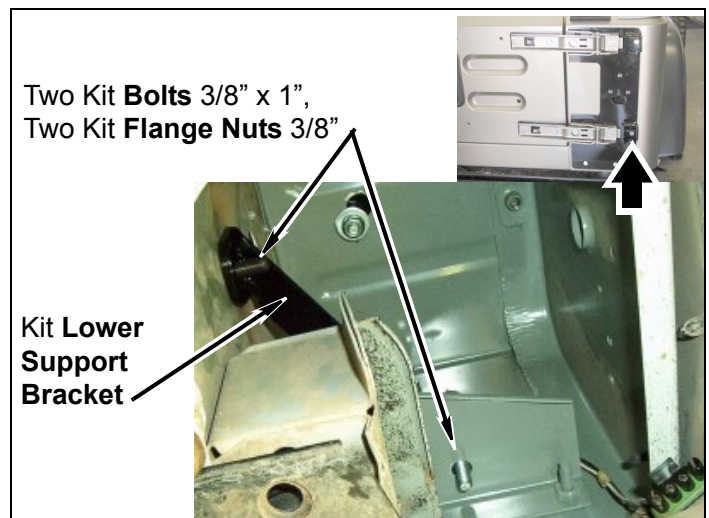

- h. Adjust tailgate, striker post, and hinges to align tailgate and provide smooth operation. Snug but do not tighten bolts at this time
- i. Using kit **hinge bracket** as a template, mark body with center punch in four places as shown.
- j. Drill four 1/8" pilot holes where marked. Enlarge pilot holes with 7/16" drill bit. On the bottom two holes drill through body cross member.
- k. Install kit **hinge bracket** on body and kit **passenger side reinforcement bracket** with a kit **bolt** (3/8" x 1") and a kit **flange nut** (3/8"). Do not tighten.

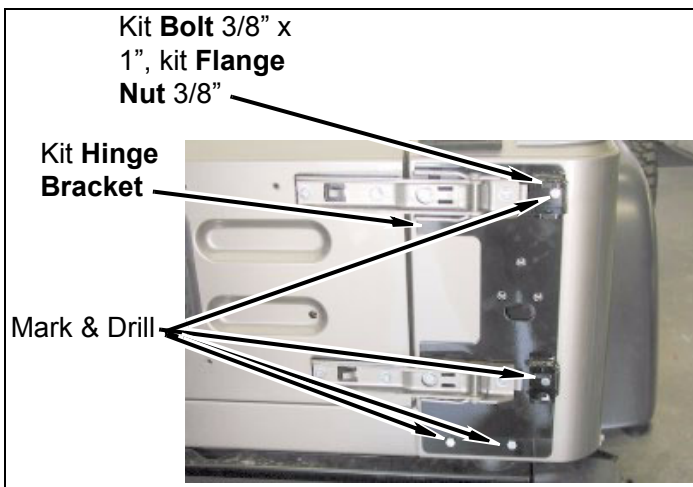

- o. Using kit **passenger side reinforcement bracket** as a template, mark wheel well with center punch as shown.
- p. Drill four 1/8" pilot holes where marked. Enlarge pilot holes with 7/16" drill bit.
- q. Install kit **passenger side reinforcement bracket** on wheel well with four kit **bolts** (3/8" x 1"), two kit **washers** (3/8 USS), and four kit **flange nuts** (3/8").

- c. Install two wiring harness push clips and wiring harness on body and air canister assembly.
- d. Connect wiring harness connector on air canister assembly.

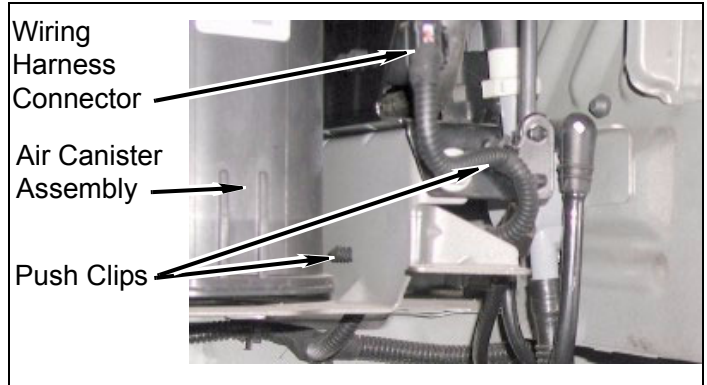
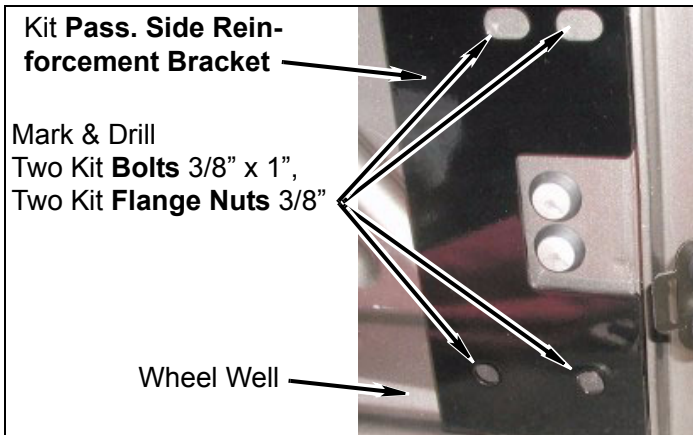

- e. Install cover plate on body and air canister assembly with four bolts and one nut.

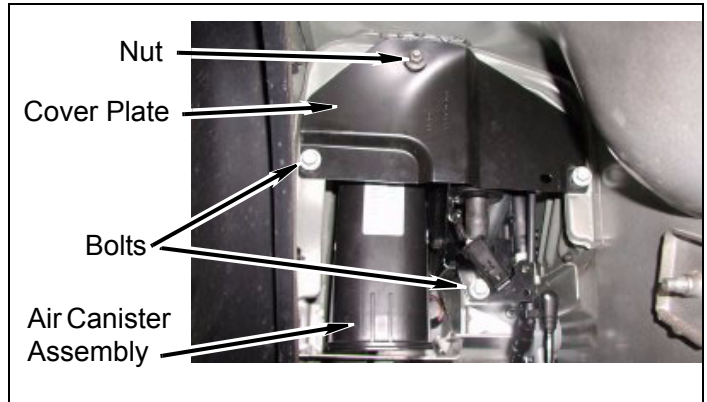

- f. Install fender liner on passenger side rear wheel well with seven push clips and two locator tabs.

4. **2003-2006:** Inner fender and air canister.

- a. Connect taillight wiring harness clip on taillight wiring harness.

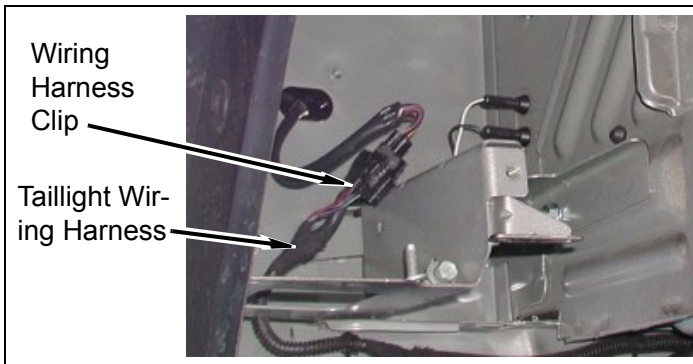

- b. Position the air canister assembly on the vehicle. Carefully install a small clip and a large clip on the small vent line and the large vent line.

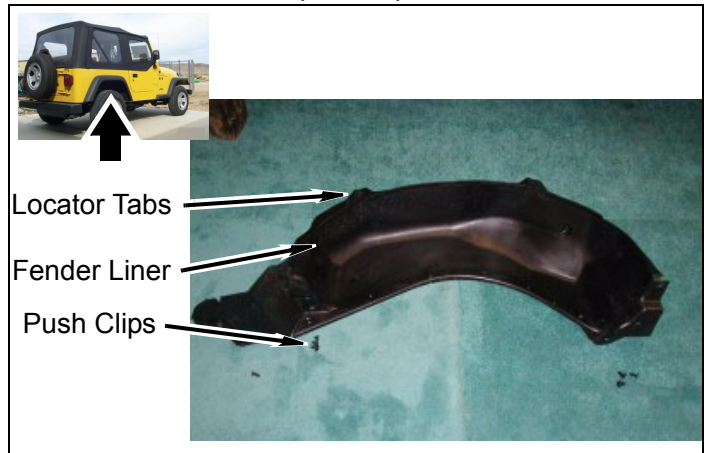
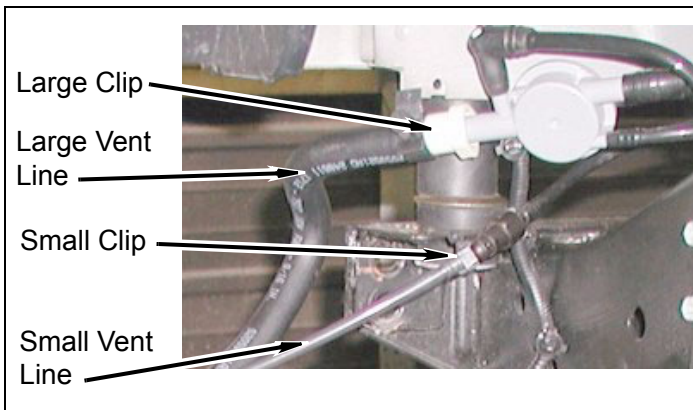

- g. Passenger taillight assembly.
- h. Install taillight assembly on body with four kit **bolts** (#12 x 3/4").
- i. Install taillight lens on taillight assembly with four screws.

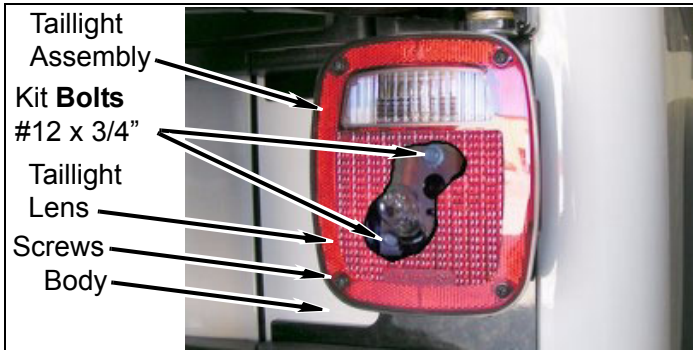

5. Tire carrier.

CAUTION
 In the step below you may need to slightly modify the length of the upper kit 1/2" x 2 3/4" bolt so that it will not hit the top of the taillight housing. The brass washers are positioned one above and two below the kit tire carrier legs.

- a. Install kit **tire carrier** on kit **hinge bracket** with two kit **bolts** (1/2" x 2 3/4"), six kit **washers** (1/2" brass), four kit **washers** (1/2" USS), and two kit **nuts** (1/2" locking). Do not tighten.

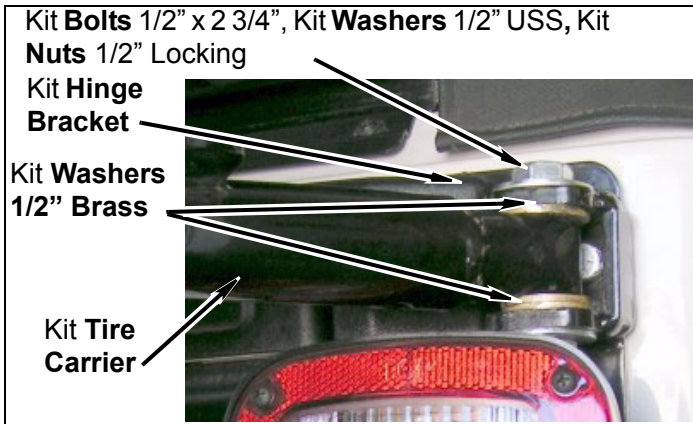

- b. **2004 models:** Install four upper and lower plastic covers on the tailgate side of hinges.

Finish the installation

1. Adjust kit **tire carrier**.

NOTE
 In the step below it may be necessary, depending on your wheel and tire combination, to slightly align the tire carrier so that it hits above the striker plate cup. This is to allow for tire weight and tire carrier flex.

- a. Align the kit **tire carrier** with the striker plate. Check to see if kit **tire carrier** closes and alignment is correct. If the alignment is not correct loosen and adjust the kit **hinge plate**. Once alignment is achieved tighten hinge bolts, tailgate bolts, and kit **bracket bolts**.

2. Rear seat belts.

- a. Position the carpet from wheel well, cargo area, and sport bar back to its original location.

NOTE
 In the step below it is necessary to hold the seat belt retractors in there installed orientation so the seat belt will release from the seat belt retractors.

- b. Install two seat belt retractors with two torx bolts on sport bar driver and passenger side. T50 torx used here.

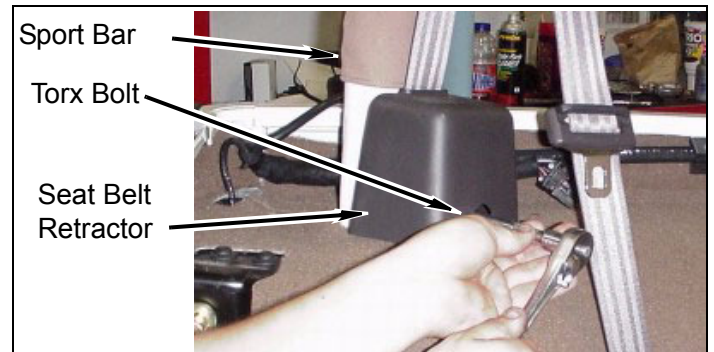

- c. Check tailgate alignment and adjust tailgate striker post as necessary.

△NOTE

In the step below, the third light has not been installed. Check your local laws and or the accessories list at the back of the instructions if you would like to install a third light on your vehicle.

- d. Install cover on open tailgate with screw.

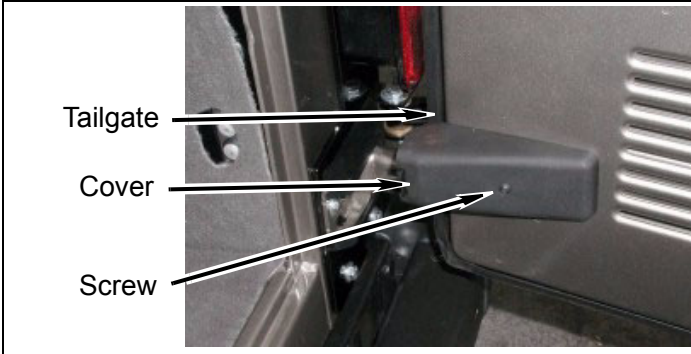

3. Tire mounting.

△WARNING

The load rating for these tire-can/tire carriers is a **MAXIMUM** of **200lbs**. Please be aware that some tire and wheel combinations along with gas cans and hi-lift jacks can **exceed** this **MAXIMUM** rating.

- a. Install kit **lock bar** on kit **tire carrier** with two kit **bolts** (5/16" x 1") and two kit **flange nuts** (5/16").
- b. Position and install tire and wheel assembly on kit **tire carrier** with kit **urethane spacer**, kit **aluminum plate**, and kit **T-bar**.

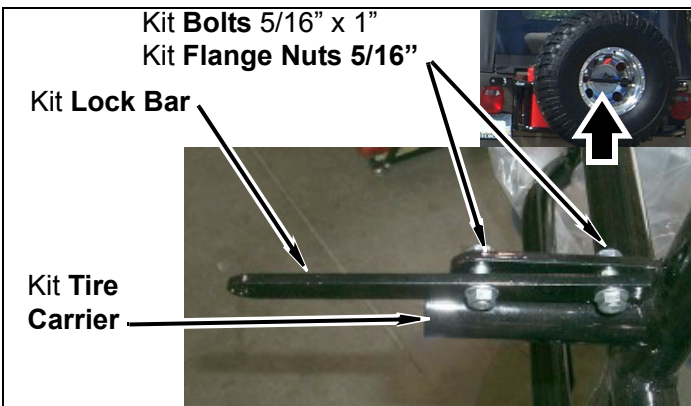

4. Kit bump-stop.

△CAUTION

In the step below you may need to slightly grind the face of the kit **lower bump-stop** so that it will not dent the tailgate. When adjusted properly the kit **lower bump-stop** should just touch the tailgate and the kit **2" x 2" stainless stick pad**.

- a. Install the kit **lower bump-stop** on the kit **tire carrier**.
- b. Use the location of the kit **lower bump-stop** on the tire carrier to position the kit **2" x 2" stainless steel stick pad** on the tailgate.

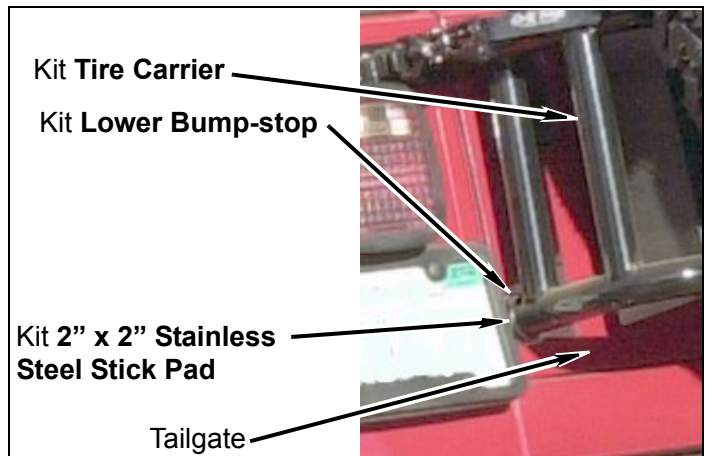

- c. **Tire-can carrier only:** Install your gas cans on tire-can carrier using the bottom lip of the cans along with two kit **threaded rods** (3/8 x 8"), kit **L-brackets** and kit **wing nuts** as shown.

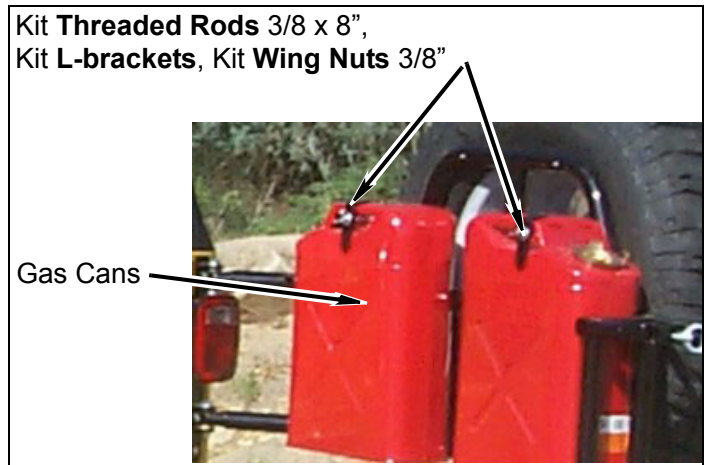

Accessories

The following accessories are also available:

Kit # 87013: No n-lip can carrier adapter.

Kit # 87017: TJ third light kit for tire-can carrier.

Parts list

<u>QTY</u>	<u>Description</u>
1	Pad , 2" x 2" Stainless Steel Stick
1	Plate , Alum inum
4	Bolt , #12 X 3/4"
2	Bolt , 1/2" x 2 3/4"
13	Bolt , 3/8" x 1"
8	Bolt , 5/16" X 1 1/2" Allen Head
8	Bolt , 5/16" X 1 1/4"
2	Bolt , 5/16" x 1"
1	Brac ket, Driver Side Reinforcement
13	Nuts, Flange 3/8"
6	Nuts, Flange 5/16"
1	Brac ket, Hinge
1	Lower Bump-stop
2	Nuts, 1/2" Locking
1	Brac ket, Passenger Side Reinforcement
1	Plate , S triker
2	Plates , Tailgate Hinge
1	S pacer , Urethane
1	Tire Carrier
8	Wa sher , 5/16" USS
6	Wa shers , 1/2" Brass
4	Wa shers , 1/2" USS
4	Washers, 3/8" USS
1	T- Bar
1	Loc k Bar
TJ / TJL ONLY	
1	Brac ket, Small
2	Bolt , 3/8" x 4"
2	Nuts, Flange 5/16"
2	Nuts, Flange 3/8"
1	Wa sher , Thick 1/2"
YJ ONLY	
1	Bolt , 1/4" x 1"
1	Nut, Squa re 1/4"
1	Brac ket, Lower Support
CAN CARRIER ONLY	
2	Threaded Rods 3/8 x 8"
2	L-brackets
2	Wing Nuts 3/8"

△NOTE
Hi-lift jacks can be installed on the tire-can/tire carriers with the use of two bolts (3/8" x 1 1/2") not provided with these kits.