



3651 N. Hwy. 89 • Chino Valley, AZ 86323
(928) 636-7080

2015 CHEVY SILVERADO & GMC SIERRA 2500HD/3500HD DURAMAX DIESEL PICKUP 3" BODY LIFT INSTALLATION INSTRUCTIONS KIT #10313

⚠ WARNING

Installation of a Performance Automotive Group body lift kit will change the vehicle's center of gravity and handling characteristics both on and off-road. You must drive the vehicle safely! Extreme care must be taken to prevent vehicle rollover or loss of control, which could result in serious injury or death. Avoid sudden sharp turns or abrupt maneuvers and always make sure all vehicle occupants have their seat belts fastened.

⚠ WARNING

Before you install this kit, read and understand all instructions, warnings, cautions, and notes in this instruction sheet and in the vehicle owner's manual.

⚠ CAUTION

Proper installation of this kit requires knowledge of the factory recommended procedures for removal and installation of original equipment components. We recommend that the factory shop manual and any special tools needed to service your vehicle be on hand during the installation. Installation of this kit without proper knowledge of the factory recommended procedures may affect the performance of these components and the safety of the vehicle. We strongly recommend that a certified mechanic familiar with the installation of similar components install this kit.

⚠ WARNING

This kit should only be installed on a vehicle that is in good working condition. Before you install the kit, thoroughly inspect the vehicle for corrosion or deformation of the sheet metal around the factory body mounts. If the vehicle is suspected to have been in a collision or misused, do not install this kit. Off-road use of your vehicle with this kit installed may increase the stress applied to the factory body mounts. We do not recommend that any vehicle with a body lift kit installed be involved in any extreme off-road maneuvers such as jumping. Failure to observe this warning may result in serious personal injury and/or severe damage to your vehicle.

⚠ WARNING

Many states and municipalities have laws restricting bumper heights and vehicle lifts. Consult state and local laws to determine if the changes you intend to make to the vehicle comply with the law.

⚠ WARNING

The installation of larger tires may reduce the effectiveness of the Braking System.

⚠ WARNING

Always wear eye protection when operating power tools.

⚠ WARNING

Before you install this kit, block the vehicle tires to prevent the vehicle from rolling.

⚠ WARNING

Accidental deployment of the air bag can result in serious personal injury or death. To avoid accidental deployment during installation of the kit, the Supplemental Restraint System (SRS, or airbag) must remain deactivated. Do not allow anyone near the airbag during installation. Refer to the factory service manual or owner's manual for the recommended procedure to disable the SRS. After you install the kit, reactivate the SRS before driving the vehicle.

⚠ NOTE

Performance Automotive Group recommends using the Loctite® supplied in the kit on the threads of all kit nuts and bolts unless specified otherwise in these instructions.

Before Starting Installation

NOTE
 Kit parts are prefaced by the word **kit** and appear in **bold print**.

1. Carefully read all warnings and instructions completely before beginning.
2. Verify all parts have been received in this kit by checking the parts list at the end of this document.

NOTE
 If parts are missing from kit, please be prepared to provide the following information:

1. **Name** of purchase location
2. **Bar Code** on side of box
3. **Date** above bar code
4. **Date** inside box cover
5. **Inspector #** from inside box cover

3. **Only install this kit on the vehicle for which it is specified.** If anytime during the installation you encounter something different from what is outlined in the instructions, call technical support at (928) 636-7080.
4. Special tools needed:
 - a. Die grinder or similar tool capable of cutting metal.
5. Park the vehicle on a clean, dry, flat, level surface and block the tires so the vehicle cannot roll in either direction.

A. Engine compartment

1. Battery cables
 - a. Disconnect battery cables from both batteries. Disconnect two negative cables first, then two positive cables.

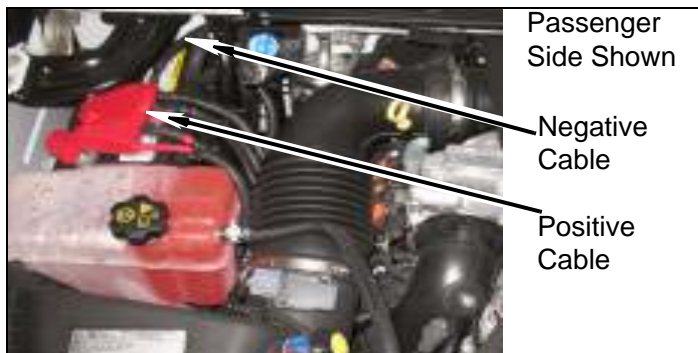

- b. Disconnect positive starter cable from battery junction as shown in image:

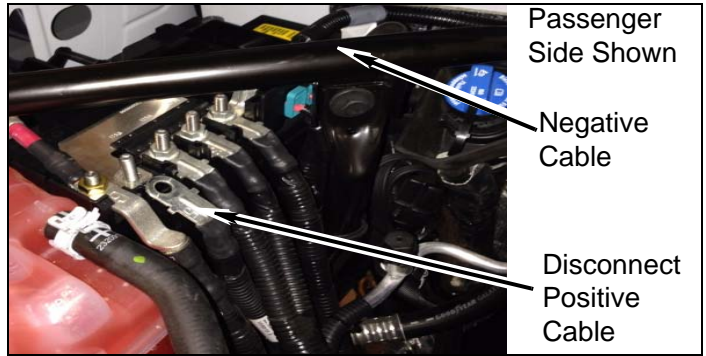

2. Airbag fuse

- a. Remove cover and airbag fuse "SIR" from fuse panel. Fuse locations may vary. Check fuse chart on back of cover.



B. Measurements

1. Measure distance between the front bumper and front fenders. Record measurement.
 Driver Side _____ Passenger Side _____
2. Measure distance between rear bumper and bed.
 Driver Side _____ Passenger Side _____
3. Measure and record distance between cab and bed both sides.
 Driver Side _____ Passenger Side _____

Prepare to install kit.

A. Front of vehicle

1. Grille

a. Remove cover from core support with ten push pins.

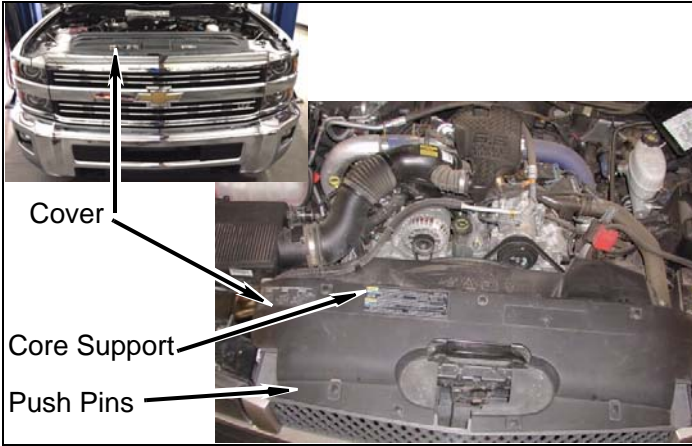

b. Remove four bolts from top of grille and disconnect lower grille clips from core support to remove grille.



2. Front bumper

a. If equipped, disconnect front bumper wire harness connector, near center of bumper.

b. Remove six bolts and two front outer bumper braces from front bumper and frame.

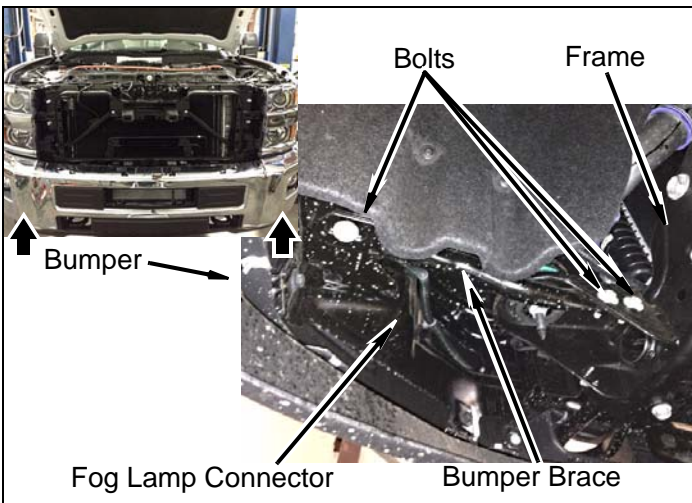

c. Remove four bolts from frame horn brackets.

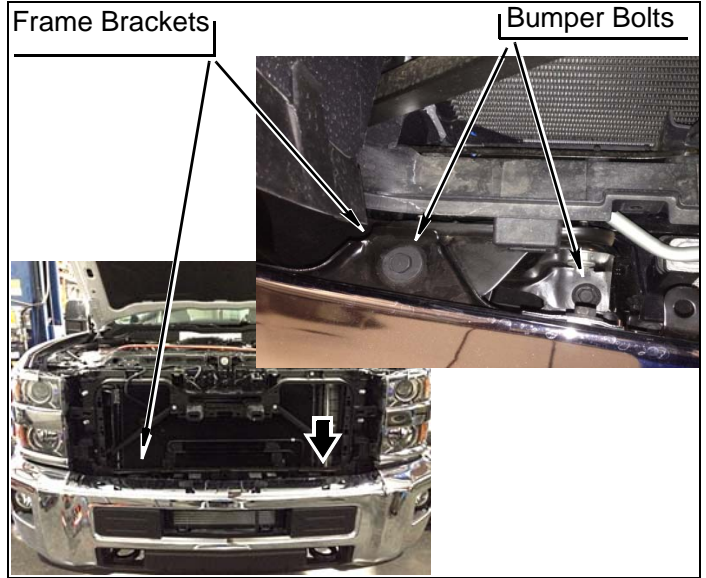

d. Remove front bumper from frame horns.

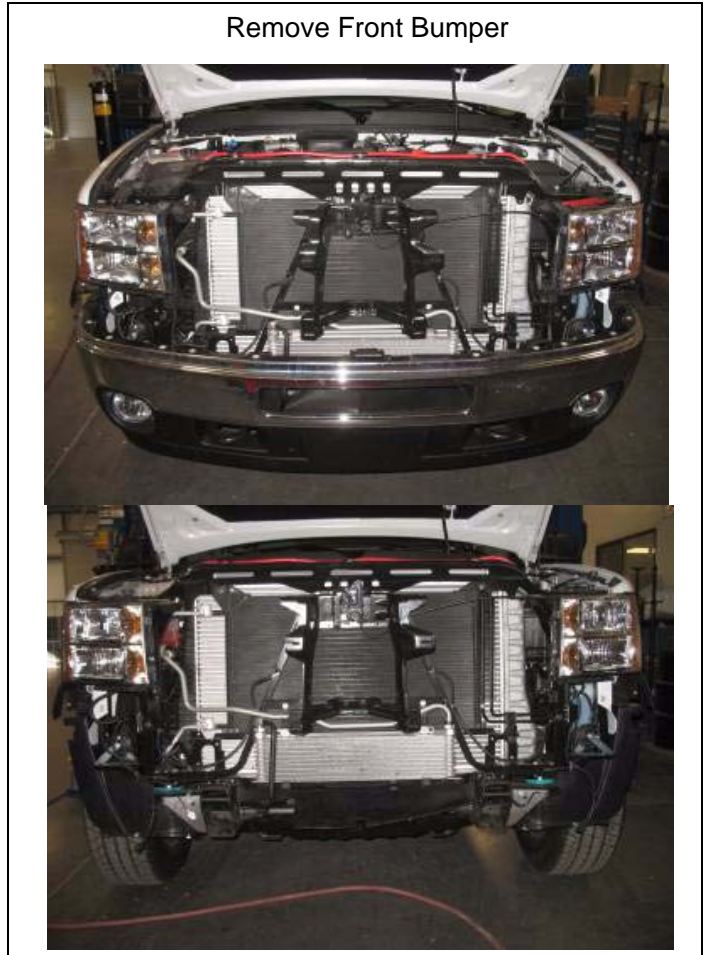

e. Remove eight bolts from front frame horn brackets and remove both front bumper brackets from frame horns.

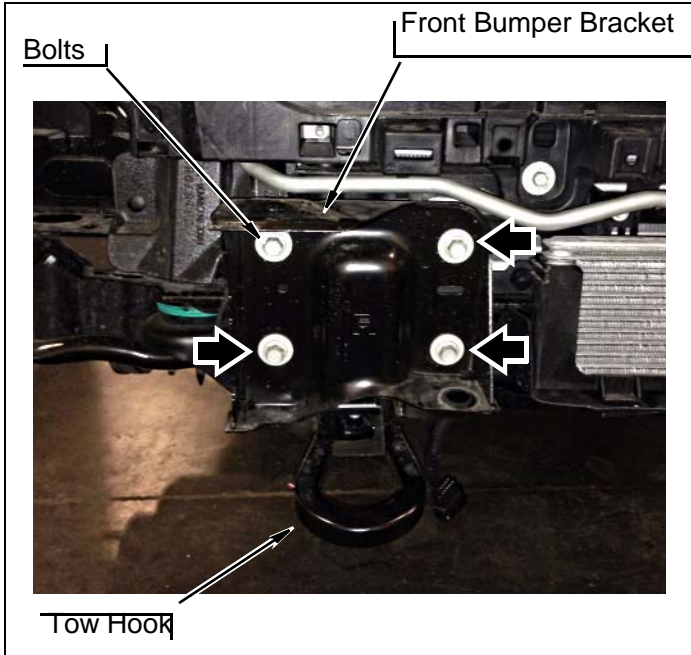

f. Remove four bolts, two nuts and two tow hooks from frame horns.

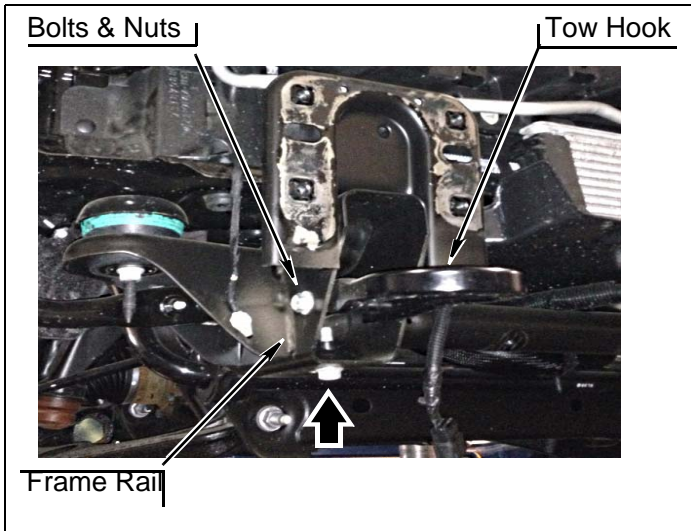

3. Plastic cover and air flap

a. Remove five bolts, and plastic cover from frame and core support.

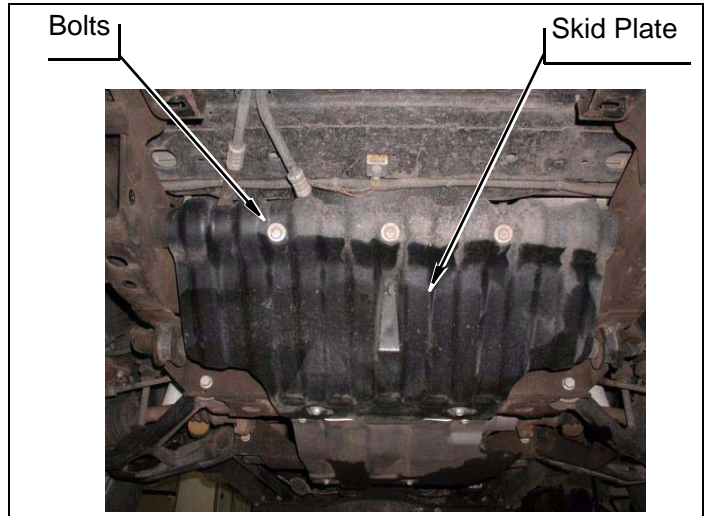

b. Remove plastic cover from push clip, lower radiator hose and vehicle.

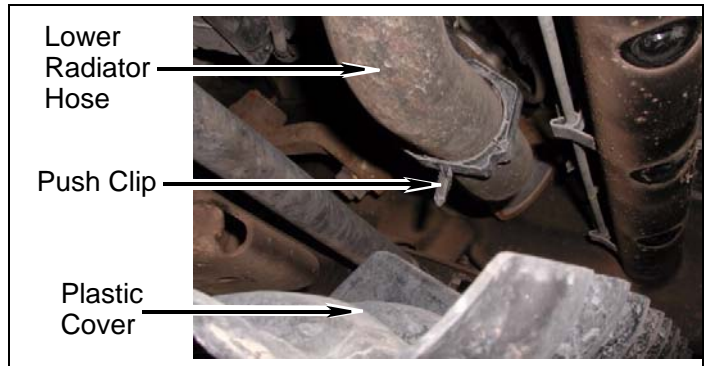

c. Remove push pins and air flap from core support.

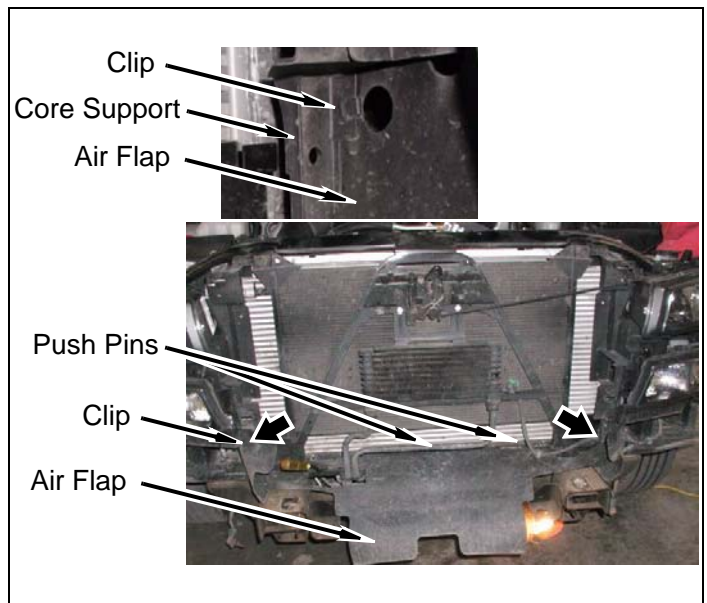

B. Engine Compartment

1. Air intake

- a. Loosen clamp from air baffle assembly. Remove wire harness clip from sensor.

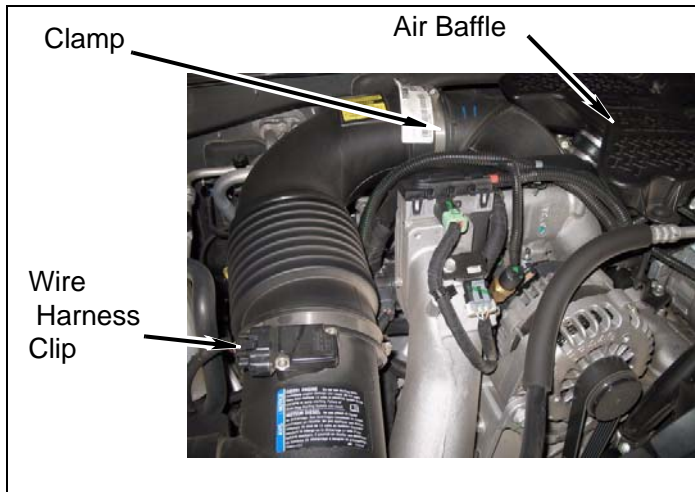

- b. Rotate air intake assembly away from engine and towards fender while pulling the air box up and out of rubber grommets on fender.

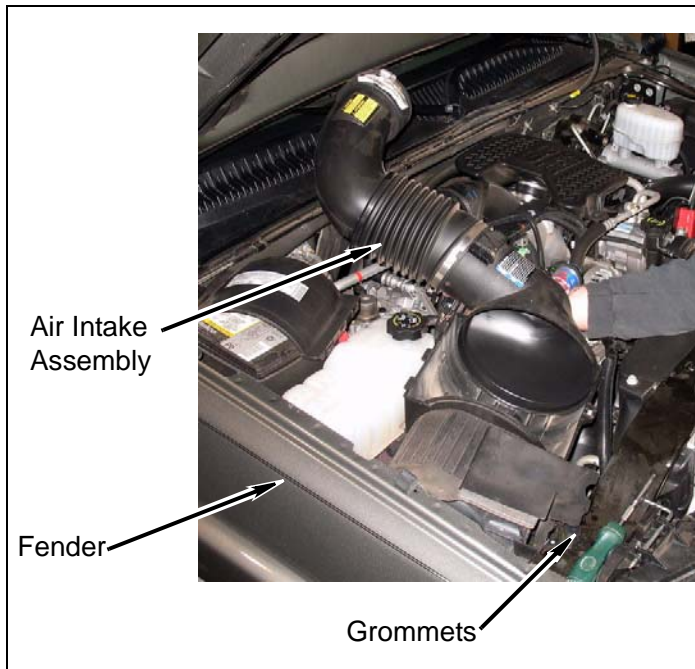

- c. Remove A/C hose from clip on upper fan shroud.

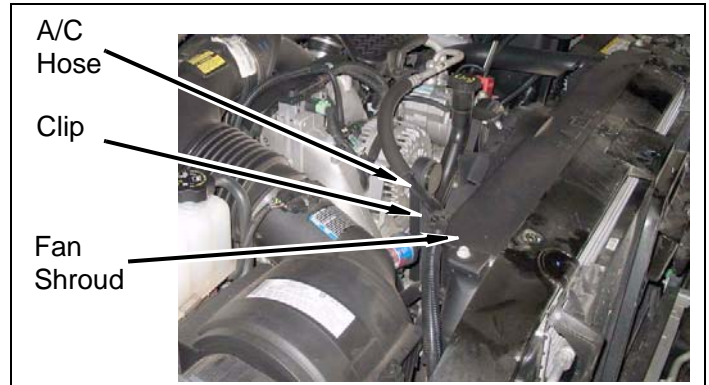

2. Fan shroud

- a. Remove two push clips and computer from upper fan shroud.

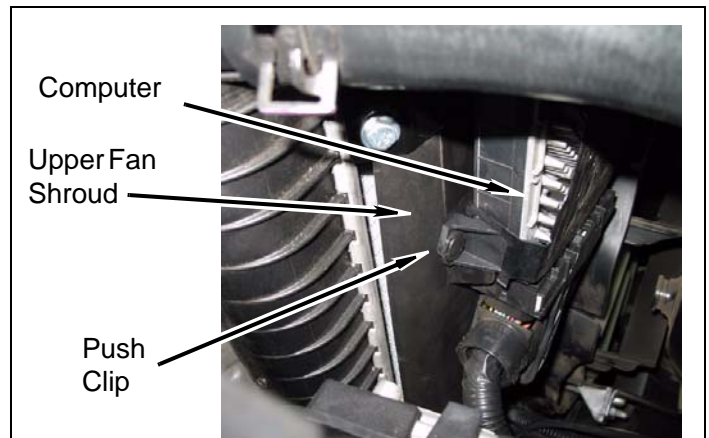

CAUTION

Do not disconnect wiring harnesses from computer module.

- b. Lift up and back to remove computer module from fan shroud. Rest assembly on power steering belt/pump.

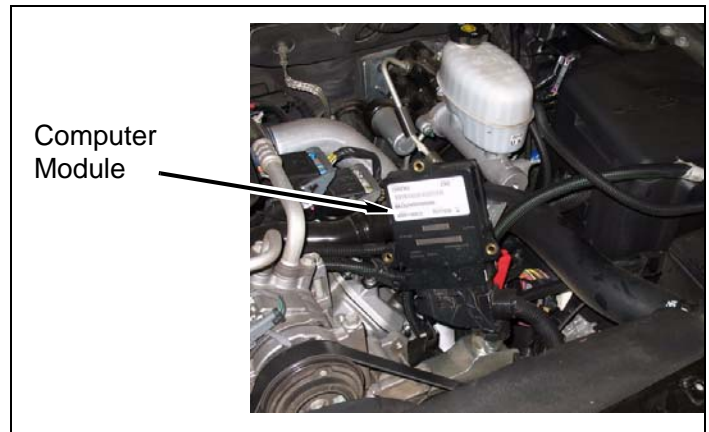

c. Remove four fan shroud push clips(12) from main(10) and secondary(11).

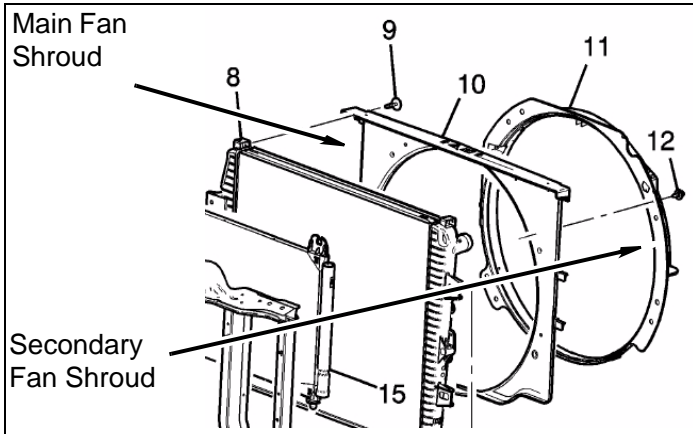

d. Remove four bolts from fan cage around front of engine.

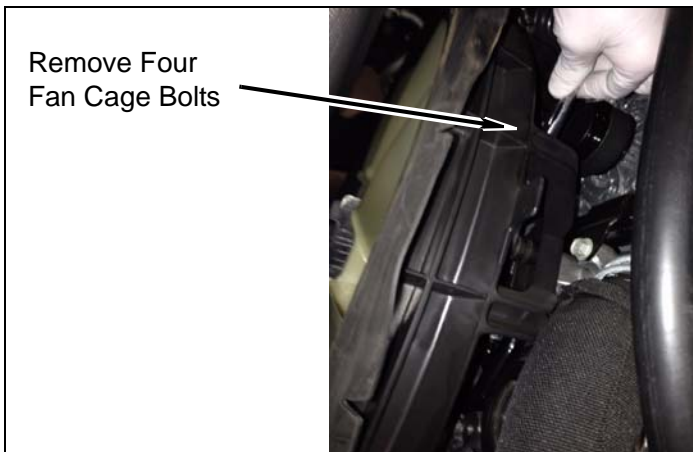

e. **Using fan clutch removal tool set, loosen and remove fan clutch from water pump pulley.

f. Disconnect fan clutch harness.



g. Remove fan/clutch, fan cage and secondary fan shroud as one assembly from vehicle.

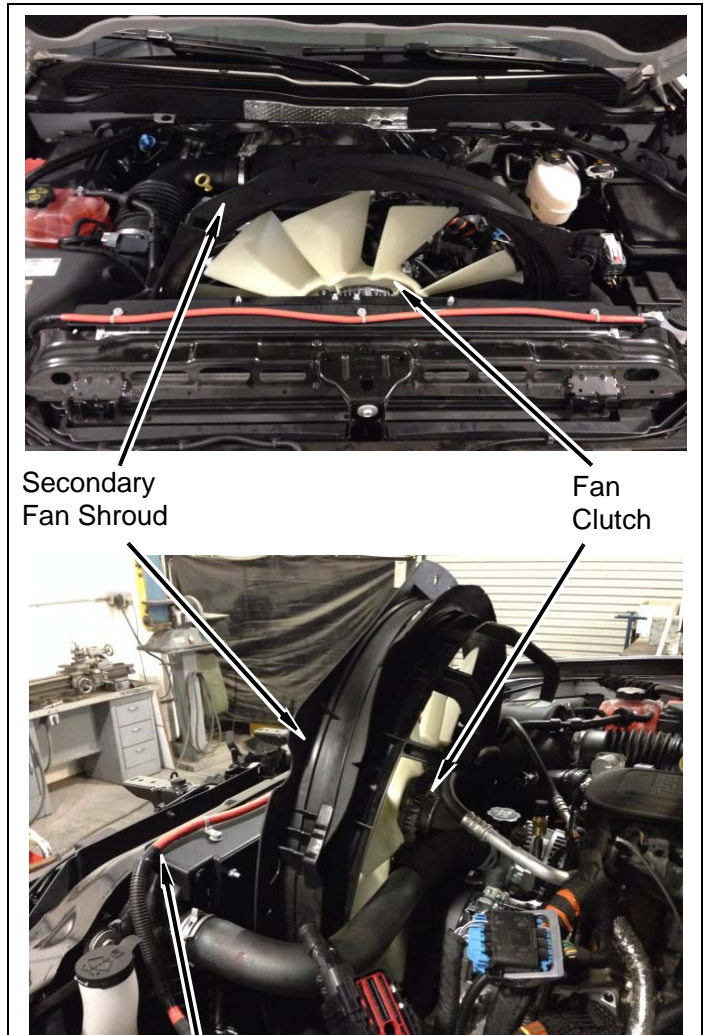

h. Remove positive battery cable from top of main fan shroud.

i. Remove two push clips from main fan shroud on right and left sides upper radiator and carefully remove the main fan shroud from vehicle.

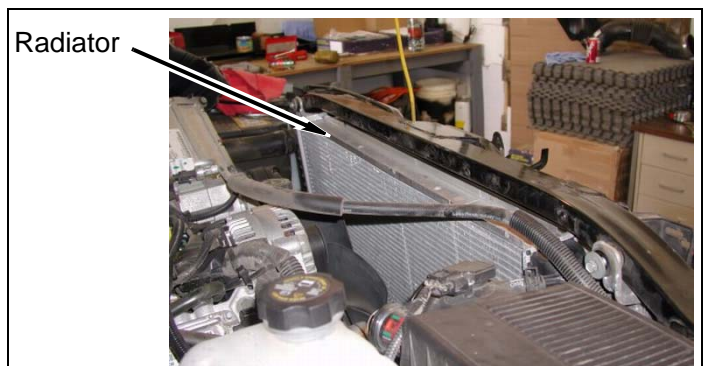

3. Intercooler piping passenger side

- a. Remove wire clip from upper intercooler pipe at engine intake manifold. Twist hose clamp ring at upper end of intercooler hose to disconnect hose from throttle body.

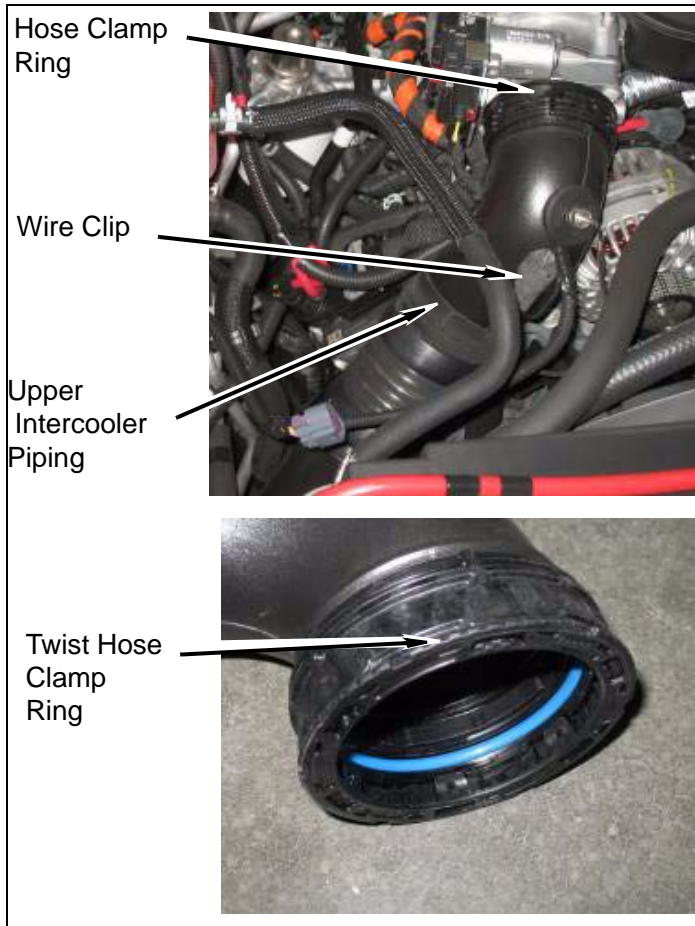

- b. Remove Lower intercooler pipe and hose from vehicle by twisting ring clip.

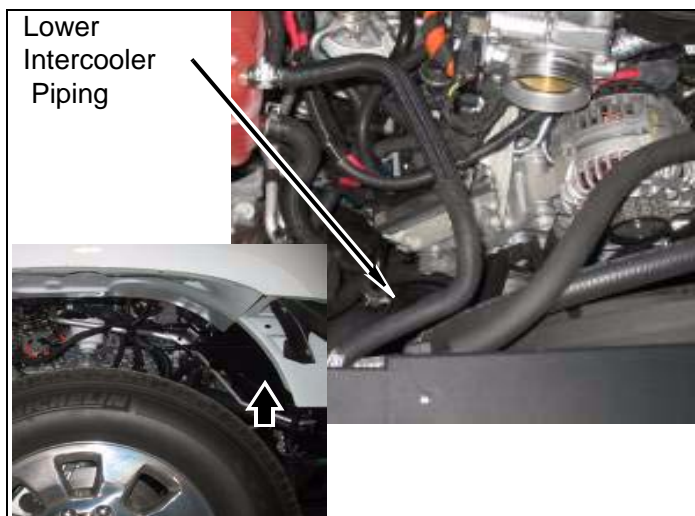

- c. Remove clip and harness from engine mounted bracket.

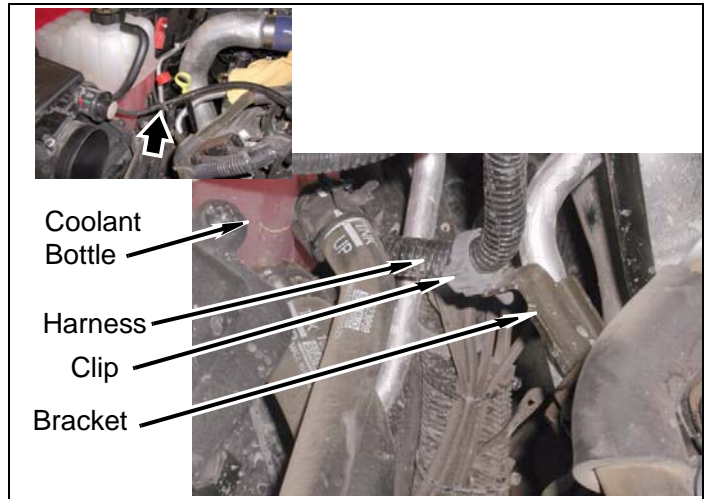

4. Intercooler piping drivers side

- a. Loosen clamp, silicone hose, and intercooler hose from engine side. Do not remove.

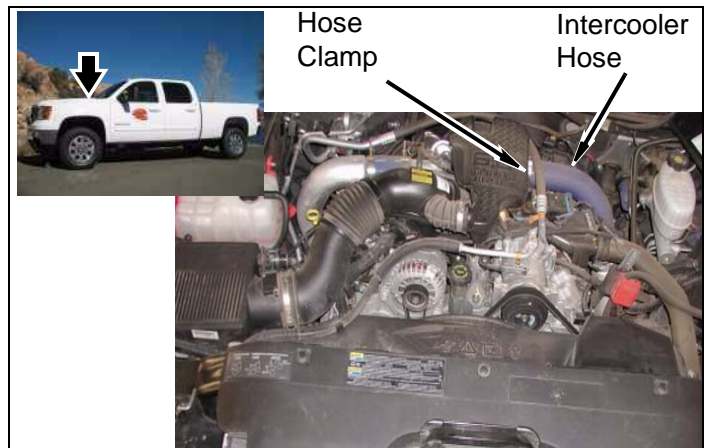

5. Steering shaft

NOTE
 Ensure steering shaft does not turn independently of the steering gearbox. This could cause the air bag system to malfunction, resulting in serious personal injury or damage to the equipment.

- a. Straighten steering wheel and strap the wheel so it will not turn.

b. Remove bolt and nut from upper and lower steering shaft.

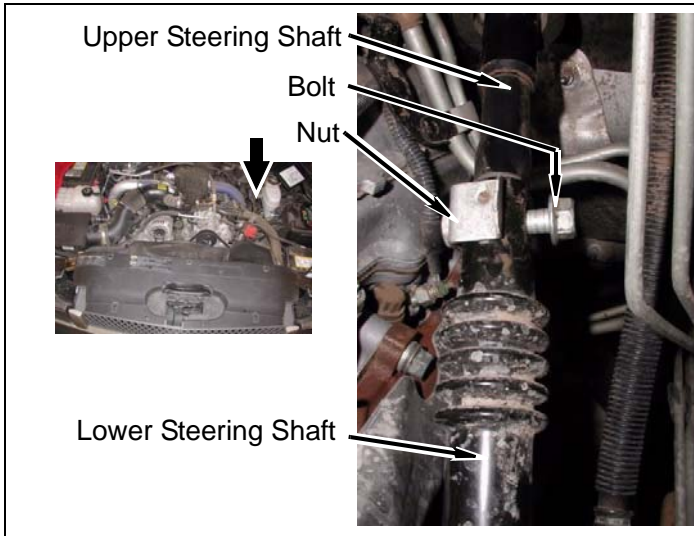

c. Slide upper steering shaft up to separate from lower steering shaft.

6. Wiring harnesses and ground strap

a. Remove nut and ground strap from stud on fire wall.

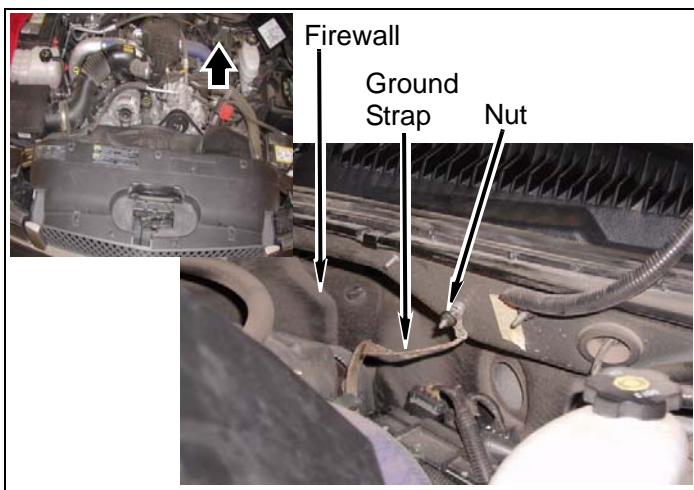

b. Remove harness from clip and bracket.

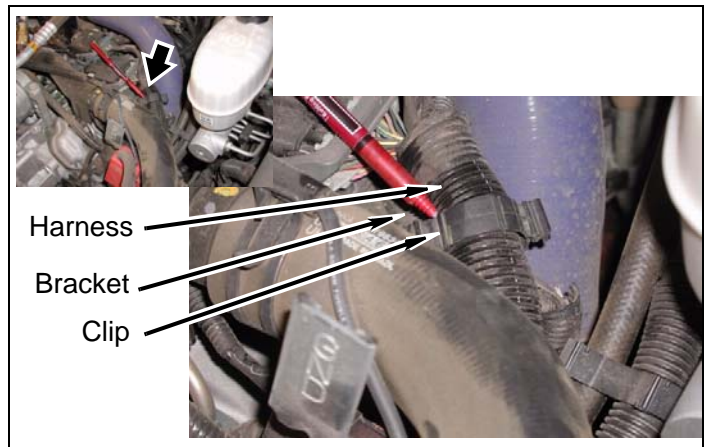

c. Remove two clips and harness from cover and inner fender.

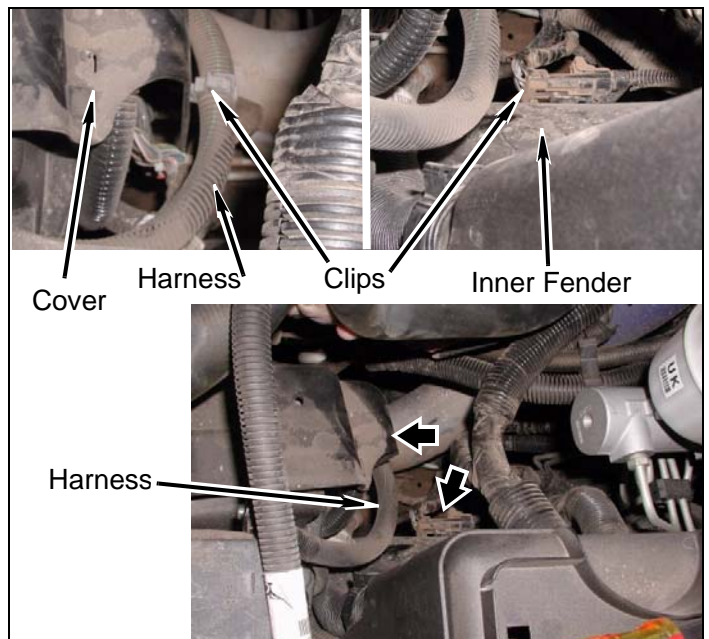

7. Wiring harnesses and power steering drivers side

a. Remove three bolts and ground wires from frame.

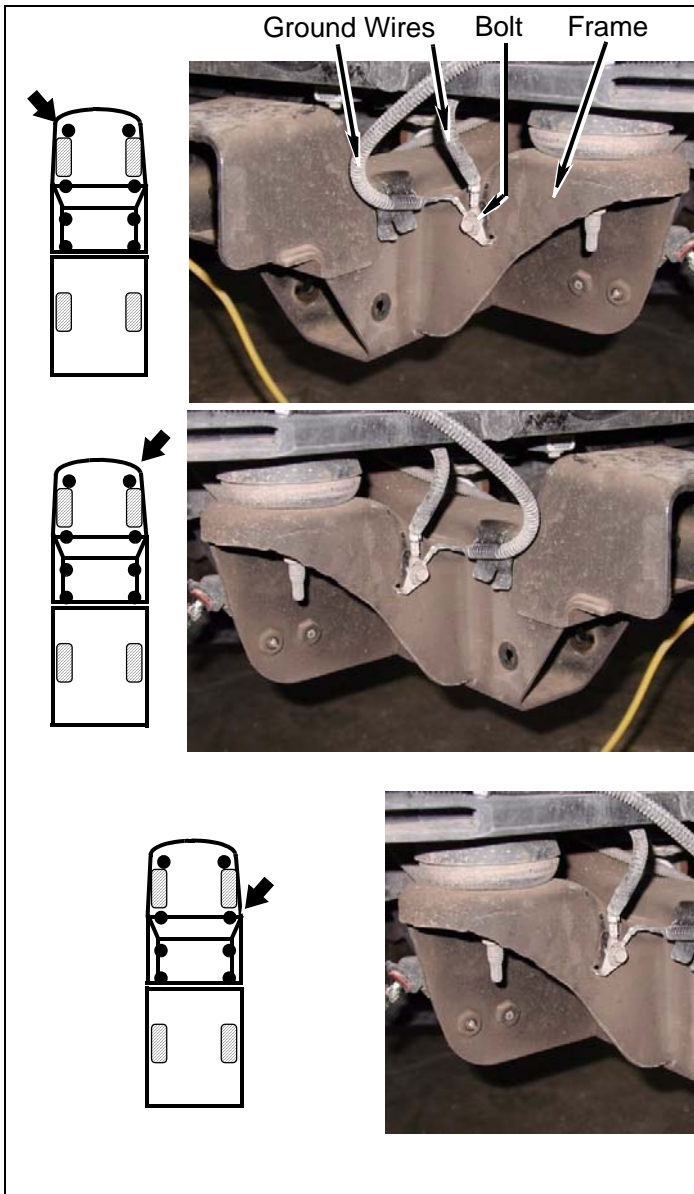

b. Remove clip and harness from frame and shock tower driver side.

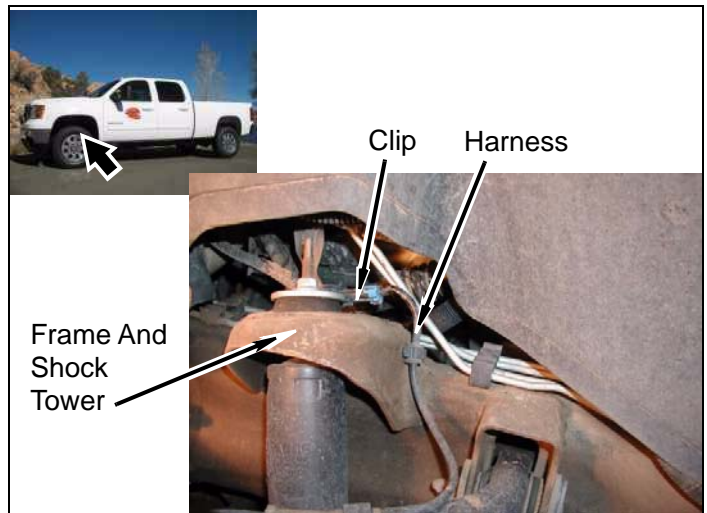

c. Carefully bend power steering pressure line at power steering pump by pulling toward fire wall as shown. Do not allow line to kink.

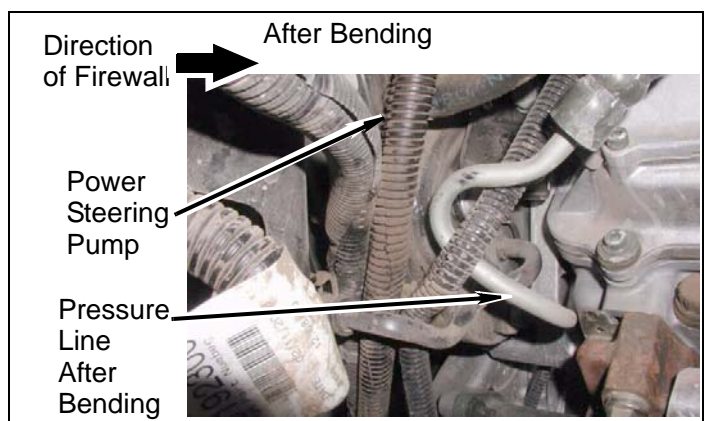
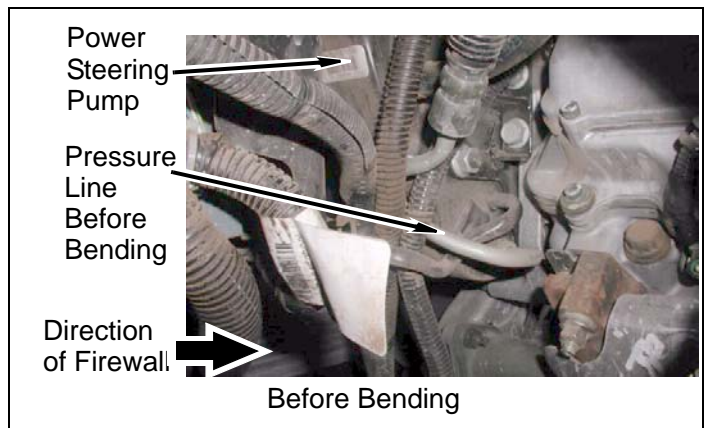

NOTE
Driver side inner fender well was removed for clarity and ease of access.

d. Carefully bend power assist pressure line up toward hood, to clear accumulator on brake hydro boost.

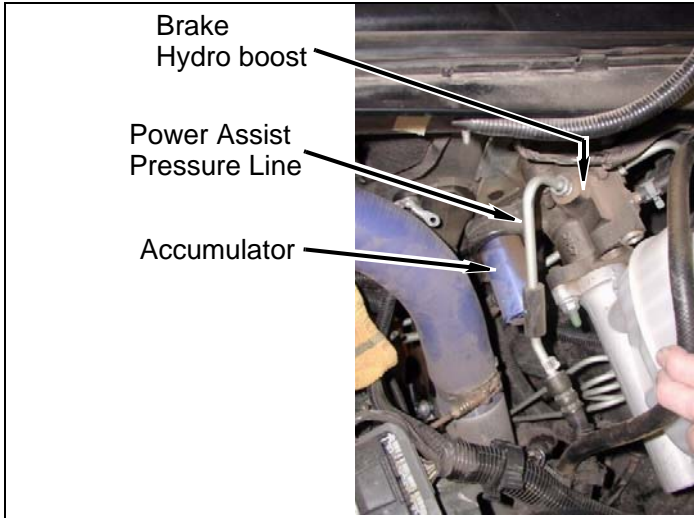

e. Loosen power assist pressure line fitting at brake hydro housing and position power assist pressure line along side of accumulator as shown.

f. Tighten power assist pressure line fitting at brake droopiest housing.

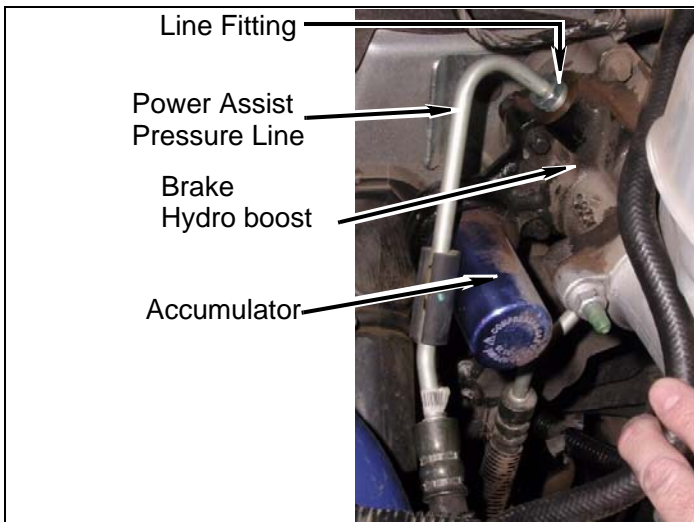

g. Remove bolt, clamp, and power assist pressure line from frame.

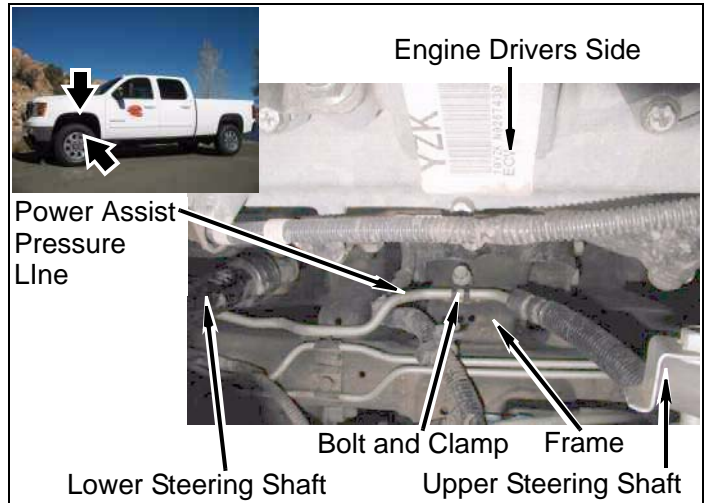

h. Remove two brake lines from two sets of clips driver side frame.

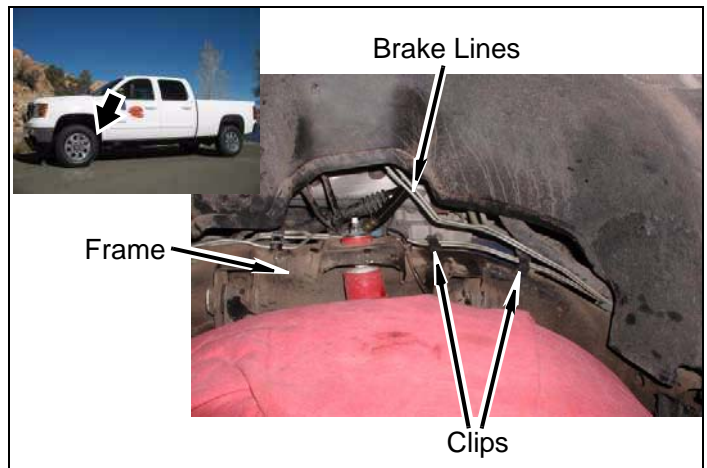

C. Frame

1. Parking brake cable

a. Remove bolt and ground wires from driver side frame mounting pad.

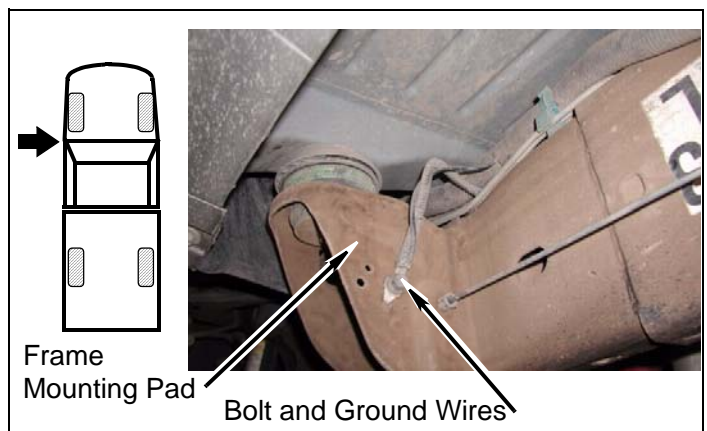

- b. Pull some slack in parking brake cable. Clamp two cables at cable housing where indicated by arrows.

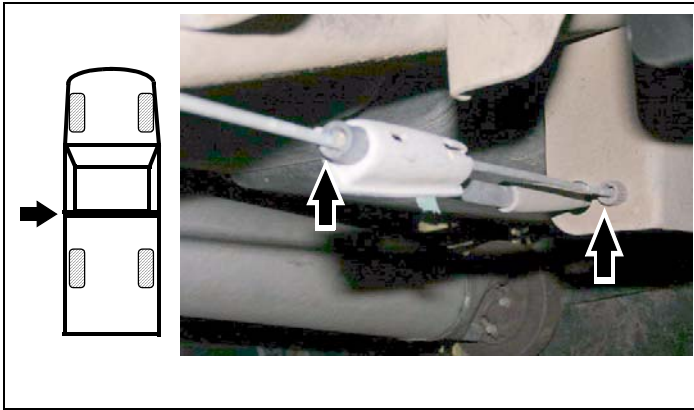

- c. Separate front parking brake cable from rear parking brake cable at cable connector.

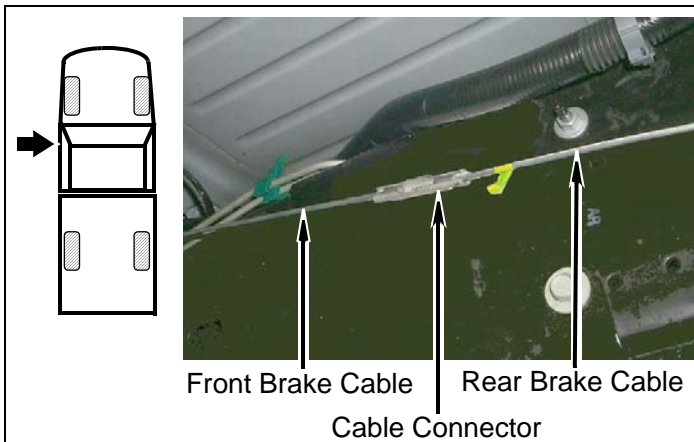

- d. Remove front brake cable and brake cable housing from front frame mounting pad.

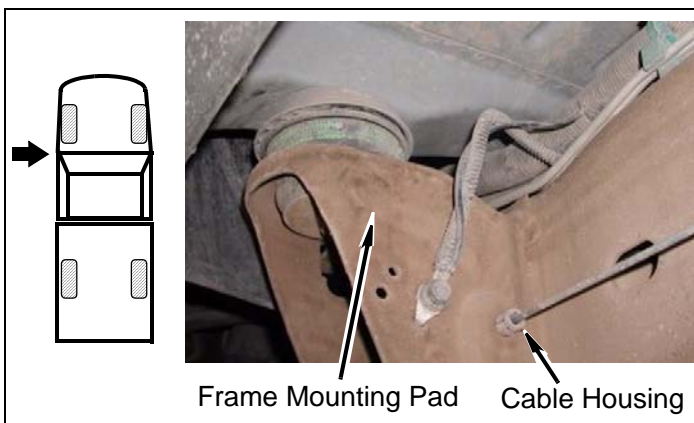

2. **Manual transfer case:** shift linkage

- a. Remove clip containing three metal lines from bracket.

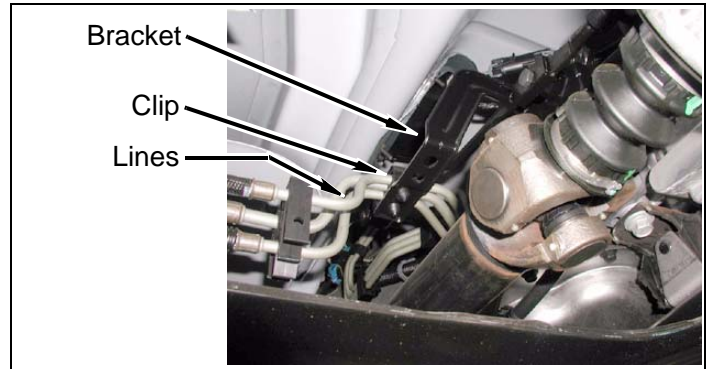

- b. Remove two nuts and bracket from transfer case. Bracket is not reused. Install two nuts and tighten.

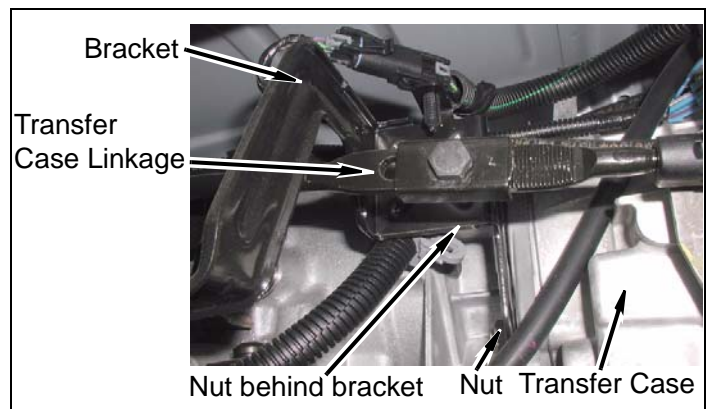

- c. Remove two clips and transfer case linkage from transfer case and pivot.

3. **Single cab only:** Safety cables

- a. If applicable, remove two bolts and safety cables from two rear frame mounting pads.

NOTE: Cabs will not be reinstalled.

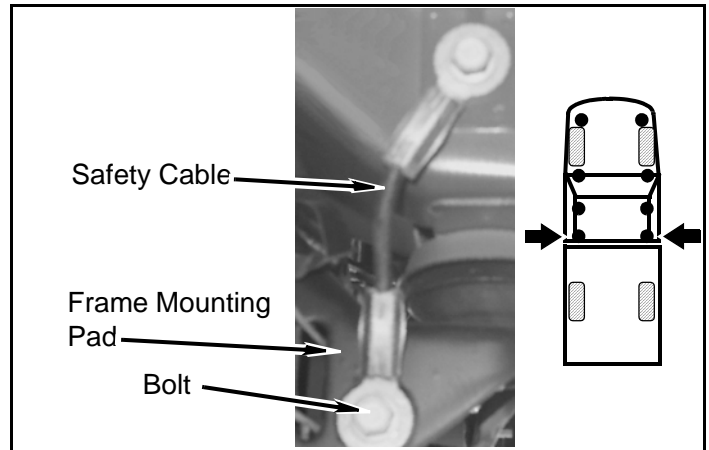

D. Rear of vehicle

⚠WARNING

Use extreme caution when working near fuel lines and fuel tank. Clean up spilled fuel immediately. Any spark could cause an explosion or fire resulting in serious personal injury and property damage.

1. Fuel filler

- Remove fuel cap, three bolts, and fuel filler from bed.

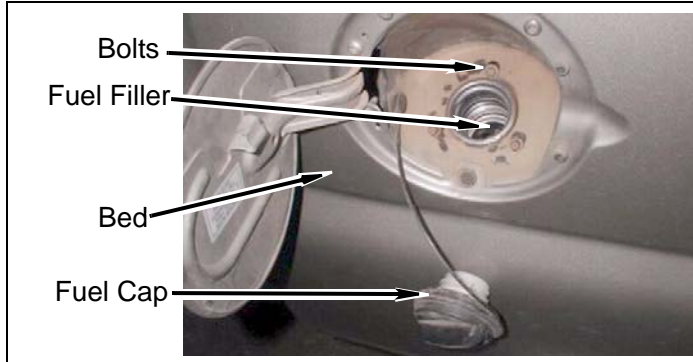

2. Rear bumper

⚠NOTE

Removal of spare tire might be helpful, but not mandatory (refer to the Owner's Manual).

- Unplug rear bumper light wiring harness from frame connector.

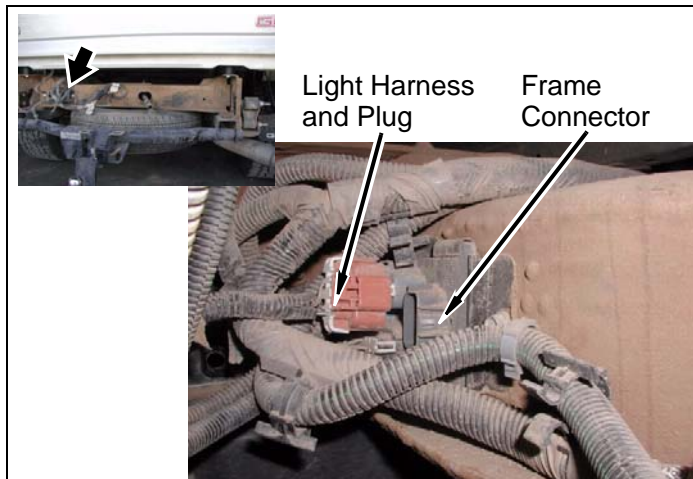

- Remove four nuts, two double-bolt fasteners, four bolts and bumper from frame rails.

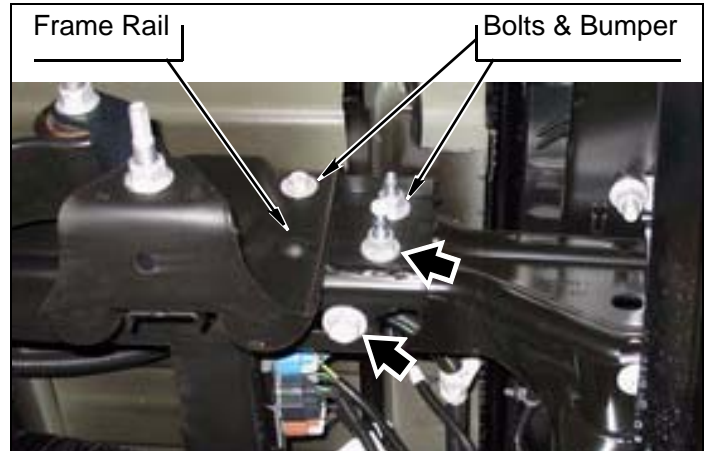

- Remove two bolts and bumper from hitch and vehicle.



⚠NOTE

Removal of rear bed bolts and lifting rear section of truck bed will be required to remove bumper from truck.

Install the kit

A. Cab

- Prepare to lift cab from frame

⚠WARNING

Failure to replace the OEM body mounting hardware (except mounting bolts in the kit) in the stock locations could result in serious personal injury or damage to the vehicle.

⚠NOTE

Ensure stock spacers and body bushings stay on vehicle unless otherwise specified in these instructions. Kit lift **blocks** are installed in addition to the stock spacers and body bushings.

- a. Loosen but do not remove, core support bolt and three cab bolts from drivers side cab.

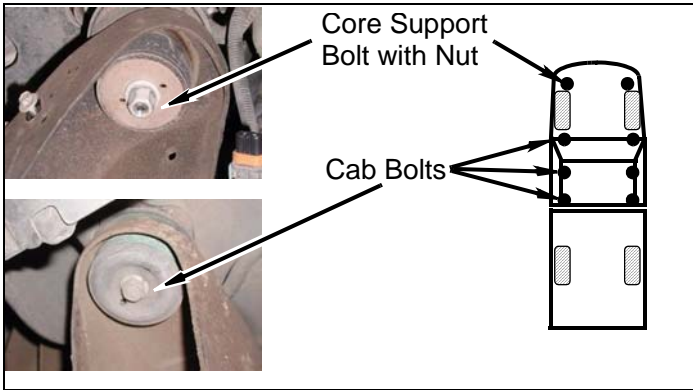

- b. Remove core support bolt, nut, and three cab bolts from passenger side cab.

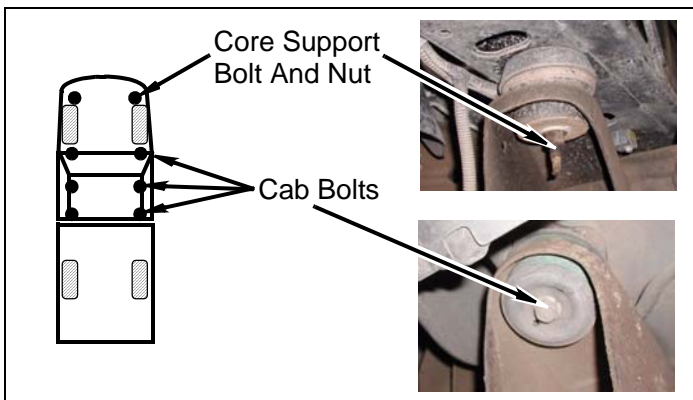

2. Passengers side

⚠CAUTION
Continually check hoses, wires, lines, etc. to be sure that everything is flexing properly and not binding, or damage to the vehicle could result. Be especially careful of the a/c hoses at the fire wall, the belt pulley, and at the core support. Ensure brake lines extend while lifting. Bending the lines to gain ample slack may be necessary. Be extremely careful not to kink the lines.

⚠WARNING
Use extreme caution when lifting body from frame. Ensure lifting device is securely placed. Keep hands out from between frame and body, or serious personal injury could result.

- a. Using a hydraulic jack and a wooden block, slowly lift cab high enough to position a kit lift **block** between core support and body bushing. Position three kit lift **blocks** between cab and remaining body bushings.

- b. Install a kit lift **block** under core support and on top of upper body bushing, frame, and lower body bushing with a kit **bolt** (12mm-1.75 x 200mm), kit **washer** (1/2" thick), and stock nut. Do not tighten.

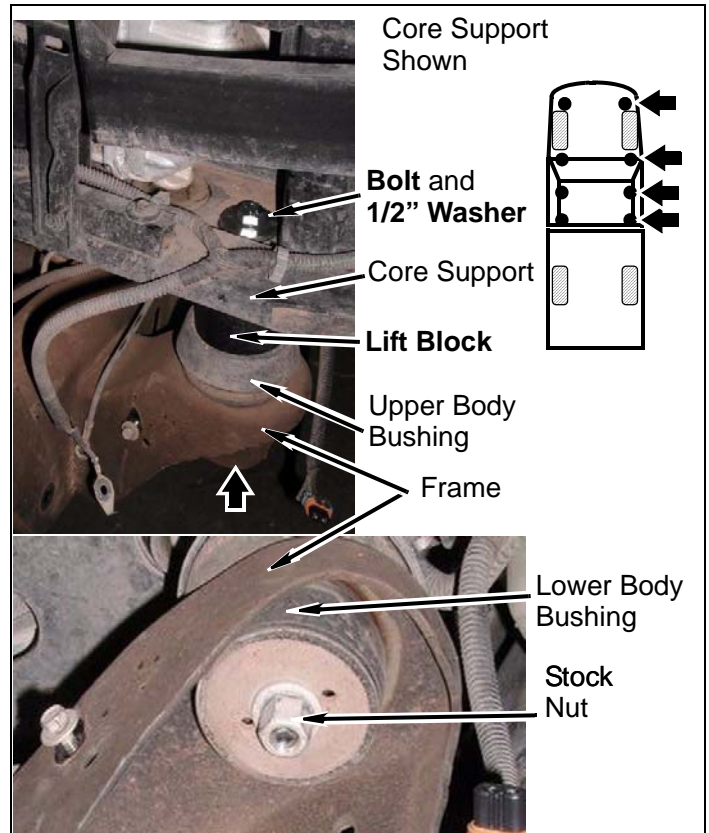

- c. Install three kit lift **blocks** (with 5/8" hole) under body and on top of top body bushings, frame, and lower bushings, with three kit **bolts** (14mm-2.0 x 180mm) and kit **washers** (14 mm). Do not tighten.

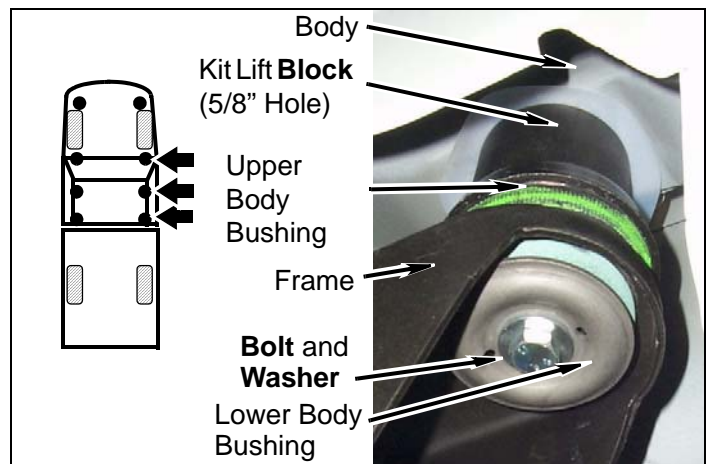

- d. Lower cab onto kit lift **blocks**.

3. Drivers side

- a. Repeat above steps for the cab driver side.
- b. Adjust cab to bed clearance as needed using measurements taken earlier.

- b. Position four kit lift **blocks** (3" Diameter) between bed and frame as shown.

4. Finish cab lift **block** installation

- a. Remove eight **bolts** one at a time, place a few drops of kit **Loctite®** on threads, install and tighten to 55ft.lbs.

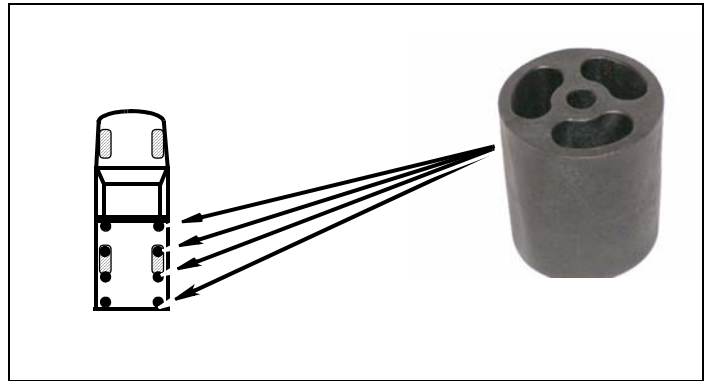

- c. Install kit lift **blocks** on frame and bed with four kit **bolts** (12mm-1.75 x 100mm) and four kit **washers** (7/16" USS). Do not tighten.

B. Bed

1. Prepare to lift bed from frame.

- a. Loosen but do not remove four bed bolts driver side (short bed three bolts).

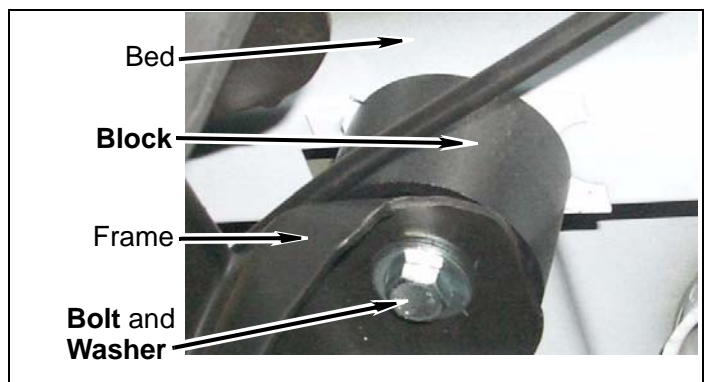
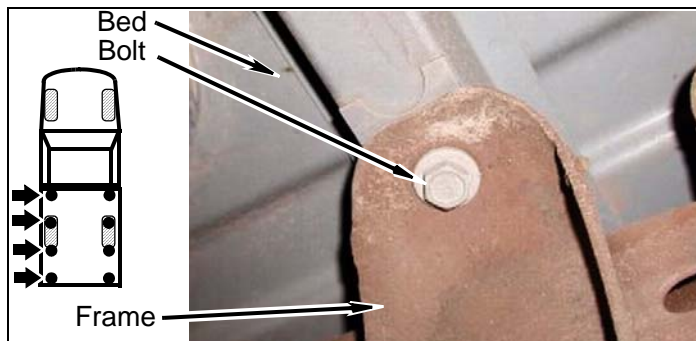

- b. Remove four bed bolts from frame passenger side.

- d. Lower bed onto kit lift **blocks**.

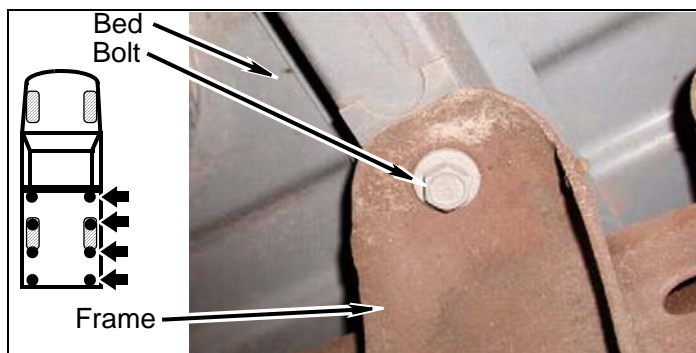

3. Install driver side bed kit lift **blocks**.

- a. Repeat above steps for driver side.

4. Finish the bed kit lift **block** installation.

NOTE
Place a few drops of Loctite® on threads of all bolts.

- a. Adjust bed to cab clearance as needed using measurements taken earlier.

- b. Remove eight kit **bolts** one at a time, place a few drops of kit Loctite® on threads, install and Tighten to 55ft.lbs.

2. Bed passenger side

- a. Using a hydraulic jack and a wooden block, slowly lift the bed high enough to position the kit lift **blocks** between bed and frame mounting pads.

C. Rear of vehicle

⚠WARNING

The following procedure is intended only to enhance the appearance of the vehicle. The rear bumper will no longer be rated for towing of any kind. Towing with the rear bumper after it has been lifted can result in death, serious personal injury, or damage to the vehicle. Towing after the bumper has been lifted should be accomplished using a rated Class III receiver type hitch.

1. Install rear bumper
 - a. Mark, cut, and bend crossmember for spare tire crank tube as shown.

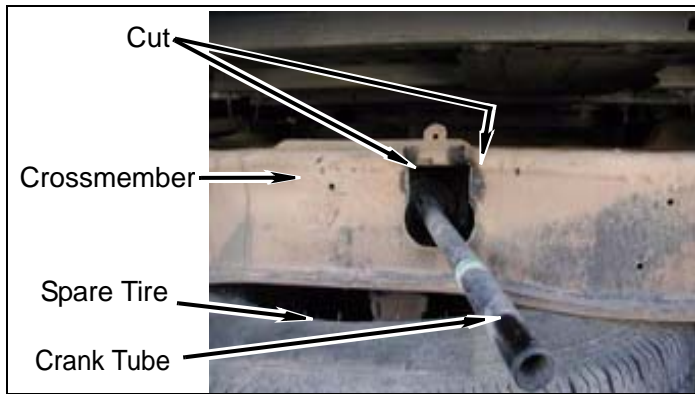

2. Rear bumper
 - a. Remove rear licence plate and rear tire winch tube door from main rear bumper shell.



- b. Remove three clips and two screws from each inside fascia and rear bumper.

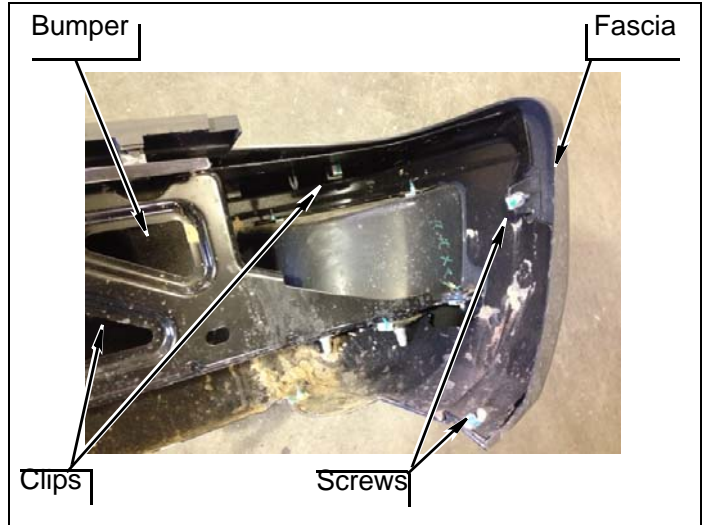

- c. Remove plastic fascia from corner of bumper by gently using a pry bar to loosen each clip.

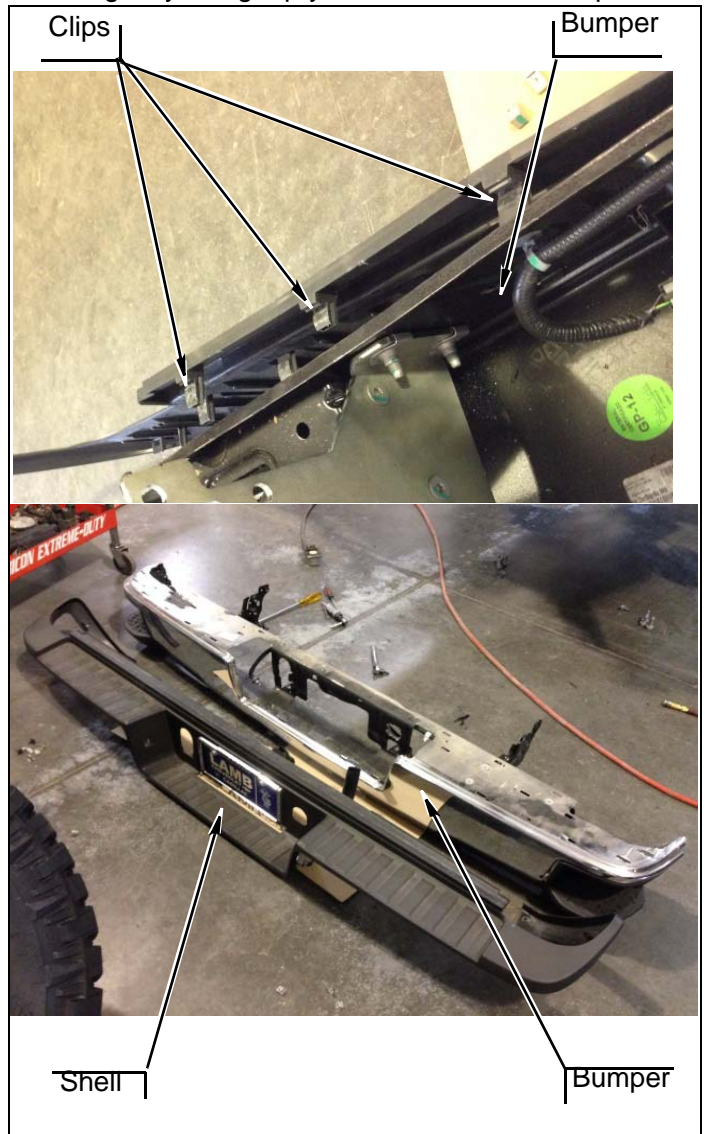

d. Remove five torx bolts from each bumper bracket and remove bumper bracket from shell.

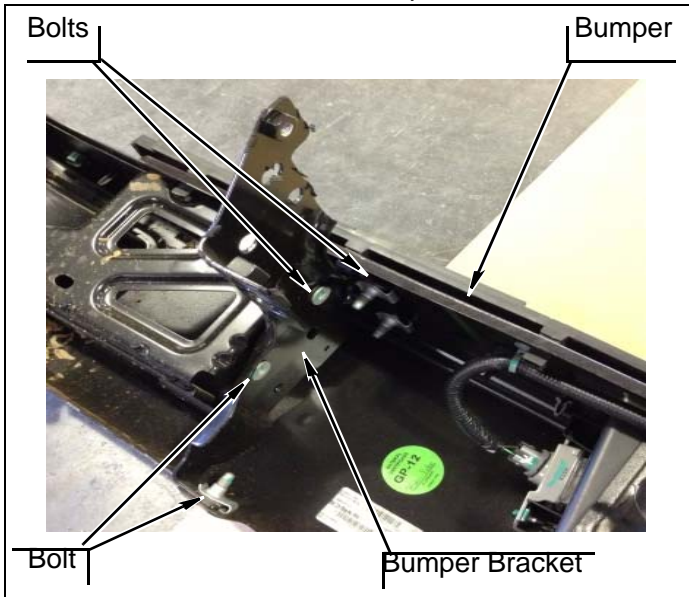

e. Remove u-nuts from OE Bumper bracket and reinstall u-nuts onto *kit bumper brackets*.

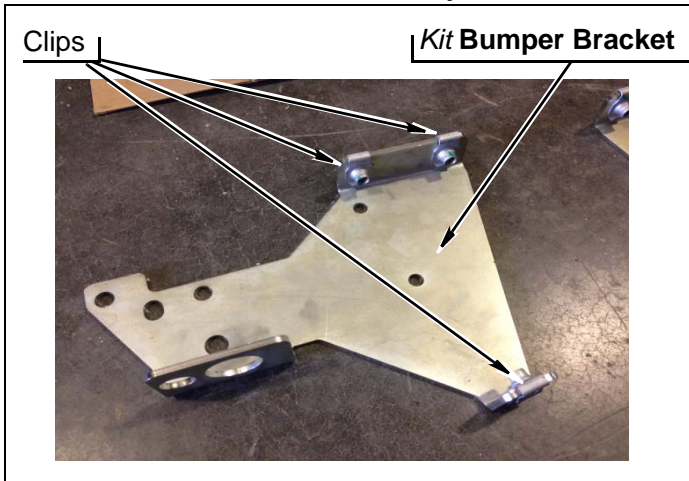

f. Position two *kit brackets* (bumper, rear) onto bumper and reinstall OE bolts.

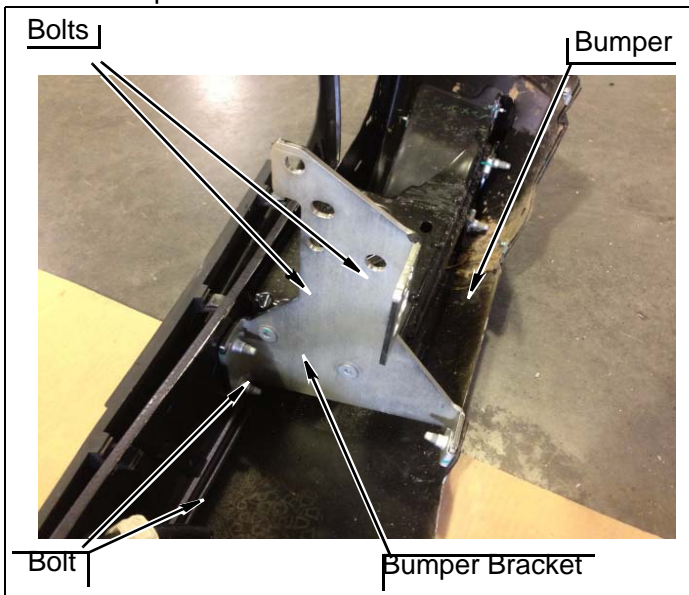

g. Use two *kit thick washers* in-between *kit bumper bracket* and bumper coner support bracket before installing both OE center bolts.

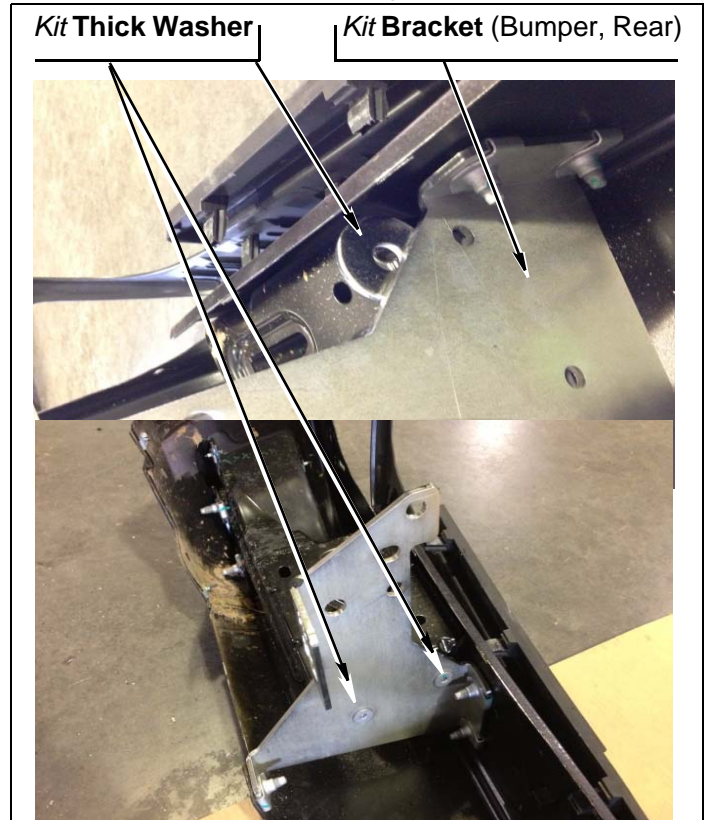

h. ****Prior to tightening bumper brackets, ensure that *kit bumper brackets* will fit inbetween frame rails, then tighten all *kit bumper bracket* bolts at this time; be sure both bumper brackets are square to frame rails.**

i. Reinstall plastic fascia onto bumper shell by gently pushing each molded clip into bumper shell along with six clips and four corner screws.

- j. **OEM Tow Hitch Models:** Mark & Cut both rear hitch tabs as shown to clear new bumper location.

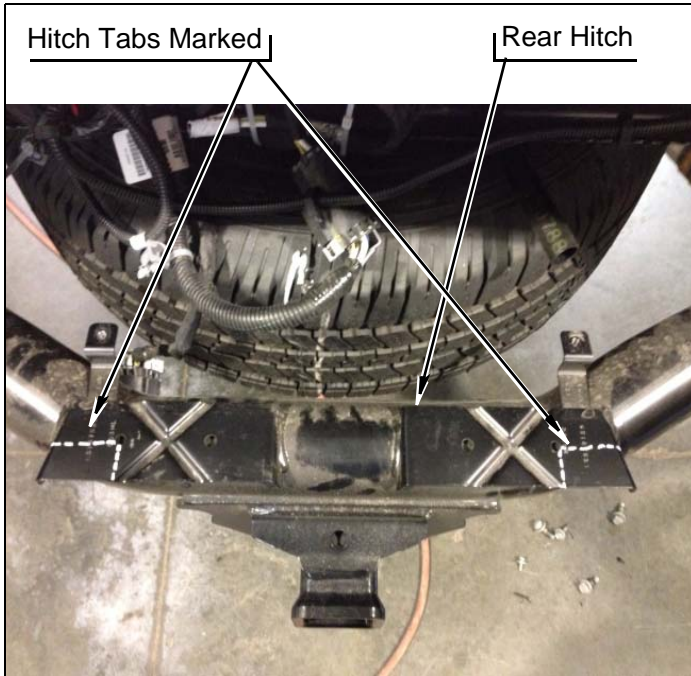

- k. OEM Hitch Tabs Removed.

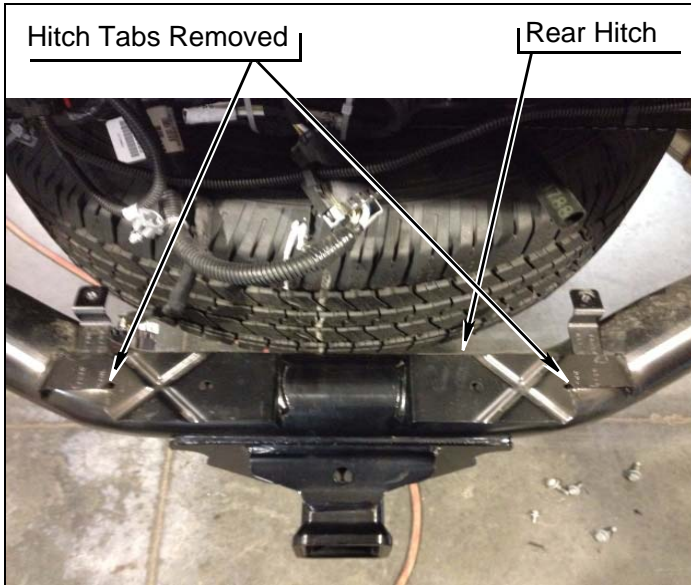

- l. Install bottom of bumper onto bumper support with two bolts.
- m. Install fascia onto bumper with two clips.

- n. Install bumper onto frame rails with all O.E. double-bolt fasteners and nuts. **DO NOT TIGHTEN...**

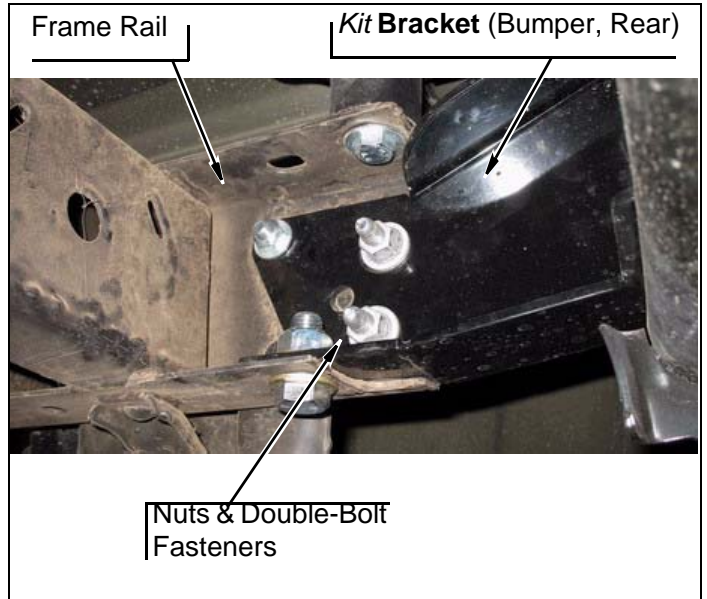

- o. Adjust bumper to bed clearance using measurements taken earlier and tighten hitch bolts first then remaining bolts and nuts to 55 lb-ft.
- p. Plug license plate light harness in at crossmember connector.

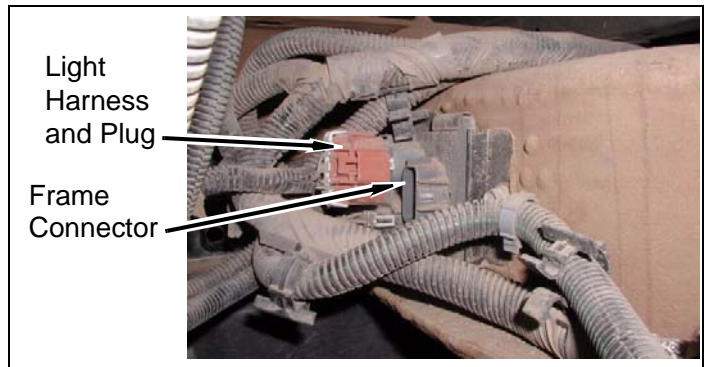

3. Fuel filler

⚠WARNING

Use extreme caution when working near fuel lines and fuel tank. Clean up spilled fuel immediately. Any spark could cause an explosion or fire resulting in serious personal injury and property damage.

- a. Install fuel filler on the bed with three bolts. Install fuel cap.

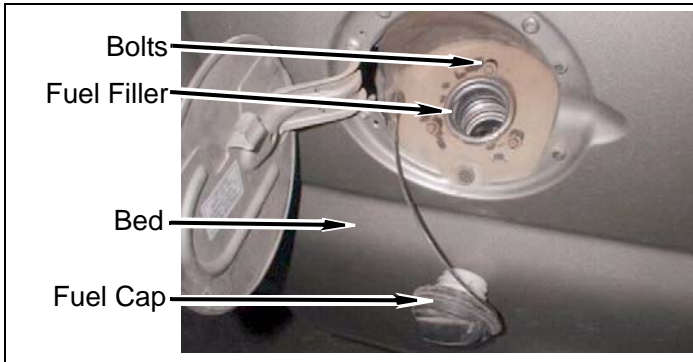

- b. Relocate parking brake cable into *kit park bracket* and mount using *kit 7/16"* hardware. .

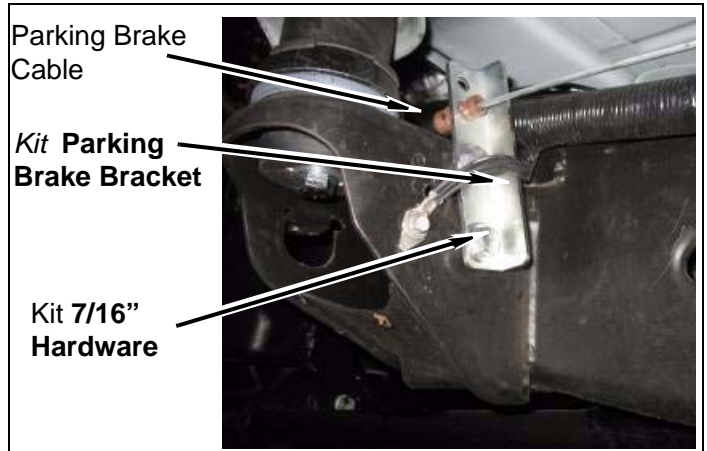

D. Frame

1. Parking brake cable.

NOTE
Some filing of drilled 7/16" hole may be required to allow parking brake cable housing to fit properly.

- a. Using kit parking brake bracket as templet, mark & drill a 7/16" hole in the frame over original hole as shown.

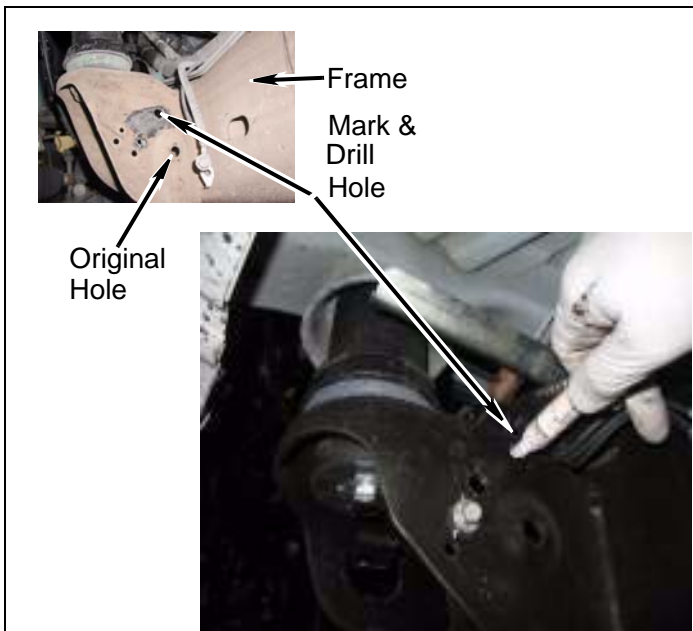

- c. Install two ground wires onto *kit parking brake bracket* with *kit bolt* (1/4") nut and washers. Connect front and rear brake cables. Remove clamps from rear cable.

Note: *Kit washer* (thick) may be used between *kit bracket* and body mount to keep bracket aligned.

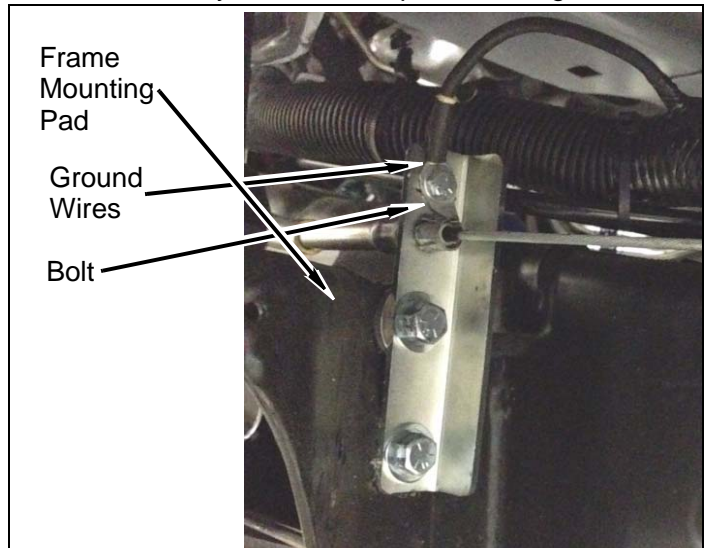

- d. Remove dvr side wiring harness from frame rail and secure it to fuel and brake lines using *kit zip ties*.

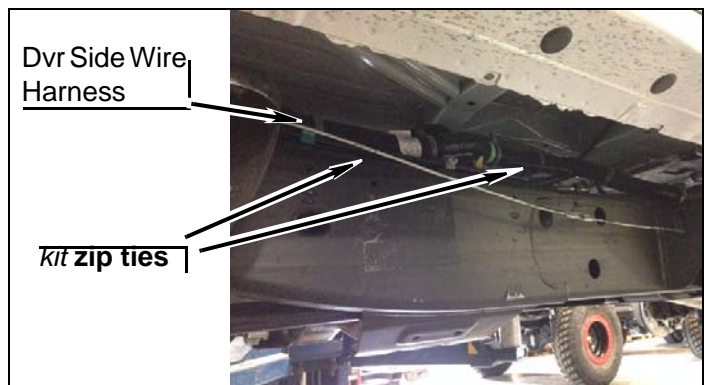

NOTE

The following step is for vehicles with manual transfer case only. Other models skip this step.

2. Lengthen and install transfer case shift lever.

- a. Remove two spring clips and transfer case linkage from shift lever, transfer case shift arm.

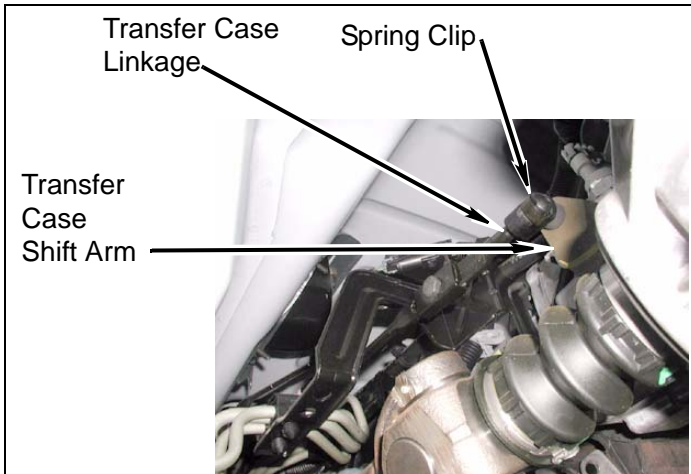

- b. Scribe a line along transfer case linkage as shown. Cut transfer case linkage into two pieces through the scribed line and deburr.

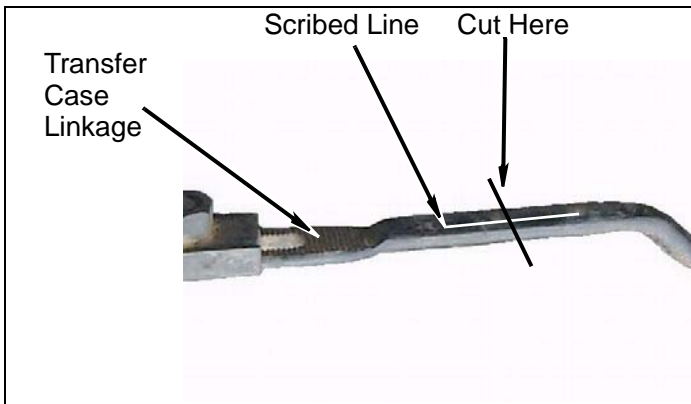

WARNING

A certified welder should perform all welding.

- c. Position kit pin 4x4 extension between two pieces of transfer case linkage. Ensure transfer case linkage scribed lines align and weld kit pin extension in place.

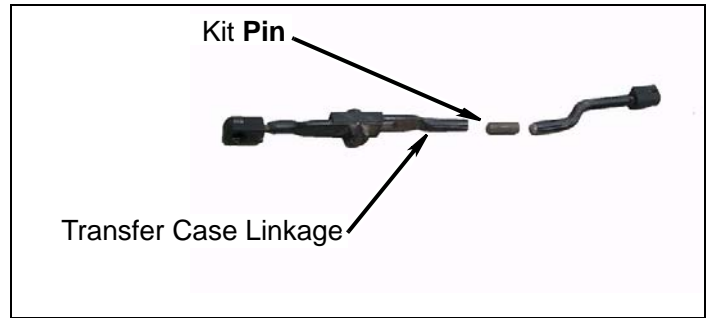

- d. Install transfer case linkage on transfer case shift arm and shift lever with two clips.
- e. Check transfer case shift lever operation. Ensure there is complete engagement in all ranges. If necessary, adjust the linkage.

3. Driver side wheel well and frame rail.

- a. If possible, install four harness clips on frame and wheel well.

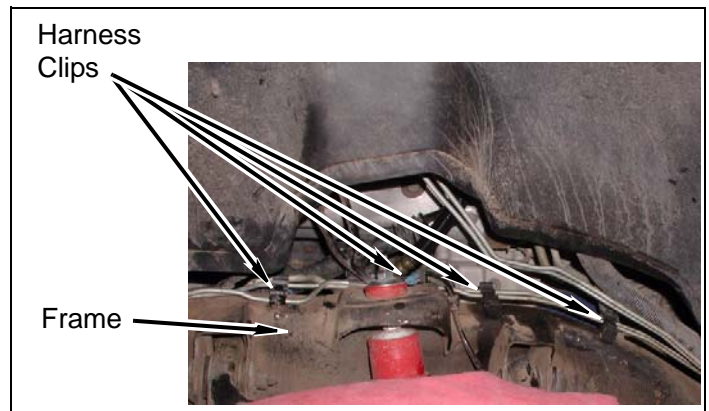

- b. If possible, install two brake lines in two sets of clips. If brake lines will not fit back into position, wrap lines with two kit **zip ties** individually, and then secure the lines together with one kit **zip tie** as a bundle.

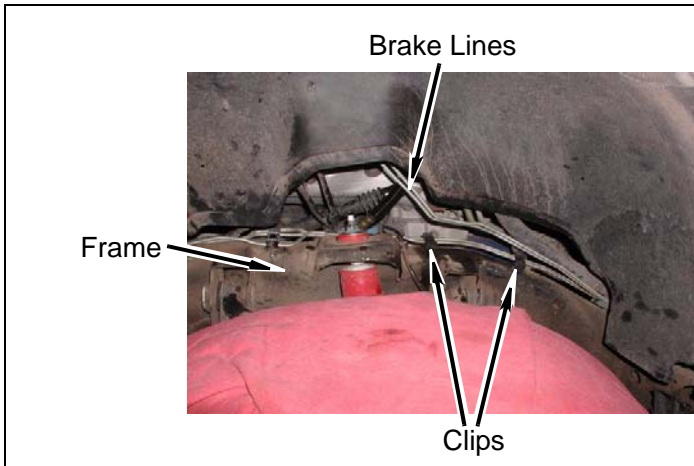

- c. If possible, install harness in clip on frame driver side.

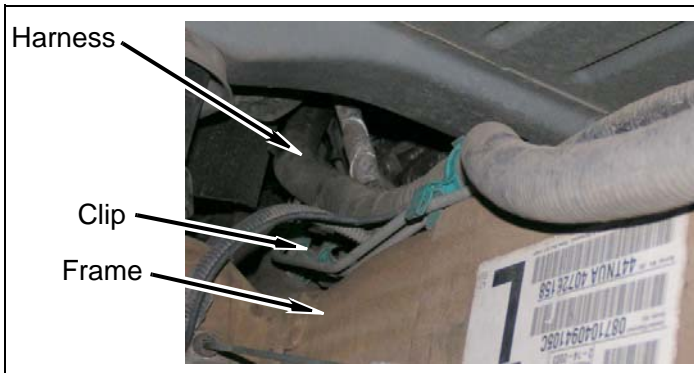

4. Install ground strap extension brackets

- a. Install three **kit ground strap ext. brackets** and ground wires onto frame using OEM hardware and **kit nuts** (1/4") and **washers** as shown:

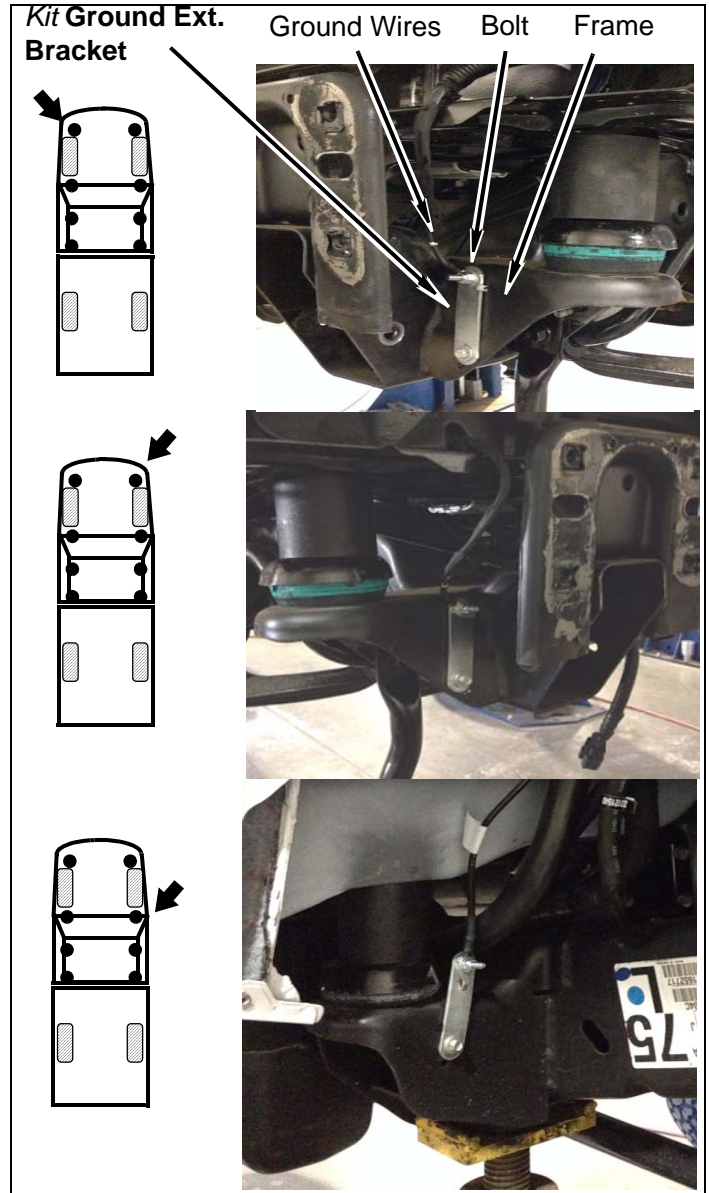

E. Engine Compartment

1. DEF filler neck extensions install

- a. Using two **kit brackets** (2" drop), **nuts** (1/4") and OEM nuts attach DEF filler neck to firewall.

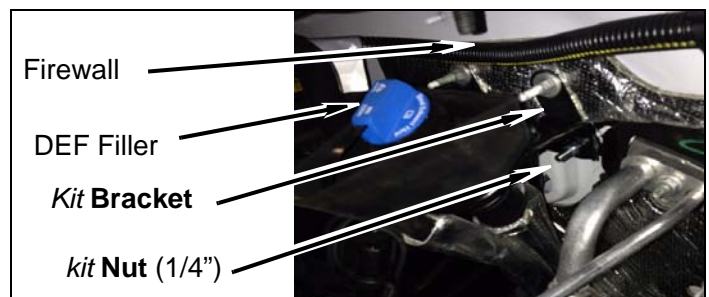

2. Intercooler piping passenger side

- a. Remove factory flex hose from Upper and Lower Piping. ****VERY CAREFULLY**** cut nylon clamps from Upper and Lower piping. ****Be sure NOT to cut factory flex hose during this process****

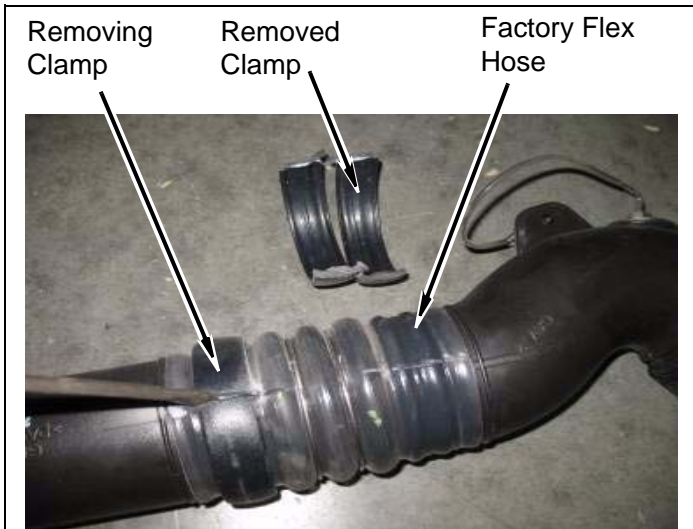

- b. ***Measure and Cut*** Upper and Lower intercooler pipes. ***Measure and Mark*** $\frac{3}{4}$ " from **EACH** end of the Upper and Lower intercooler pipes. ****Carefully cut intercooler pipes without damaging "inner metal support ring". Be sure to clean ALL metal & plastic particles from pipes before reinstalling piping into engine bay.**

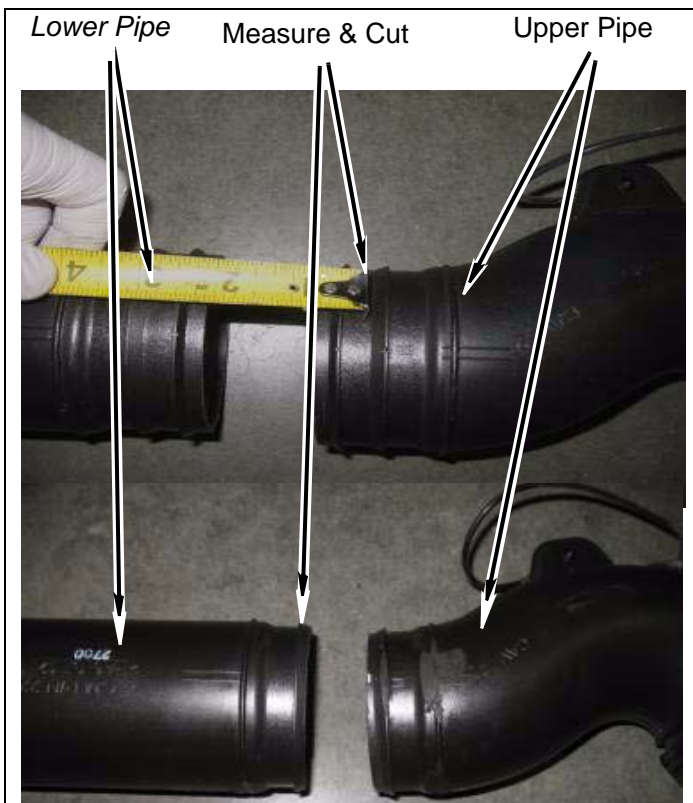

- c. ***Measure and Cut* O.E. Flex Hose.** ***Measure and Mark*** $\frac{1}{4}$ " from **EACH** end of the Flex Hose. ***Carefully cut Flex Hose. Be sure to clean ALL particles from Flex Hose.**

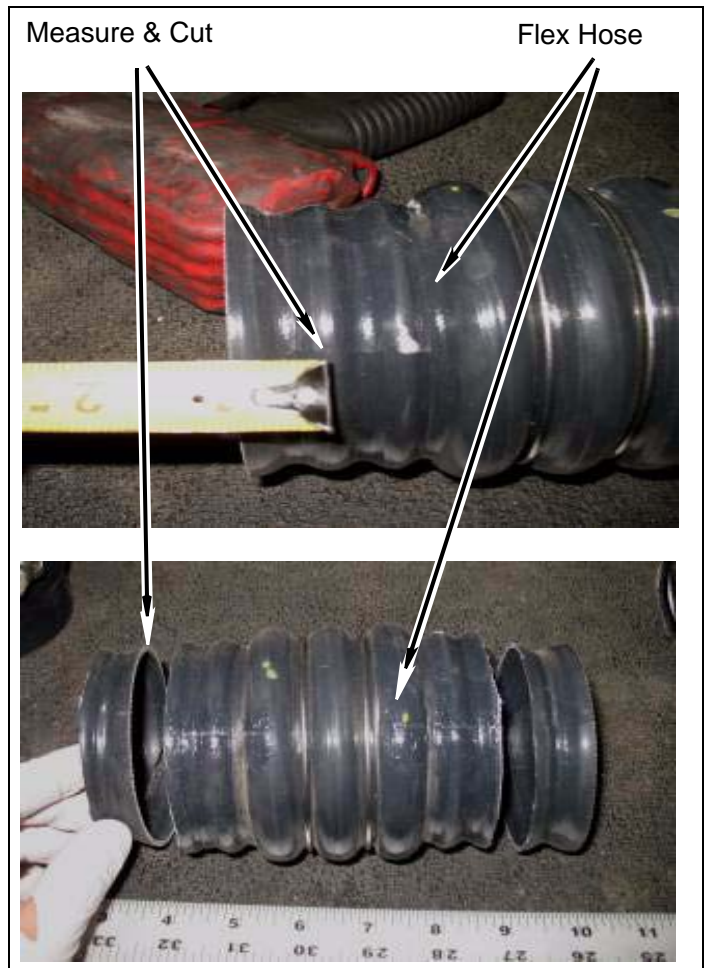

- d. Place O.E. Flex Hose onto Upper / Lower intercooler pipe. Install two **kit hose clamps** onto intercooler pipe and Flex Hose, **do not** tighten **kit hose clamps** at this time.

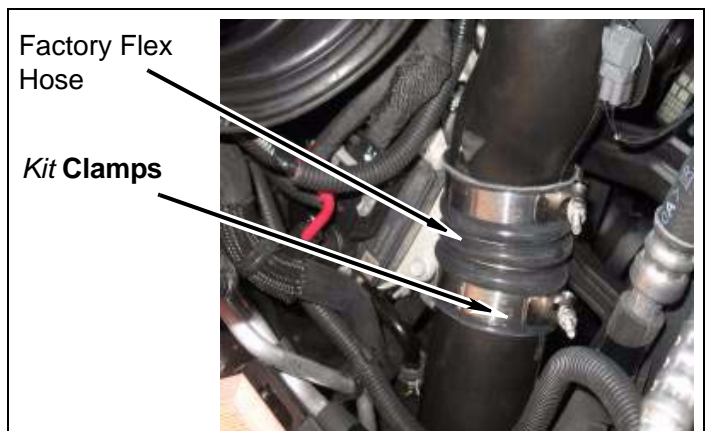

- e. Install factory upper and lower intercooler pipes onto throttle body and intercooler. Adjust and Tighten two *kit hose clamps* on O.E. Flex Hose.

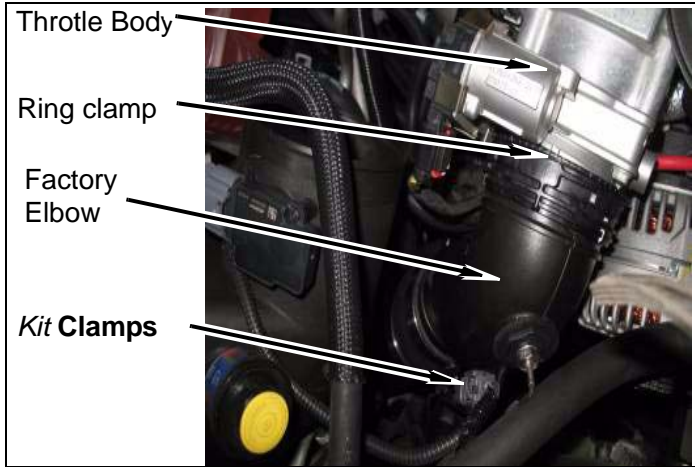

3. Intercooler piping engine side

- a. Twist and position silicone elbow onto engine side so to eliminate any binding in hoses and tighten clamp, silicone hose, and intercooler hose from engine side.

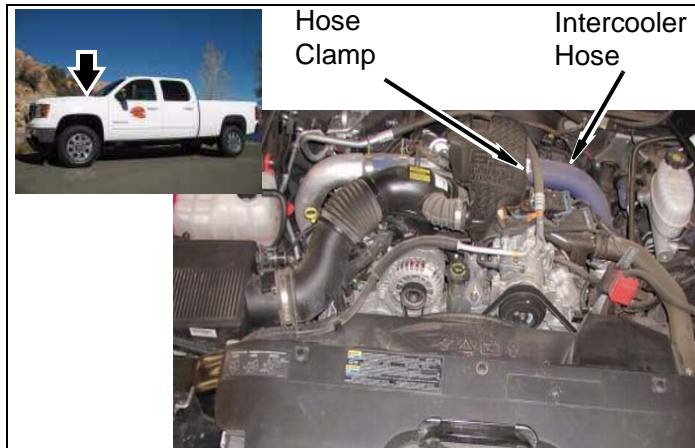

4. Wiring harnesses and ground strap

- a. If possible, install clip in bracket (*top of engine*).

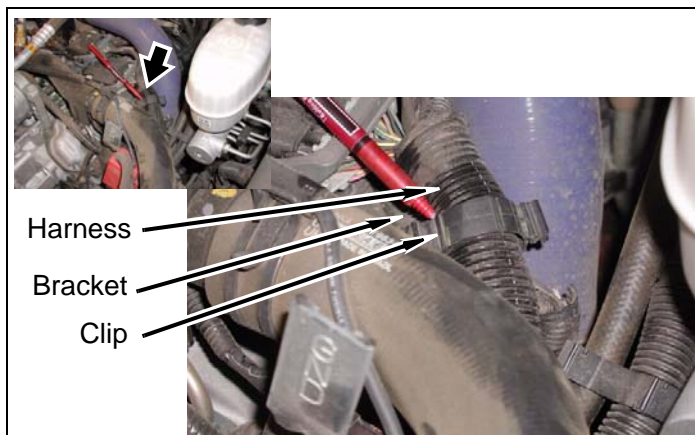

- b. Install ground strap on stud with nut.

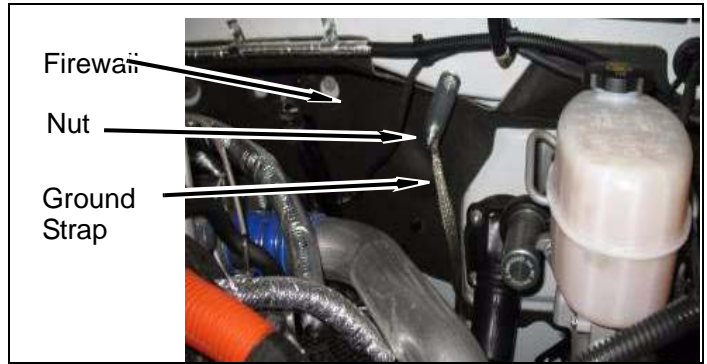

5. Install kit steering extension.

- a. Remove small tab sleeve spacer from inside of steering shaft and cut small tab off of steering sleeve space and place back inside of upper steering shaft. This step will ensure proper installation of *kit steering extension*.

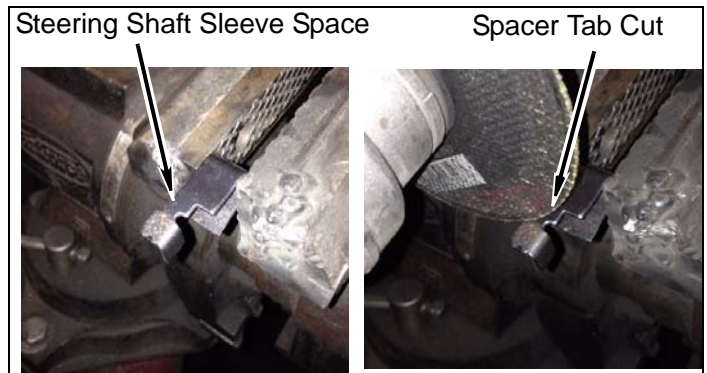

- b. Place a few drops of kit Loctite® on threads of bolts for both following steps.
- c. Install kit **steering extension** on upper steering shaft with kit **bolt** (3/8" x 1 3/4"), two kit **washers** (3/8" SAE), and kit **nut** (3/8" nylock). Do not tighten.
- d. Install kit **steering extension** into lower steering shaft with bolt and nut. Tighten bolt to 33 lb-ft.

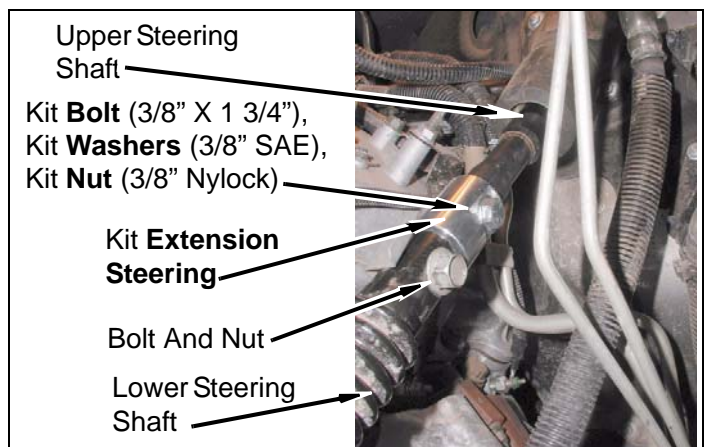

6. Upper fan shroud.

- a. Remove small tab on upper left corner of fan shroud

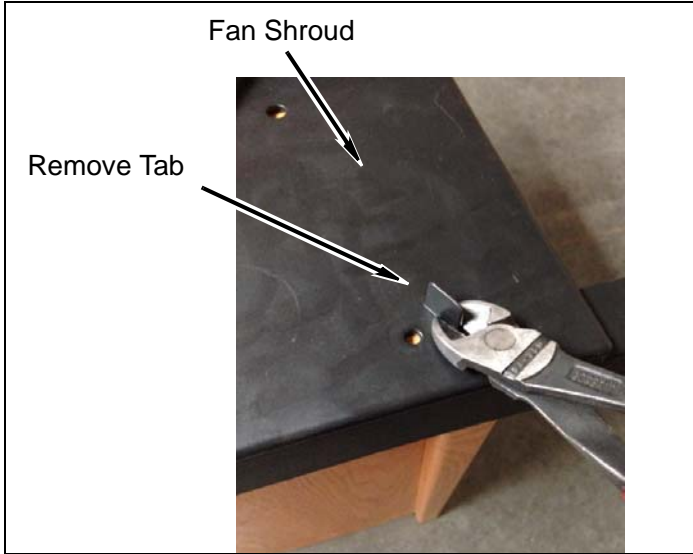

- b. Measure upper fan shroud from top down to lower edge of side mounting tab as shown (about 1"). Mark and cut upper fan shroud as shown.

NOTE: Must follow contour of fan shroud diameter, shroud must remain intact for proper installation.

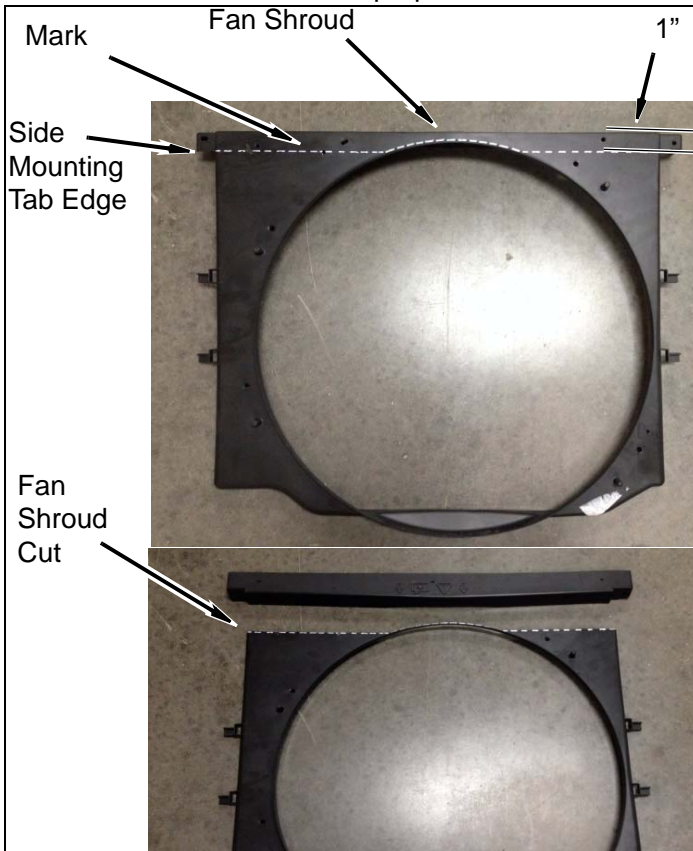

- c. Assemble three kit **brackets**, **upper fan shroud** (left, center, and right) with two kit **bolts** (1/4" x 3/4"), four kit **washers** (1/4" SAE), and two kit **nuts** (1/4" nylock) as shown. Snug, bolts but do not tighten.

Note: Make sure all kit nylock nuts are facing out.

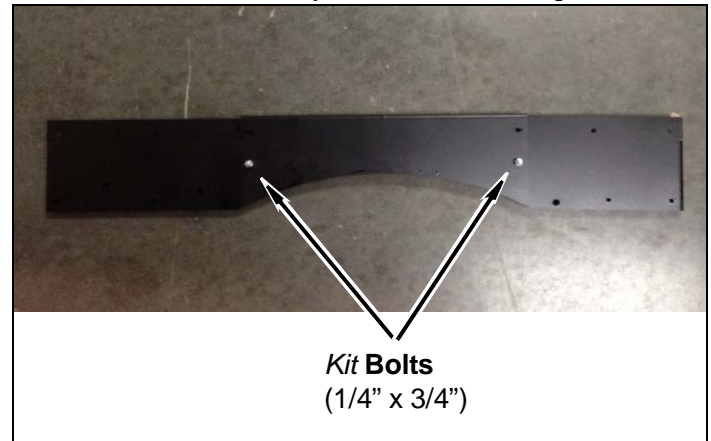

- d. Secure lower fan shroud sections on flat surface.
- e. Measure kit **bracket**, **upper fan shroud** (center) from table top as shown. Ensure bracket is level.

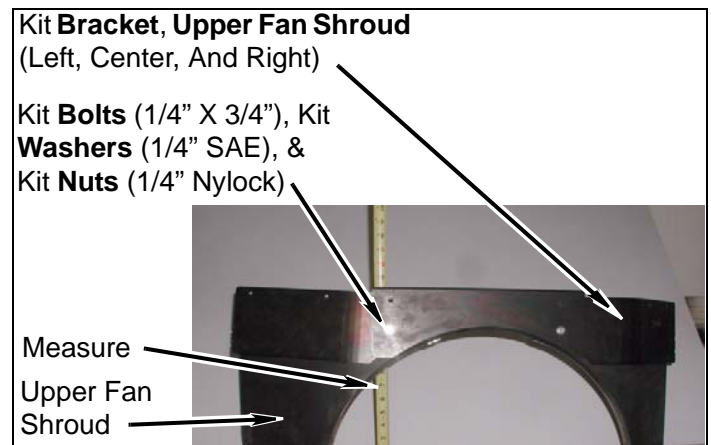

- f. Clamp two scrap pieces of metal (or rulers) to fan shroud as shown. Position upper fan shroud on metal scrap and under kit **bracket**, **upper fan shroud** (center).

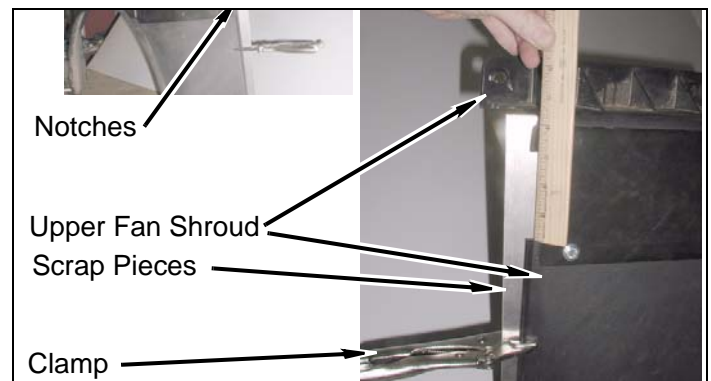

- g. Using three kit **brackets**, **upper fan shroud** (left, center, and right) as templates, drill 1/4" holes in fan shroud.
- h. Install three kit **brackets**, **upper fan shroud** (left, center, and right) on upper fan shroud with fourteen kit **bolts** (1/4" x 3/4"), kit **washers** (1/4" SAE), and kit **nuts** (1/4" Nylock).

Note: Make sure all kit nylock nuts are facing out.

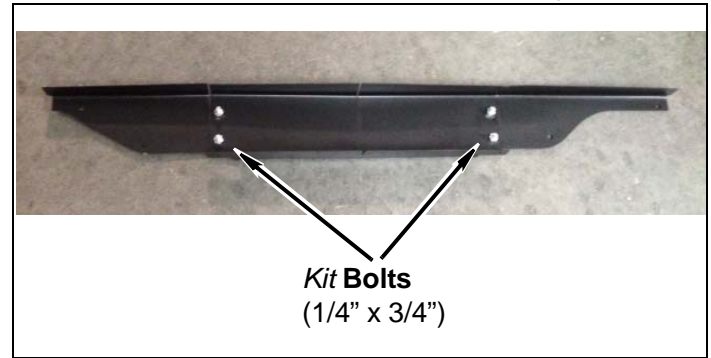

- b. Secure lower fan shroud sections on flat surface.
- c. Using three kit **brackets**, **lower fan shroud** (left, center, and right) as templates, drill 1/4" holes in fan shroud.
- d. Install three kit **brackets**, **lower fan shroud** (left, center, and right) on upper fan shroud with six kit **bolts** (1/4" x 3/4"), kit **washers** (1/4" SAE), and kit **nuts** (1/4" Nylock).

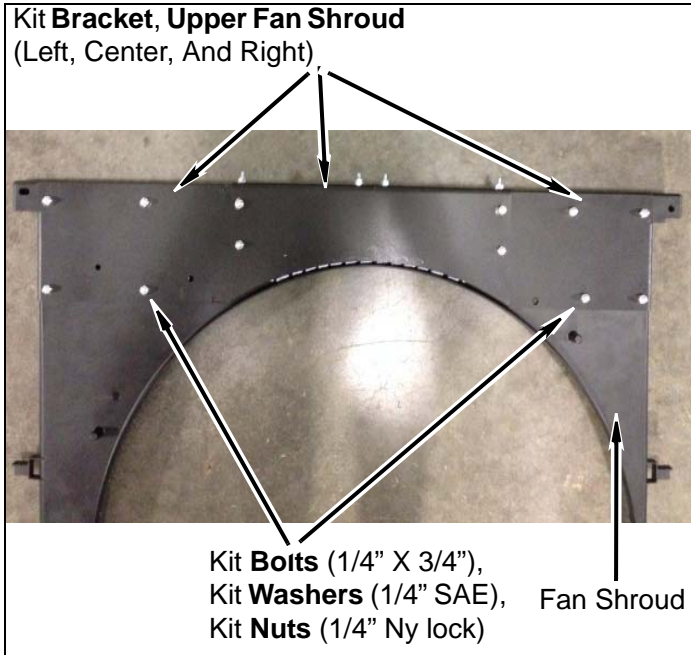

- i. Using a cut-off wheel; cut kit **bolt** (1/4" x 3/4") flush with kit **nut** (1/4" Nylock) as shown below:

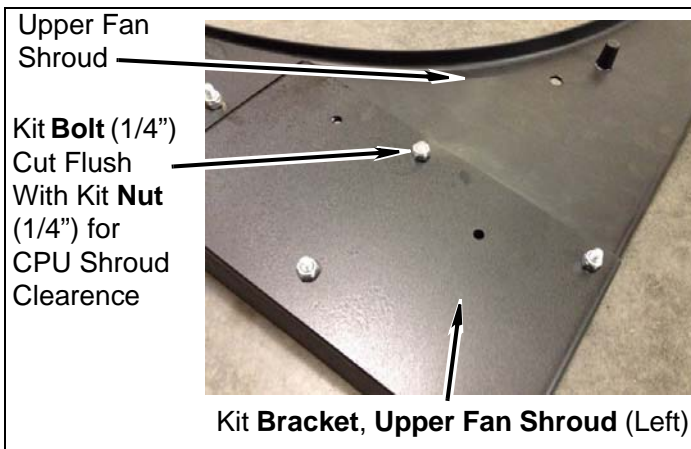
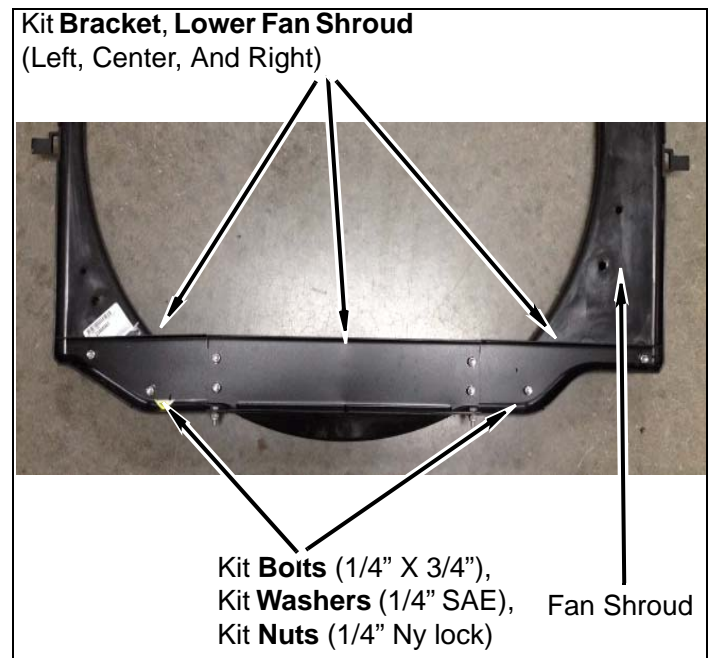

- 8. Install fan shroud relocation tabs

7. Lower fan shroud section

- a. Assemble three kit **brackets**, **lower fan shroud** (left, center, and right) with four kit **bolts** (1/4" x 3/4"), four kit **washers** (1/4" SAE), and four kit **nuts** (1/4" nylock) as shown. Snug, bolts but do not tighten.

- a. Place **kit fan shroud tab** (Z-bent) 3 inches above stock locations for both dvr side tabs and only the top psg side tab. Using bracket as template, drill two 1/4" holes for each bracket and secure them to the fan shroud using two kit **bolts** (1/4" x 3/4"), kit **washers** (1/4" SAE), and kit **nuts** (1/4" nylock) as shown:



- b. Remove four stock tabs as shown below:

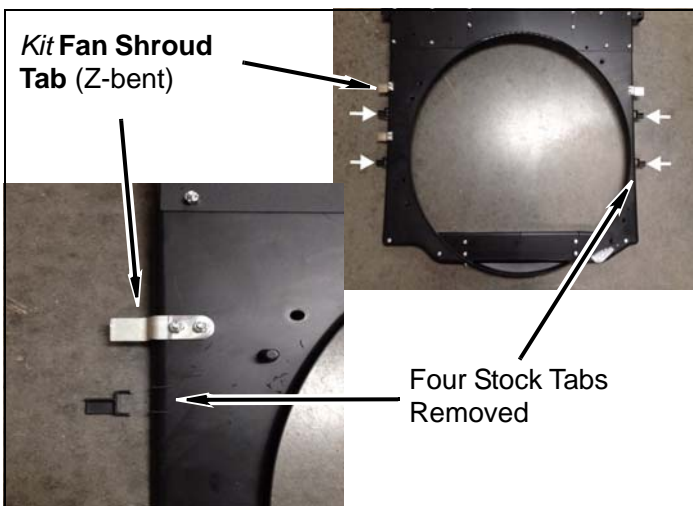

- c. Place secondary fan shroud onto primary fan shroud with newly installed **kit fan shroud brackets** and **kit fan shroud tab** (Z-bent), check for any clearencing issues that may need to be addressed for proper air sealing.
- d. Psg side **kit fan shroud tab** (Z-bent) will have a minor interference fit and will need to be trimmed as shown below:

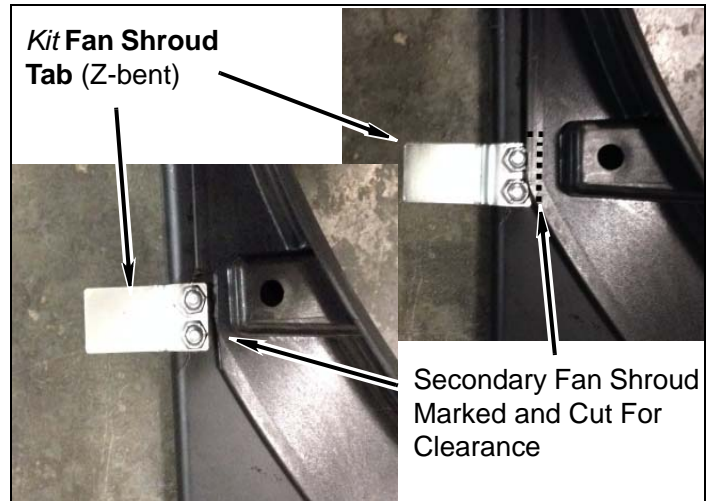

- 9. Install fan shroud into vehicle

- a. Install fan shroud assembly on core support with two OEM push pins. Do not tighten.

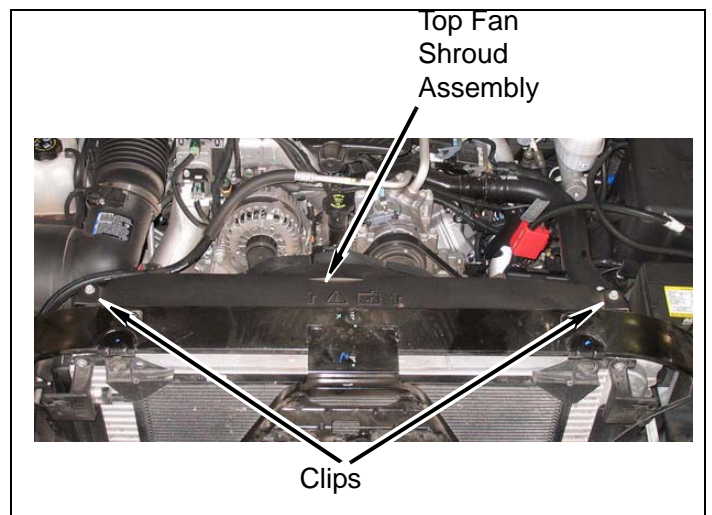

b. Reinstall fan/clutch, fan cage and secondary fan shroud as one assembly carefully back into vehicle.

e. Reinstall four bolts into fan cage around front of engine.

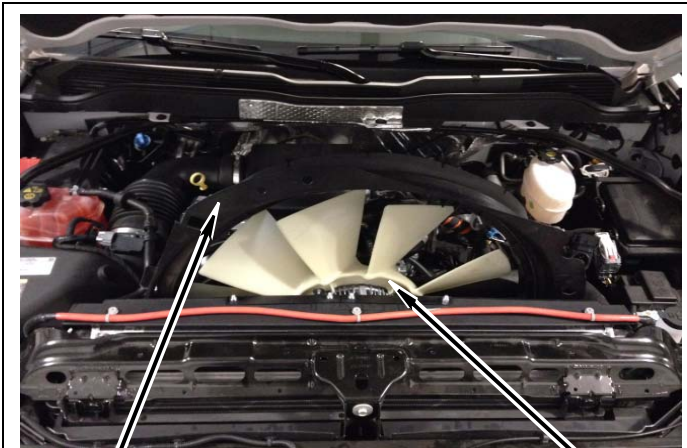

Secondary Fan Shroud

Fan Clutch

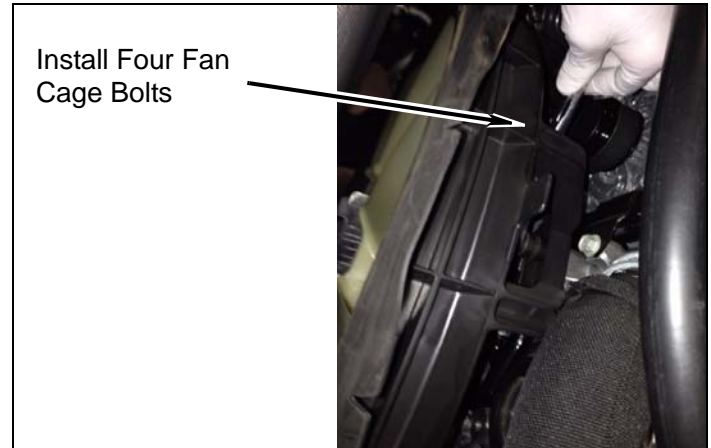

Install Four Fan Cage Bolts

f. Install four fan shroud push clips(12) from secondary(11) into main(10) shroud.

NOTE: Be sure that the air gasket is reinstalled against main fan shroud properly to reduce air pressure loss.

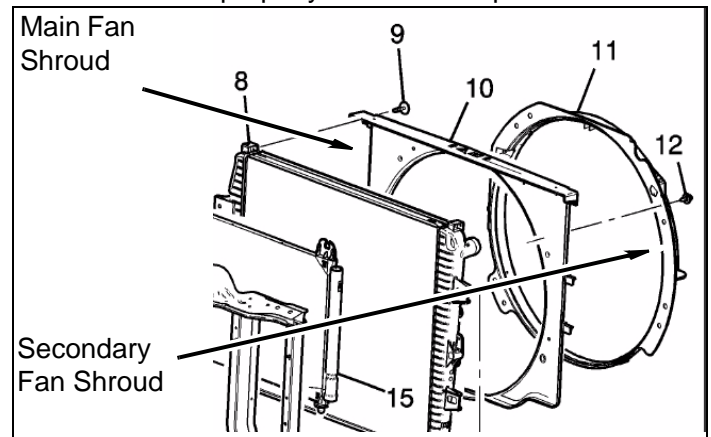

c. **Using fan clutch tool set, tighten fan clutch onto water pump pulley per OEM specs.

g. Reinstall positive battery cable into main shroud.

d. Reconnect fan clutch harness.

h. Install computer module on upper fan shroud with two pop-up clips.



Fan Clutch Harness

Fan Clutch

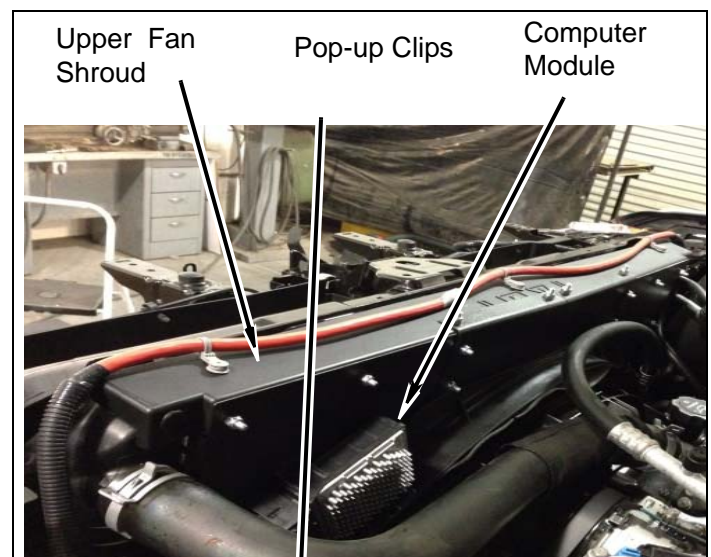

Upper Fan Shroud

Pop-up Clips

Computer Module

- i. Mark & Drill one 1/4" hole into lower most center section for fan shroud and use one **kit zip tie** to secure lower section of fan shroud to frame tube. Doing so will prevent the lower section of the fan shroud from backing away from the radiator.

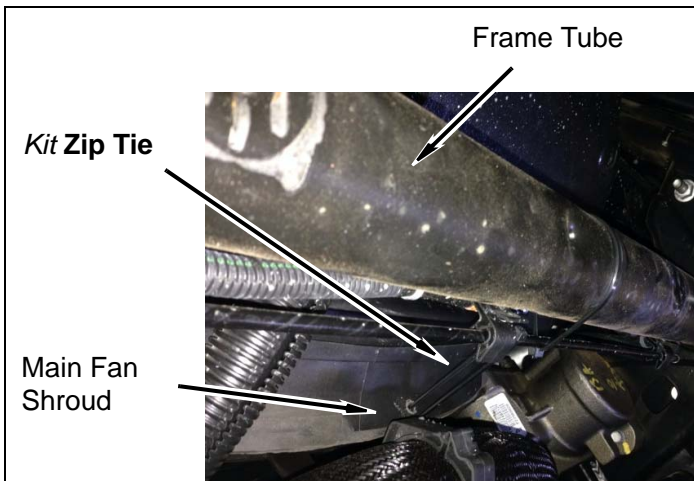

- j. Install Air Flap with three push pins into OEM location.

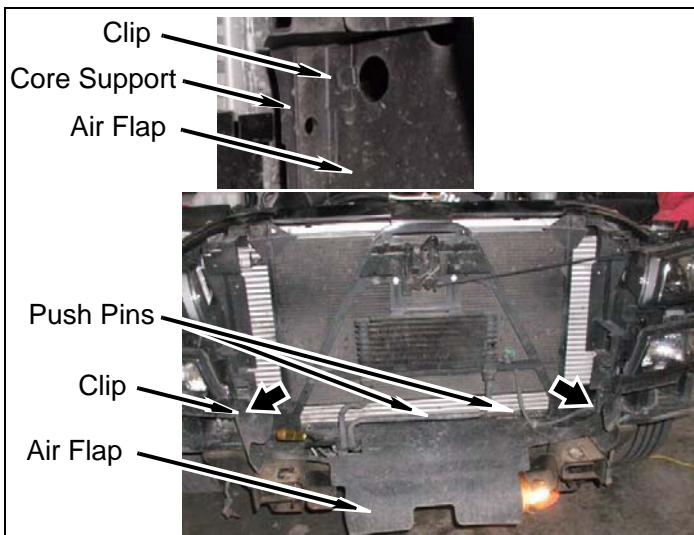

10. Air intake

- a. Install air box assembly in rubber grommets on fender and position air inlet hose on intake manifold.



- b. Tighten clamp on air intake assembly. Install wire harness clip on sensor.

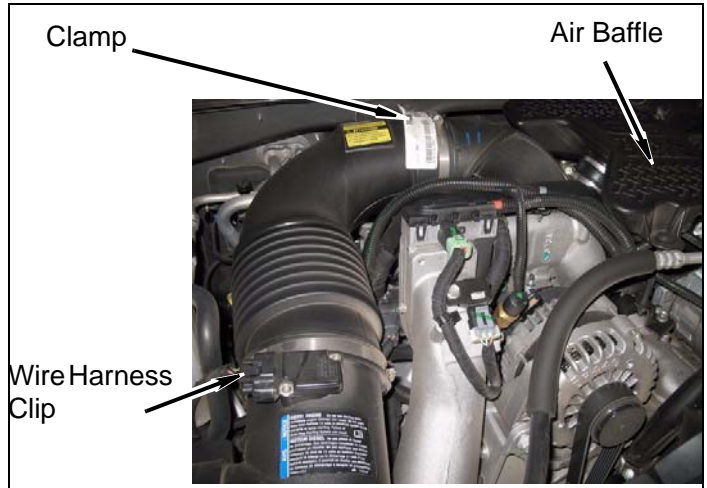

- c. Install A/C hose from clip on upper fan shroud.

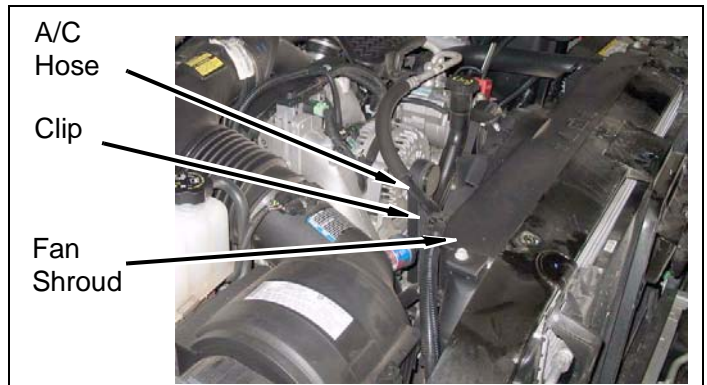

F. Front of vehicle

- 1. Plastic splash guard

- a. If removed, install clip and harness on air flap.
- b. Install plastic cover on frame and core support with five bolts.

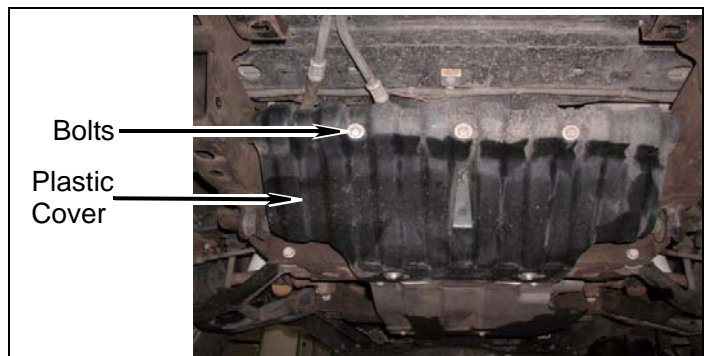

- 2. Front tow hook installation

- a. Measure and mark new tow hook **1/2"** hole position before drilling; 3" higher and 1/2" forward as shown below:

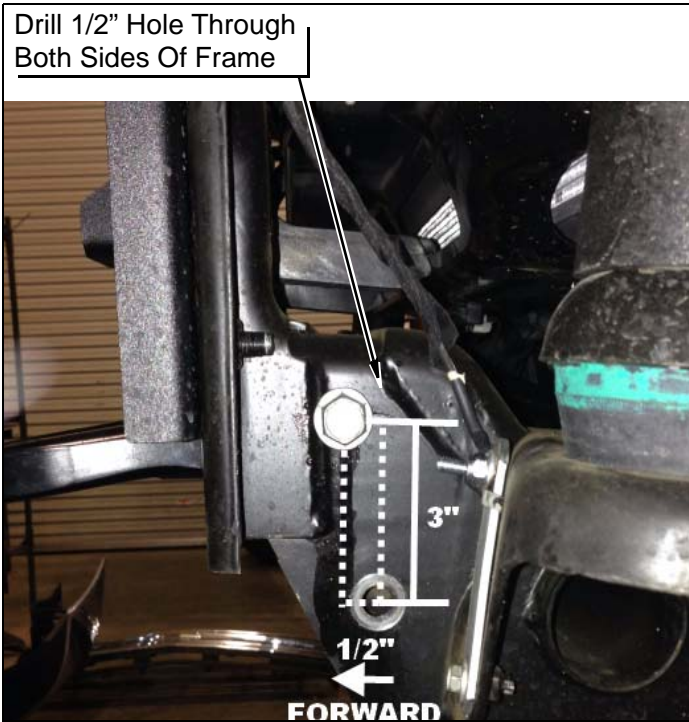

- b. Install OEM 12mm bolt through newly drilled hole and tow hook.
- c. Install one *kit sleeves* (.75" OD x .532" ID x 3.00" L), one *kit bolts* (M12-1.75 x 100mm), **washer** (12mm) through lower section of fame and tow hook. align and tighten hardware as shown below:



3. Install front bumper

- a. Place a few drops of kit Loctite® on threads of bolts.
- b. Install *kit bracket* (bumper, front, Dvr) and *kit bracket* (bumper, front, Psg) onto frame horns with four *OEM bolts* each. Center each bracket evenly and **TIGHTEN** OEM hardware.

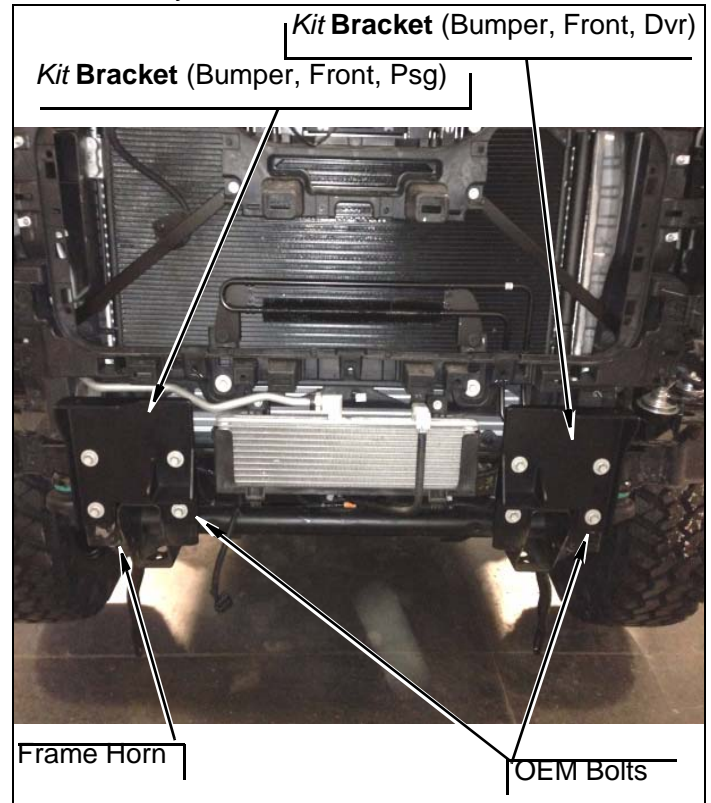

- c. Repeat above substeps for right frame horn.
- d. Install bumper onto frame brackets with four O.E. bolts, two OEM nuts and two *kit nuts* (12mm). **DO NOT TIGHTEN.**

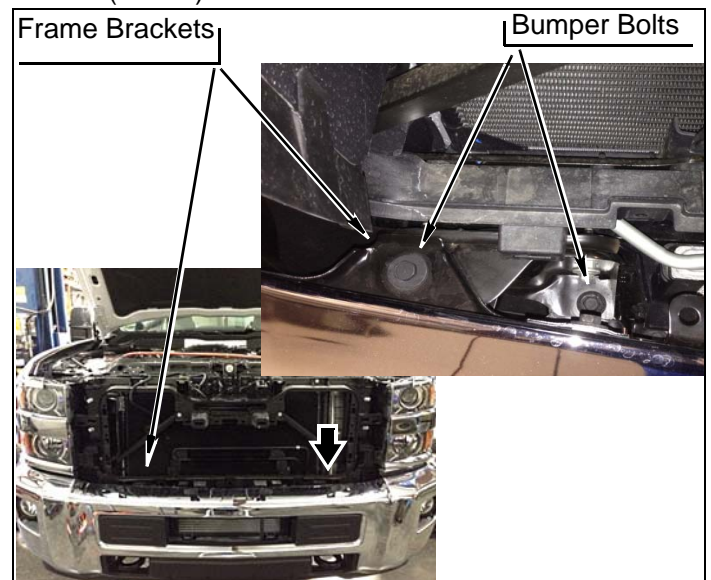

e.

- f. Install two **kit sleeves** (bumper, front, support) onto bumper with two **kit bolts** (M10-1.5 x 100mm) between bumper and OEM side support bracket. **DO NOT TIGHTEN**

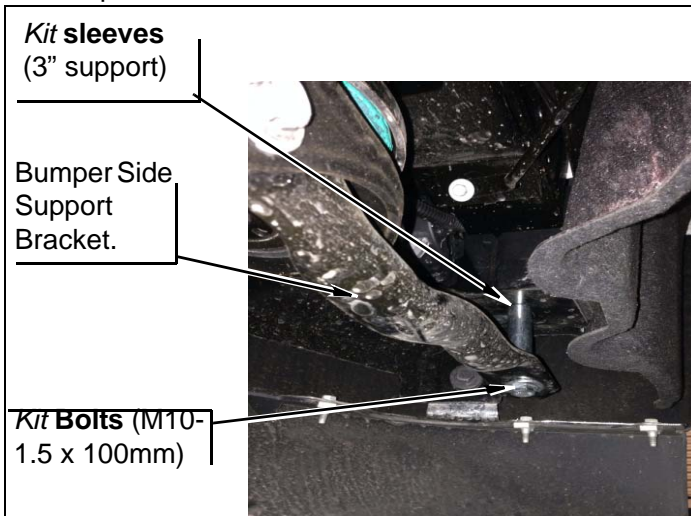

- g. Adjust bumper to body clearance using measurements from removal section. Align bumper to previous measurements and **TIGHTEN** all bumper hardware.

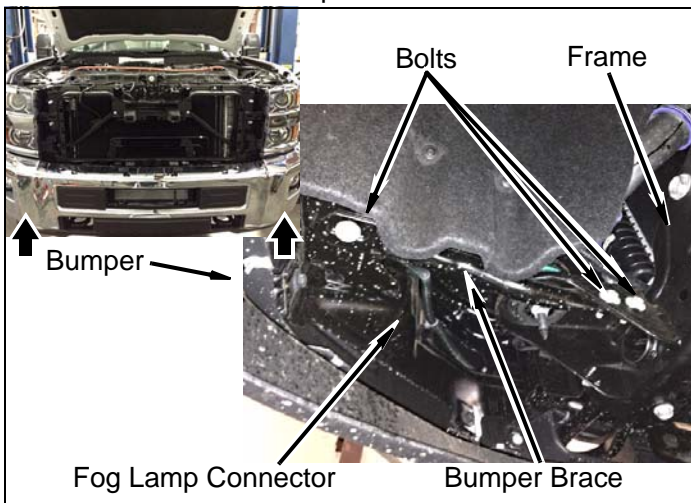

- h. If so equipped, install connectors for fog lamps.

4. Install Front Grille

- a. Position grill on core support and install six clips and four bolts in core support and front fender.



- b. Install cover on core support with seven push pins.

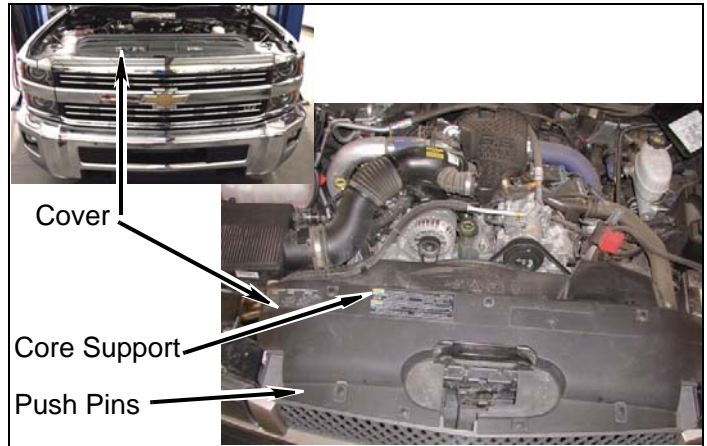

5. Install crush blocks

NOTE
Short wheel base trucks have two plastic disks and use two **kit** crush blocks.

- a. Remove four plastic disks from frame.
- b. Install four **kit crush blocks** on frame with four **kit washers** (5/16" USS) and four **kit screws** (5/16" x 3/4" self tapping).

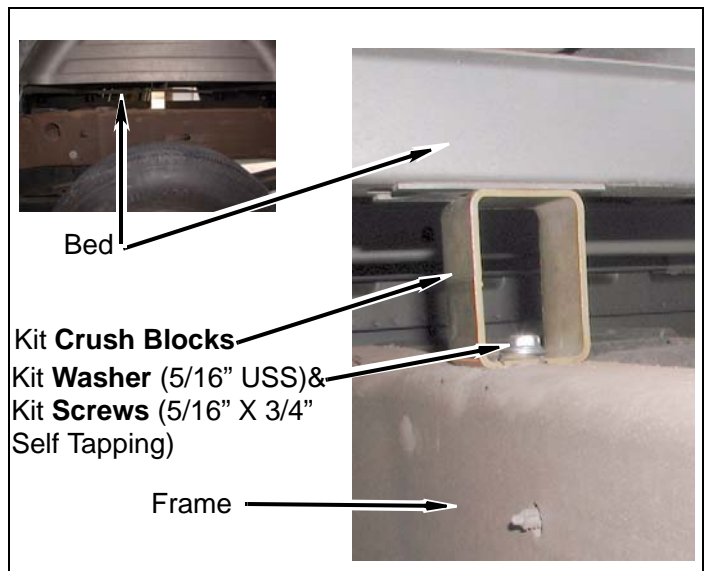

G. After installation is complete

1. Install airbag fuse in fuse panel. Install cover



2. Connect Battery

- a. Connect both battery cables to the battery. Be sure to reconnect the positive cables first, then the negative cables.

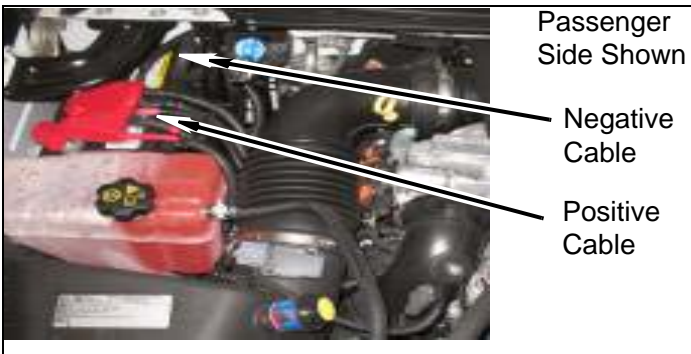

- b. Install *kit extension bracket* (L-bent) using OEM nut onto battery terminal fuse junction and *kit hardware* (5/16") at positive cable end as shown below:

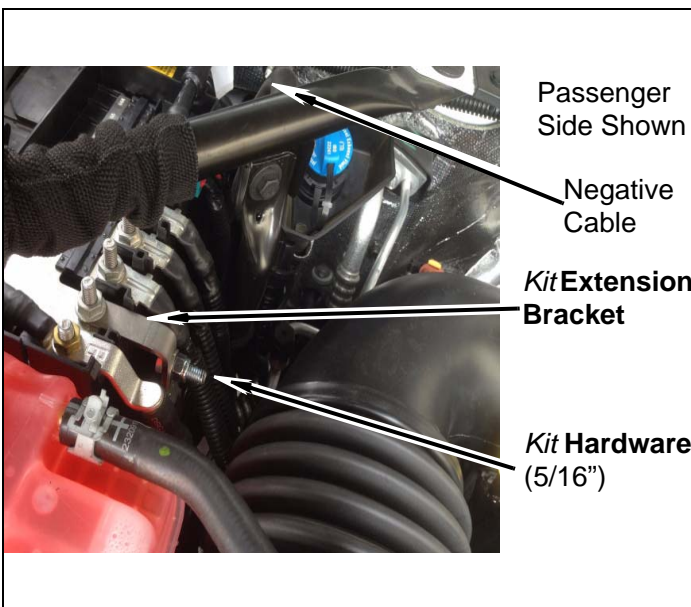

3. Install Gap Guards (you did remember to order your Gap Guards, didn't you?).
4. Stick kit **warning sticker** on the dash in plain sight of all vehicle occupants.
5. Double check the vehicle.

⚠CAUTION

Retorque all fasteners after 500 miles and after off road use. All body lift components should be visually inspected and fasteners re torqued during routine vehicle servicing.

- a. Check all mounting hardware to ensure it is properly tightened.
- b. Check all wires, hoses, cables, etc. to ensure they have been properly connected and there is ample slack. Check all belts and pulleys to ensure there is no rubbing or interference. With the number of hoses on this vehicle, it is vital that this be checked thoroughly.
- c. Check vehicle electrical system.
- d. Start vehicle and check the steering in both directions to ensure that there is no bind. Check clutch operation. Check the operation of the brake system and the parking brake. Check both shift levers' operation. Ensure that there is proper engagement in all gears and 4 wheel drive ranges.

⚠CAUTION

Never open a closed cooling system after the vehicle has been started. Only fill the cooling system if the cap has been removed while the vehicle was still cold.

- e. Check coolant level. Fill coolant to the proper level (refer to the Owner's Manual).

- f. Test drive vehicle in all gears and 4 wheel drive ranges. Pay close attention to all vehicle systems. Check all hardware again in 500 miles and as part of your regular maintenance schedule.

△NOTE

All warranty information, instruction sheets, and other documents regarding the installation of this product must be retained by the vehicle owner. Information contained in the instructions and on the warranty card will be required for any warranty claims. The vehicle owner needs to understand the modifications made to his vehicle and how they affect vehicle handling and performance. Failure to provide the customer with this information can result in damage to the vehicle and severe personal injury.

△CAUTION

Performance Accessories does not recommend any particular wheel and tire combinations for use with its body lifts and cannot assume responsibility for the customer's choice of wheels and tires. Reference your owner's manual for recommended tire sizes and warnings related to the use of oversized tires. Larger wheel and tire combinations increase stress and wear on steering and suspension components, which leads to increased maintenance and higher risk for component failure. Larger wheel and tire combinations also alter speedometer calibration, braking effectiveness, center of gravity, and handling characteristics. Consult with an experienced local off road shop to find what wheel and tire combinations work best with your vehicle.

H. PARTS LIST KIT 10313

QTY DESCRIPTION

16	Lift Block , round 3" x 3"
4	Bed Block , square 3" x 2" with hole
1	Bracket , front bumper dvr side
1	Bracket , front bumper psg side
1	Bracket , rear bumper dvr side
1	Bracket , rear bumper psg side
3	Bracket , fan shroud tabs (Z-bent)
1	Bracket , upper fan shroud center
1	Bracket , upper fan shroud dvr
1	Bracket , upper fan shroud psg
1	Bracket , lower fan shroud center
1	Bracket , lower fan shroud dvr
1	Bracket , lower fan shroud psg

2	Clamp , 3" Clamp
1	Loctite , tube
BOLT PACK	
6	Bolt , 14-2.00 x 180mm
2	Bolt , 12-1.75 x 200mm
8	Bolt , 12-1.75 x 100mm
1	Bolt , 3/8 x 1 3/4"
1	Nut , 3/8 Nylock
2	Washer , 3/8" SAE
8	Washer , 7/16" USS
10	Washer , 1/2" thick
1	Steering , extension
1	Bracket , parking cable extension

HARDWARE PACK

34	Bolt , 1/4 x 3/4
1	Bolt , 5/16 x 1
4	Bolt , 5/16 x 3/4 taper
2	Bolt , 7/16 x 1
2	Bolt , M10-1.5 x 100mm
2	Bolt , M12-1.75 x 100mm
40	Nut , 1/4 Nylock
1	Nut , 5/16 Nylock
2	Nut , 7/16 Nylock
2	Nut , M12 Flange
60	Washer , 1/4" SAE
6	Washer , 5/16" SAE
4	Washer , 7/16" SAE
2	Washer , M10
2	Washer , M12
4	Bracket , 3" w/ stud
2	Bracket , 2" w/ stud
1	Bracket , Battery Ground (L-bent)
4	Sleeve , (0.75" OD x 0.532" ID x 3.00" Long)
1	Pin , 4x4 extension (1/2" X 1")
6	Zip tie
2	Push Pin , 1/4"